





THE MEINL BOOK OF PERCUSSION 2023

THE ULTIMATE SELECTION



meinpercussion.com

THE ULTIMATE SELECTION



meinpercussion.com

THE ULTIMATE SELECTION



THE ULTIMATE SELECTION OF PERCUSSION

THE ULTIMATE SELECTION

THE ULTIMATE SELECTION



meinlpercussion.com

meinlpercussion.com

meinlpercussion.com





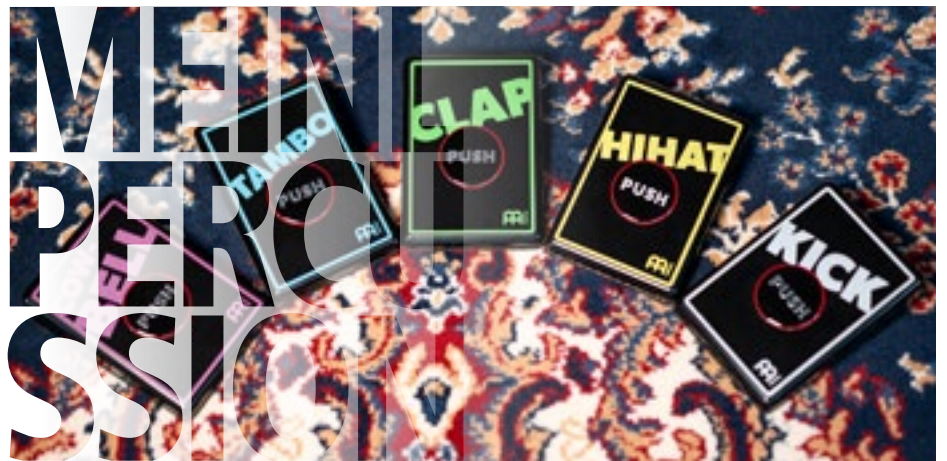

B

Bags	106
Blocks	22
Bongos	62
Bongo Cajons	42/46
Brushes/Beaters	35/47/94

C

Cabasas	24
Caixas	83
Cajons	38
Cajons, Bass	43
Cajons, Pickup	44
Cajons, Slaptop	42
Cajon Add-Ons	52
Cajon Drum Sets	48
Cajon Pedals	47
Castanets	23
Chimes	32
Ching Rings	11
Claves	23
Congas	66
Cowbells	20

D

Darbukas	78
Didgeridoos	28
Djembes	54
Djembe, Pickup	57
Djembes, Synthetic	54
Djembes, Wood	58
Doumbeks	79
Drum Circle Bags	93
Drum Circle Bass Drums	91
Drum Circle Cajons	88
Drum Circle Congas	90
Drum Circle Djembes	89
Drum Circle Hand Percussion	92
Drum Circle Stack Drum Sets	92
Drum Circle Timbas	92
Drum Rugs	111

F

Foot Percussion	34
Frame Drums	84

G

Güiros	22
Güiras	25

H

Hand Drums	84
Hand Percussion	06
Hardware	102

I

Ibo Drums	86
-----------	----

J

Jingle Sticks	12
---------------	----

K

Kalimbas	24
----------	----

M

Mallets	94
Maracas	19

P

Pandeiros	13
Pickup Accessories	45/50

R

Rainsticks/Rainmaker	30
Ritual Drums	86
Riq Drum	13

S





Samba	25/80
Shakers	14/25
Shekeres	87
Sound Effects	26
Stands	96
Sticks/Scrapers	94
Stomp Boxes	34
Surdos	80

T

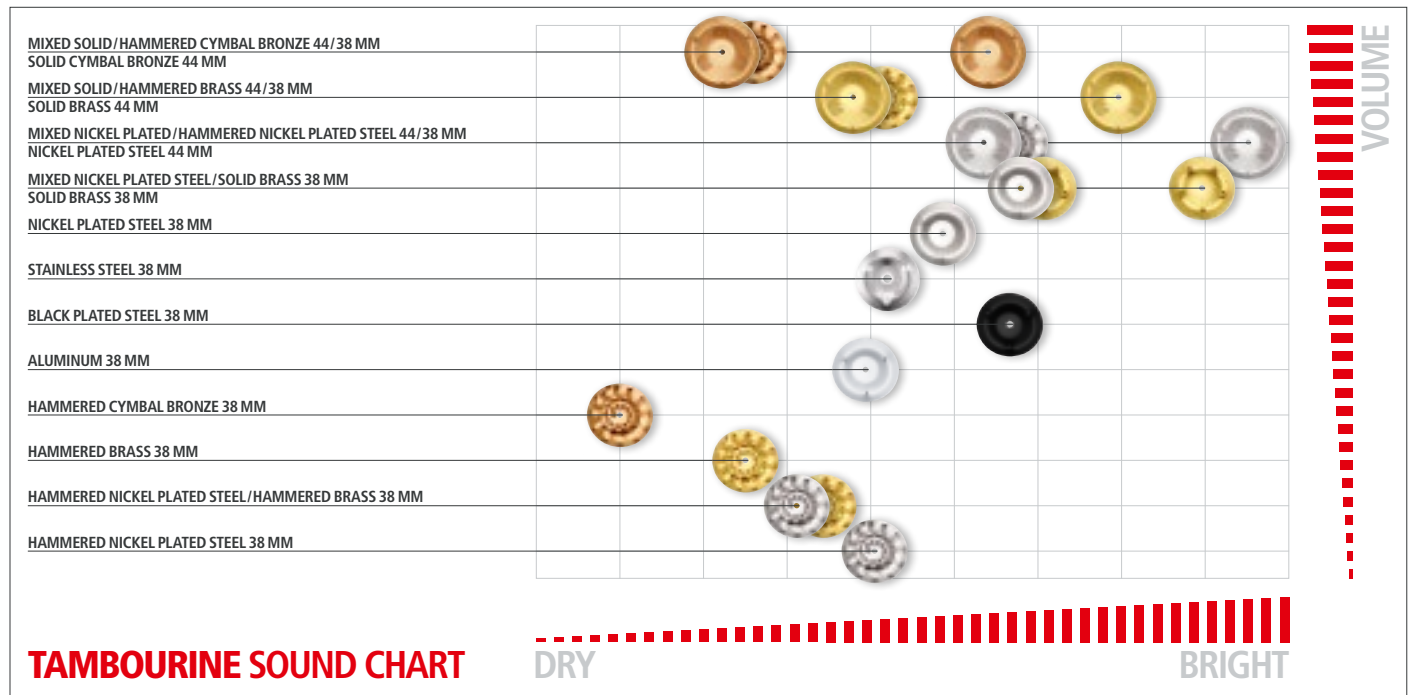
Tables	100
Tamborims/Tampeiro	83
Tambourines	06/15
Tamburello	08
Timbales	76
Triangles	26

COMPACT WOOD TAMBOURINES



<p>1</p>  <p>HAMMERED CYMBAL BRONZE</p> <p>3 rows AE-CMTA3BO</p>	<p>2</p>  <p>SOLID BRASS</p> <p>2 rows CTA2B-BK</p>	 <p>MIXED NICKEL PLATED STEEL / SOLID BRASS</p> <p>2 rows CTA2M-BK</p>	 <p>NICKEL PLATED STEEL</p> <p>2 rows CTA2S-BK</p>
 <p>HAMMERED BRASS</p> <p>3 rows AE-CMTA3B</p>	 <p>HAMMERED NICKEL PLATED STEEL</p> <p>3 rows AE-CATA3S</p>	 <p>MIXED HAMMERED NICKEL PLATED STEEL / BRASS</p> <p>2 rows CTA2VM-WB</p>	 <p>STAINLESS STEEL</p> <p>2 rows CTA2WB</p>

1 ARTISAN EDITION COMPACT TAMBOURINES

SIZE 8"

MATERIALS **AE-CATA3:** American White Ash (*Fraxinus americana* L.)
AE-CMTA3: Maple (*Adcer* sp.)
B: Hammered brass jingles
BO: Hammered cymbal bronze jingles
S: Hammered nickel plated steel jingles

FEATURES Total unique tambourine sounds; Resounding jingle accents; Special profile jingles; Ergonomic hand grip; Detailed with ornamental heat-branded logo; 3 rows of hammered jingles; Extra narrow jingle slots for precise playing

2 COMPACT WOOD TAMBOURINES

SIZE 8"

MATERIALS Wooden frame
CTA2B-BK: Solid brass jingles
CTA2M-BK: Nickel plated steel / solid brass jingles
CTA2S-BK: Nickel plated steel jingles
CTA2VM-WB: Hammered nickel plated steel / hammered brass jingles
CTA2WB: Stainless steel jingles

FEATURES Compact size; 2 row version

COLOURS
BK: Black
WB: Walnut Brown

WOOD TAMBOURINES



TAMBOURINES

1

1 row **AE-MTA1BO** 2 rows **AE-MTA2BO**

SOLID CYMBAL BRONZE 44 MM

1 row **AE-MTA1B** 2 rows **AE-MTA2B**

SOLID BRASS 44 MM

1 row **AE-ATA1S** 2 rows **AE-ATA2S**

NICKEL PLATED STEEL 44 MM

2

1 row **TA1V-WB** 2 rows **TA2V-WB**

HAMMERED BRASS

1 row **TA1B-AB** 2 rows **TA2B-AB**

SOLID BRASS

1 row **TA1AB** 2 rows **TA2AB**

NICKEL PLATED STEEL

1 row **TA1VM-WB** 2 rows **TA2VM-WB**

MIXED HAMMERED NICKEL PLATED STEEL / BRASS

1 row **TA1WB** 2 rows **TA2WB**

STAINLESS STEEL

1 row **TA1A-AB** 2 rows **TA2A-AB**

ALUMINUM

4

1 row **TA1M-SNT** 2 rows **TA2M-SNT**

MIXED NICKEL PLATED STEEL / SOLID BRASS

1 ARTISAN EDITION TAMBOURINES

SIZE 10"
 MATERIALS **AE-ATA:** American White Ash (*Fraxinus americana* L.)
AE-MTA: Maple (*Adcer* sp.)
B: Solid brass jingles
BO: Solid cymbal bronze jingles
S: Nickel plated steel jingles
 FEATURES Total unique tambourine sounds; Resounding tambourine accents; Special profile jingles; Ergonomic hand grip; Detailed with ornamental heat-branded logo; 1 row and 2 row version

2 VINTAGE WOOD TAMBOURINES

SIZE 10"
 MATERIALS Wooden frame
TA1V: Hammered brass jingles
TA1VM: Hammered nickel plated steel / hammered brass jingles
 FEATURES Legendary tambourine sound; Special profile jingles; Detailed with heat-branded logo; 1 row and 2 row version
 COLOUR **WB:** Walnut Brown

3 TRADITIONAL WOOD TAMBOURINES

SIZE 10"
 MATERIALS Wooden frame
TA1A-AB, TA2A-AB: Aluminum jingles
TA1B-AB, TA2B-AB: Solid brass jingles
TA1AB, TA2AB: Nickel plated steel jingles
TA1WB, TA2WB: Stainless steel jingles
 FEATURES 1 row and 2 row version
TA1WB, TA2WB: Detailed with heat-branded logo
 COLOURS **AB:** Antique Brown
WB: Walnut Brown

4 RECORDING-COMBO WOOD TAMBOURINES

SIZE 10"
 MATERIALS Wooden frame
 Nickel plated steel / solid brass jingles
 FEATURES Dual-alloy jingles; 1 row and 2 row version
 COLOUR **SNT:** Super Natural

HEADED WOOD TAMBOURINES



1 HEADED ARTISAN EDITION TAMBOURINES

SIZE 10"

MATERIALS Hand selected calfskin heads
AE-ATAH: American White Ash (*Fraxinus americana* L.)
AE-MTAH: Maple (*Adcer sp.*)
B: Solid / hammered brass jingles
BO: Solid / hammered cymbal bronze jingles
S: Nickel plated / hammered nickel plated steel jingles

FEATURES Total unique tambourine sounds; Resounding jingle accents; Two different profile jingles; Ergonomic hand grip; Detailed with ornamental heat-branded logo; Prepared with Resin

2 TAMBURELLO

SIZE 12"

MATERIALS Wooden frame; Hand selected goatskin head; Aluminum jingles

FEATURES 2 row version; Detailed with heat-branded logo; Total unique tambourine sounds

3 VINTAGE GOATSKIN WOOD TAMBOURINES

SIZE 10"

MATERIALS Wooden frame; Hand selected goatskin heads; Hammered brass jingles

FEATURES 1 row and 2 row version; Detailed with heat-branded logo

COLOUR **WB:** Walnut Brown

4 TOURING SYNTHETIC HEAD WOOD TAMBOURINES

SIZE 10"

MATERIALS Wooden frame; True Feel synthetic heads; Black plated steel jingles

FEATURE 1 row and 2 row version
COLOUR **R:** Red

5 RECORDING-COMBO GOATSKIN WOOD TAMBOURINES

SIZE 10"

MATERIALS Wooden frame; Hand selected goatskin heads; Nickel plated steel / solid brass jingles

FEATURES Dual-alloy jingles; 1 row and 2 row version

COLOUR **SNT:** Super Natural

6 TRADITIONAL GOATSKIN WOOD TAMBOURINES

SIZE 10"

MATERIALS Wooden frame; Hand selected goatskin heads
TAH1A-AB, TAH2A-AB: Aluminum jingles

HAND HELD ABS TAMBOURINES



TAMBOURINES

7

1 row, 8" **HTT8BK** 2 rows, 10" **HTT10BK** 1 row, 8" **HTT8R** 2 rows, 10" **HTT10R** 1 row, 8" **HTT8WH** 2 rows, 10" **HTT10WH**

NEW

STAINLESS STEEL

8

1 row **HTBK** 2 rows **HTMT1BK** 1 row **HTR** 2 rows **HTMT1R** 1 row **HTWH** 2 rows **HTMT1WH**

NEW

STAINLESS STEEL

9

2 rows **TMT1B-BK** 2 rows **TMT1BK** 2 rows **TMT1R** 2 rows **TMT1A-B**

SOLID BRASS

NICKEL PLATED STEEL

NICKEL PLATED STEEL

ALUMINUM

10

2 rows **TMT1M-BK** 2 rows **TMT1M-WH**

NEW

MIXED NICKEL PLATED STEEL / SOLID BRASS

TAH1B-AB, TAH2B-AB:

Solid brass jingles

TAH1AB, TAH2AB:

Nickel plated steel jingles

TAH1WB, TAH2WB:

Stainless steel jingles

FEATURES 1 row and 2 row version

TAH1WB, TAH2WB: Detailed with heat-branded logo

COLOURS **AB:** Antique Brown

WB: Walnut Brown

7 HEADLINER® SERIES TOUR TAMBOURINES

SIZES **HTT8:** 8"
HTT10: 10"

MATERIALS Molded ABS; Stainless steel jingles

FEATURES Handheld; Extra wide grip; Bright, cutting sound; Durable frame

HTT8: 1 row version; Compact size

HTT10: 2 row version

COLOURS **BK:** Black

R: Red

WH: White

8 HEADLINER® SERIES HAND HELD ABS TAMBOURINES

MATERIALS Molded ABS; Stainless steel jingles

FEATURES Ergonomic hand grip for more playing comfort; Güiro style playing surface; Penetrating jingle sound

HT: 1 row version

HTMT1: 2 row version

COLOURS **BK:** Black

R: Red

WH: White

9 TRADITIONAL HAND HELD ABS TAMBOURINES

MATERIALS Molded ABS

TMT1A-B: Aluminum jingles

TMT1B-BK: Solid brass jingles

TMT1BK, TMT1R: Nickel plated steel jingles

FEATURES Padded soft grip for more playing comfort; Ergonomic design; Güiro style playing surface; "Sandwich" construction

COLOURS **B:** Blue

BK: Black

R: Red

10 RECORDING-COMBO HAND HELD ABS TAMBOURINES

MATERIALS Molded ABS; Nickel plated steel / solid brass jingles

FEATURES Padded soft grip for more playing comfort; Ergonomic design; Güiro style playing surface; "Sandwich" construction

COLOURS **BK:** Black

WH: White

MOUNTABLE ABS TAMBOURINES

1



2 rows
HTMT2BK

NEW



2 rows
HTMT2R

NEW



2 rows
HTMT2WH

STAINLESS STEEL

2



2 rows
TMT2B-BK

SOLID BRASS



2 rows
TMT2BK

NICKEL PLATED STEEL



2 rows
TMT2R

NICKEL PLATED STEEL



2 rows
TMT2A-B

ALUMINUM

3



2 rows
TMT2M-WH

MIXED NICKEL PLATED STEEL / SOLID BRASS



1 HEADLINER® SERIES MOUNTABLE ABS TAMBOURINES

MATERIALS Molded ABS
Stainless steel jingles

FEATURES Easy mountable
Güiro style playing surface
Penetrating jingle sound

COLOURS **BK:** Black
R: Red
WH: White

2 TRADITIONAL MOUNTABLE ABS TAMBOURINES

MATERIALS Molded ABS
TMT2A-B: Aluminum jingles
TMT2B-BK: Solid brass jingles
TMT2BK, TMT2R: Nickel plated steel jingles

FEATURES Easily mountable
Ergonomic design
Güiro style playing surface
"Sandwich" construction

COLOURS **B:** Blue
BK: Black
R: Red

3 RECORDING-COMBO MOUNTABLE ABS TAMBOURINE

MATERIALS Molded ABS
Nickel plated steel / solid brass jingles

FEATURES Easily mountable
Ergonomic design
Güiro style playing surface
"Sandwich" construction

COLOUR **WH:** White

CHING RINGS & HIHAT TAMBOURINES



TAMBOURINES



SFHHT



Ching Ring
CRING

STAINLESS STEEL



Dry Ching Ring
DCRING

ZINC



Soft Ching Ring
SCRING

STAINLESS STEEL



1 row
HTHHBG

SAND HIHAT TAMBOURINE
DESIGNED WITH BENNY GREB



1 row
HTHH1B-BK

HAMMERED BRASS



2 rows
HTHH2B-BK

HAMMERED BRASS



1 row
HTHH1BK

STAINLESS STEEL



2 rows
HTHH2BK

STAINLESS STEEL

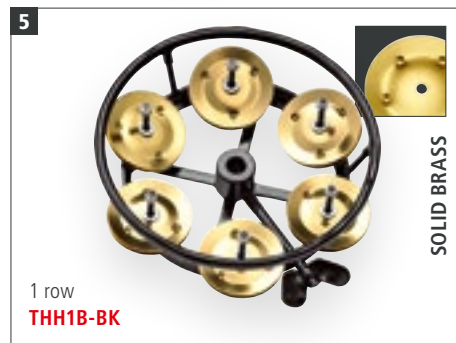

1 row
THH1B-BK

SOLID BRASS



1 row
THH1BK

STAINLESS STEEL

1 SUPER FLEX HIHAT TAMBOURINE
SIZE 4.3" inner diameter, 9.5" outer diameter
MATERIALS Mylar frame
 10 pairs of stainless steel jingles
FEATURES Super flex frame produces enhanced hihat tambourine accents
 10 pairs of stainless steel jingles deliver a clear and bright sound
 Extra-wide 9.5" shape gives you outstanding foot response
 Shines through the mix to easily blend a tambourine effect into your grooves

2 CHING RINGS
SIZE 6"
MATERIALS **CRING**
 Steel ring
 5 pairs of stainless steel jingles

DCRING
 Steel ring
 5 pairs of zinc jingles
SCRING
 Foam ring
 6 pairs of stainless steel jingles
FEATURES Fits on most cymbals
 Quick setup

3 BENNY GREB SAND HIHAT TAMBOURINE
SIZE 5"
MATERIAL Sand blasted brass jingles
FEATURES Benny Greb signature hihat tambourine
 Eight pairs of sand blasted brass jingles
 Dry, vintage sound with unique matte appearance
 Blends easily into your natural drum set or percussion mix
 Wing nut design fits on any hihat rod

4 HEADLINER® SERIES HIHAT TAMBOURINES
SIZE 5"
MATERIALS **HTHH1BK, HTHH2BK:**
 Stainless steel jingles
HTHH1B-BK, HTHH2B-BK:
 Hammered brass jingles
FEATURE 1 row and 2 row version

5 PROFESSIONAL SERIES HIHAT TAMBOURINES
SIZE 5"
MATERIALS **THH1BK:** Stainless steel jingles
THH1B-BK: Solid brass jingles
FEATURE Rubber padded surface

CRASHERS, BACKBEAT TAMBOURINES & JINGLE STICKS



Medium
CRASHER-M

Large
CRASHER



10" - 12"
BBT1-BK

13" - 14"
BBT2-BK



13"
BBP13

14"
BBP14



HJS1BK

HJS1R



JG1B-BK

JG1R



JG1M-WH

JG1A-B



JG1BK

MJS1BK

1 TURBO CRASHERS

SIZES **CRASHER-M**: Medium
CRASHER: Large
MATERIAL Steel
FEATURES Güiro style playing surface; Cutting sound; Easy mountable

2 BACKBEAT TAMBOURINES

SIZES **BBT1-BK**: For 10" and 12" drums
BBT2-BK: For 13" and 14" drums
MATERIALS Eco-friendly medium density fiberboard; Stainless steel jingles
FEATURES Fits on any standard drum; Adds a tambourine sound to the groove; Hook and loop fastener
COLOUR **BK**: Black

3 BACKBEAT PRO TAMBOURINES

SIZES **BBP13**: 13"
BBP14: 14"

MATERIALS Cymbal brass alloy ring; Solid brass jingles
FEATURES Blackened brass ring made from MEINL Cymbal Alloy; Eight pairs of solid brass jingles

4 HEADLINER® SERIES JINGLE STICKS

MATERIALS Molded ABS; Stainless steel jingles
COLOURS **BK**: Black
R: Red

5 PROFESSIONAL SERIES JINGLE STICKS

MATERIALS Molded ABS
JG1: Nickel plated steel jingles
JG1A: Aluminum jingles
JG1B: Solid brass jingles
JG1M: Nickel plated steel / solid brass jingles
FEATURES Padded grip; Güiro style playing surface

6 MULTI-JINGLE STICK

MATERIALS Molded ABS; Nickel plated steel / solid brass jingles
FEATURES Jingles mounted on two intersecting planes; Padded grip; Special playing techniques

7 ARTISAN EDITION RIQ DRUM

SIZE 8 3/4"
MATERIALS Wooden frame; Synthetic head; Ten pairs of brass jingles
FEATURES Artisan sounds for Arabic folk and classical music; Five tuning lugs
INCLUDES Tuning key; Bag
FINISH White Pearl Mosaic Royal

8 TRADITIONAL ABS PANDEIROS

SIZE 10"
MATERIALS Molded ABS; Chrome plated steel jingles
PA10ABS-BK
Replaceable synthetic head

ARTISAN EDITION RIQ DRUM & PANDEIROS



7

Synthetic head, 8 3/4"
AERIQ1

8

CHROME PLATED STEEL JINGLES

Clear Mylar head, 10"
PA10ABS-BK

Napa head, 10"
PA10ABS-BK-NH

9

CHROME PLATED STEEL JINGLES

Poplar Wood, 10"
PA10PW-M

Siam Oak, 10"
PA10CN-M

10

HAND-HAMMERED BRASS JINGLES

Goatskin head, 10"
PA10AB-M

PERFORATED HAND-HAMMERED BRASS JINGLES

True Feel synthetic head, 10"
PAV10AB-M-TF

Siam Oak, 12"
PA12CN-M

11

UNIQUE SHAKER PODS

Napa head, 10"
PAS10PW-NH

12

EASY MOUNTABLE

Napa head, 10"
PA10A-BK-NH-H

13

EASY MOUNTABLE

True Feel synthetic head, 12"
PA12CN-M-TF-H

PA10ABS-BK-NH
Replaceable Napa head
Countersunk bolt lugs

PA10ABS-BK: Logo applied from underneath the head (CN, TH, US patent)

PA10ABS-BK-NH: Reduced overtones

INCLUDES: Tuning key
COLOUR: **BK:** Black

9 TRADITIONAL WOOD PANDEIROS

SIZES: **PA10:** 10"
PA12: 12"

MATERIALS: Replaceable hand selected goatskin head; Chrome plated steel jingles
PA10CN-M, PA12CN-M
Siam Oak (*Hevea brasiliensis* Muell.-Arg.)
PA10PW-M
Poplar Wood (*Populus*)

INCLUDES: Tuning key
COLOUR: **CN-M:** Chestnut, matte

10 SHELL-TUNED PANDEIROS

SIZE: 10"

MATERIALS: Siam Oak (*Hevea brasiliensis* Muell.-Arg.)
PA10AB-M
Hand selected goatskin head; Hand-hammered brass jingles
PAV10AB-M-TF
True Feel synthetic head; Perforated hand-hammered brass jingles for extra dry sound

INCLUDES: Hex key
COLOUR: **AB-M:** Antique Brown, matte

11 SHAKER PANDEIRO

SIZE: 10"

MATERIALS: Poplar Wood (*Populus*); Replaceable Napa head; Aluminum shaker pods

FEATURE: Countersunk bolt lugs

INCLUDES: Tuning key

12 TRADITIONAL ABS PANDEIRO WITH HOLDER

SIZE: 10"

MATERIALS: Molded ABS; Replaceable Napa head; Chrome plated steel jingles

FEATURES: Countersunk bolt lugs; Reduced overtones; Easy mountable

INCLUDES: Tuning key
COLOUR: **BK:** Black

13 TRADITIONAL WOOD PANDEIRO WITH HOLDER

SIZE: 12"

MATERIALS: Siam Oak (*Hevea brasiliensis* Muell.-Arg.); Replaceable True Feel synthetic head; Chrome plated steel jingles

FEATURES: Countersunk bolt lugs; Reduced overtones; Easy mountable

INCLUDES: Tuning key
COLOUR: **CN-M:** Chestnut, matte

ARTIST SERIES SHAKERS, PERC PACK, EGG SHAKERS,

<p>1</p> <p>SOFT: STUDIO</p>  <p>Studio shaker, Red SH5R</p> <p>72 - 76 DB</p>	<p>MEDIUM: LIVE</p>  <p>Live shaker, Black SH4BK</p> <p>79 - 81 DB</p>	<p>NEW</p> <p>MEDIUM: LIVE</p>  <p>Live shaker, Creamsicle SH4CS</p>	<p>NEW</p> <p>MEDIUM: LIVE</p>  <p>Live shaker, Electric Coral SH4EC</p>
<p>NEW</p> <p>MEDIUM: LIVE</p>  <p>Live shaker, Glacier Blue SH4GB</p>	<p>NEW</p> <p>MEDIUM: LIVE</p>  <p>Live shaker, Seafoam Green SH4SF</p>	<p>NEW</p> <p>MEDIUM: LIVE</p>  <p>Live shaker, White SH4WH</p>	<p>LOUD: STADIUM</p>  <p>Stadium shaker, Grey SH45GR</p> <p>88 - 93 DB</p>

2 **NEW**



MSS

3



Set, 3 pcs.
PP-1

4 **NEW**



Set, 4 pcs.
ES-SET-2

5

SOFT

MEDIUM

LOUD

EXTRA LOUD



Set, 4 pcs.
ES-SET

6

Black
ES2-BK

Red
ES2-R

Blue
ES2-B

Yellow
ES2-Y

Green
ES2-GREEN

COMES IN A SET OF TWO



1 ARTIST SERIES SHAKERS LUIS CONTE

SIZE Medium

MATERIAL Synthetic

FEATURES Two individual shakers connected as one instrument

SH4: Perfect for live playing

SH45: Perfect for stadium situations

SH5: Perfect for studio recordings

COLOURS

BK: Black

CS: Creamsicle

EC: Electric Coral

GB: Glacier Blue

GR: Grey

R: Red

SF: Seafoam Green

WH: White

2 LUIS CONTE SHAKER WITH STRAPS

SIZE Medium

MATERIAL Synthetic

FEATURES Strap to a drumstick to get shaker sounds as you play

Add new sonic layers to your drum set grooves

COLOUR **BK:** Black

INCLUDES Two durable rubber straps

3 PERC PACK

CONTAINS Compact Foot Tambourine

Luis Conte Live Shaker

Classic Wood Claves

FEATURES Compact Foot Tambourine for hands free use

Luis Conte Live Shaker for smooth sound

Classic Wood Claves for traditional rhythms

4 EGG SHAKER ASSORTMENT

MATERIAL Synthetic

FEATURES Four-piece egg shaker set ideal for any percussion set up

Designed for four different volume levels

Colour coded for easy identification

Easily transportable

5 EGG SHAKER SET

MATERIAL Synthetic

FEATURE Range of volume from soft to extra loud

6 EGG SHAKER PAIRS

MATERIAL Synthetic

FEATURE Comes in a set of two

COLOURS

B: Blue

BK: Black

GREEN: Green

R: Red

Y: Yellow

FACE SHAKERS, KEY RING SHAKERS & TAMBOURINES



SHAKERS

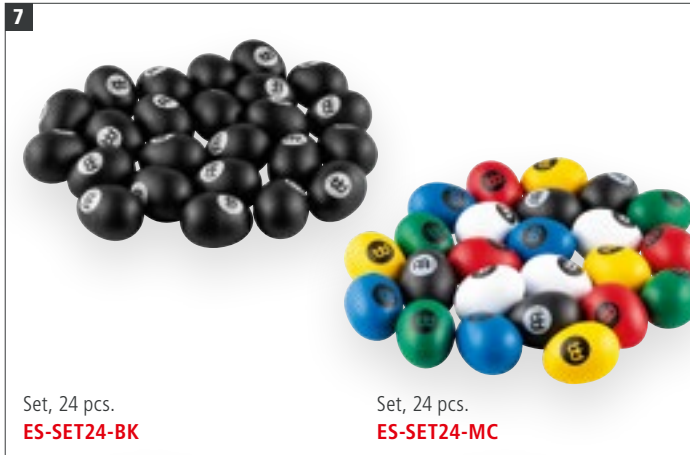

Set, 24 pcs.
ES-SET24-BK

Set, 24 pcs.
ES-SET24-MC



Set, 60 pcs.
ES-BOX



Happy Face
FACE-H

Laughing Face
FACE-L

Poop Face
FACE-P

Sad Face
FACE-S



Face Shaker Assortment, 24 pcs.
FSA1

Face Shaker Assortment, 4 pcs.
FSA4



Key Ring Tambourine, red
KRT-R

Key Ring Tambourine, black
KRT-BK

Key Ring Shaker and Tambourine Assortment
KRA1

Key Ring Shaker, grey
KRS-GR

Key Ring Shaker, black
KRS-BK

7 EGG SHAKER SETS OF 24 PCS.

MATERIAL Synthetic
FEATURES Crystal clear shaker sounds
Durable shells
Great for group or classroom percussion
COLOURS **BK:** Black
MC: Multi-colour

8 EGG SHAKER BOX

CONTAINS Holds 60 Egg Shakers:
20 x Egg Shaker, Blue (B)
10 x Egg Shaker, Black (BK)
10 x Egg Shaker, Green (GREEN)
10 x Egg Shaker, Red (R)
10 x Egg Shaker, Yellow (Y)

9 FACE SHAKERS

MATERIAL Molded ABS
CONTAINS **FSA1**
6 x Happy Face
6 x Laughing Face
6 x Poop Face
6 x Sad Face
FSA4
1 x Happy Face
1 x Laughing Face
1 x Poop Face
1 x Sad Face
FEATURES Made of durable molded ABS
Loud filling projects clearly
Great accent for live and studio applications
INCLUDES **FSA1:** Fishbowl

GRAPHICS **FACE-H:** Happy Face
FACE-L: Laughing Face
FACE-P: Poop Face
FACE-S: Sad Face

10 KEY RING SHAKERS & KEY RING TAMBOURINES

MATERIALS Molded ABS
KRT: Nickel plated steel
CONTAINS **KRA1**
10 x Key Ring Shaker
8 x Key Ring Tambourine
FEATURES Easily detach when it's time to play
Perfect for acoustic shows or jam sessions
INCLUDES **KRA1:** Fishbowl
FINISHES **BK:** Black
GR: Grey
R: Red

SYNTHETIC, FIBERGLASS & ALUMINUM SHAKERS

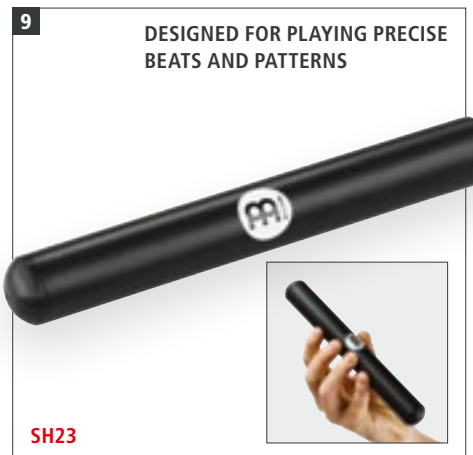
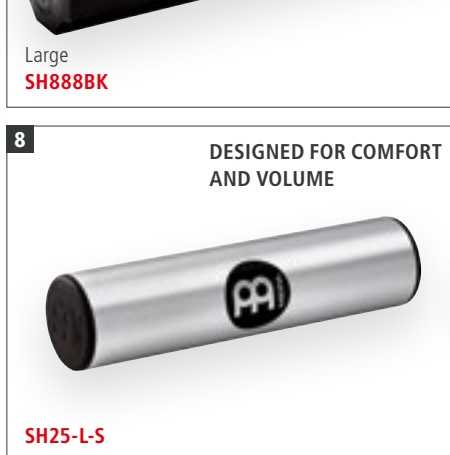
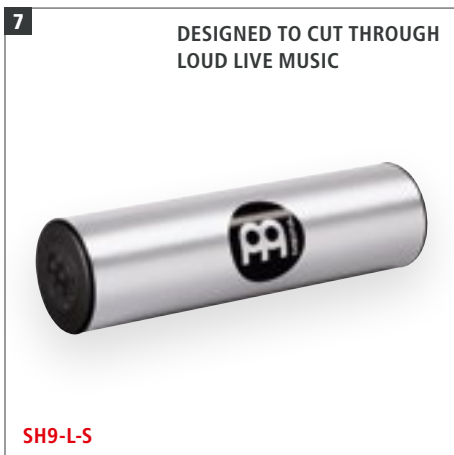

1 STUDIO SHAKERS

SIZES **SH10-M-BK**: Medium
SH10-L-BK: Large

MATERIAL Synthetic

FEATURE Deliver a very tasteful and delicate shaker sound with a warm tone and well balanced frequency spectrum

COLOUR **BK**: Black

2 STUDIOMIX SHAKERS

SIZES **SH12-M-BK**: Medium
SH12-L-BK: Large

MATERIAL Synthetic

FEATURE Textured surface for special sound and positive grip

COLOUR **BK**: Black

3 CRYSTAL SHAKERS

SIZE Large

MATERIALS Synthetic; Acrylic

FEATURES Shapes any groove with clarity and feel
SH26-L-L: Perfect for live playing
SH26-L-S: Perfect for studio recordings

4 FIBERGLASS SHAKER

SIZE Large

MATERIAL Premium fiberglass

FEATURE Made from premium fiberglass for more durability and better sound quality

COLOUR **BK**: Black

5 ALUMINUM SHAKERS, OCTAGONAL

SIZES **SH8BK**: Small
SH88BK: Medium
SH888BK: Large

MATERIAL Aluminum

FEATURE Provides a broad dynamic range with lots of volume

COLOUR **BK**: Black

6 ALUMINUM JINGLE SHAKER

SIZE Medium

MATERIALS Shaker: Aluminum
Jingles: Steel

FEATURE Two pairs of steel jingles are attached in one row to an octagonal aluminum shaker

COLOUR **BK**: Black

7 ALUMINUM SHAKER, ROUND

SIZE Large

MATERIAL Anodized aluminum

FEATURE Designed to cut through loud live music

COLOUR **S**: Silver

8 PROJECTION SHAKER

SIZE Large

MATERIAL Anodized aluminum

FEATURES For comfort and volume; Shimmering, cutting pitch; Exceptional for live playing

COLOUR **S**: Silver



10 CIRCULAR MOTION ENABLES A UNIQUE RATTLING



Spark shaker
SH16

11 SCREW-MOUNTED DISC ENABLES A TUNABLE PITCH



Spin spark
SH17

SENSATIONAL EFFECTS ARE PRODUCED WHEN COMBINED WITH ANOTHER SPARK SHAKER



12 HIGH PITCH & LOW PITCH



Clamshell spark, set of two
SH22

13



Headed spark
SH18

MOTION SHAKER (SEE PAGE 53)



MS-BK

14



Medium
SH20BK

BY COVERING AND UNCOVERING THE SOUND HOLE, A "WAH-WAH" EFFECT CAN BE ACHIEVED

15 LOUD AND PENETRATING SOUND DUE TO THE MANY HOLES



SH3BK

16



Black **SH21BK** Grey **SH21GR**

9 PROTON SHAKER
MATERIAL Aluminum
FEATURES Compact size; Easy to control; Made for precise playing techniques

10 ORIGINAL SPARK SHAKER
SIZE Medium
MATERIALS Shaker: Coated steel
 Pellets: Coated steel
FEATURES Circular motion enables a unique rattling; Spark Shakers may be played in pairs
FINISH Black nickel

11 SPIN SPARK SHAKER
SIZE Medium
MATERIALS Shaker: Coated steel
 Pellets: Coated steel
FEATURE Screw-mounted disc enables a tunable pitch
FINISH Black nickel

12 CLAMSHELL SPARK SHAKERS
MATERIAL Steel
FEATURES Comes in a set of two; Wildly variable pitch response
FINISH Black nickel

13 HEADED SPARK SHAKER
SIZE Medium
MATERIALS Shaker: Coated steel
 Pellets: Coated steel
 Goatskin head
FEATURES Premium goatskin and a steel shell provide a rattling combination; Swirling effect; Variable pitch
FINISH Black nickel

14 WAKAH SHAKER
SIZE Medium
MATERIALS Wooden body and synthetic chamber
FEATURE By covering and uncovering the sound hole, a "wah-wah" effect can be achieved
COLOUR **BK:** Black

15 LOOP SHAKER
SIZE Medium
MATERIAL Synthetic
FEATURE Loud and penetrating sound due to the many holes
COLOUR **BK:** Black

16 U.F.O. SHAKERS
SIZE Medium
MATERIAL Synthetic
COLOURS **BK:** Black
GR: Grey

WOOD SHAKERS, DOUBLE SHAKER, GANZA & CAXIXIS

1

Baltic Birch
SH50

Ovangkol
SH51

CUTTING SHAKER SOUND

2

Set, 3 pcs.
SH50-SET

DIFFERENT FILLINGS

3

EXOTIC ZEBRANO TOP AND BOTTOM

Small
SH53-S

Medium
SH53-M

4

Burl Wood
SH60

DUAL INTERNAL CHAMBERS

5

SOFT

Lime
SH56

6

Double Shaker
D01

Ganza
GA2

MEDIUM

Beech
SH58

LOUD

Oak
SH59

7

Small
CAX1

Medium
CAX2

Large
CAX3

1 MINI CAJON SHAKERS

SIZE 2" W x 2 3/4" H x 2" D

MATERIALS Resonating body: Baltic Birch (*Betula pendula*)
SH50
Frontplate: Baltic Birch (*Betula pendula*)
SH51

FEATURES Compact size; Cutting shaker sound; Miniature size of a MEINL cajon

2 MINI CAJON SHAKER SET

MATERIALS Resonating body: Baltic Birch (*Betula pendula*)
Frontplates: Exotic Zebrano, Burl Wood, Baltic Birch (*Betula pendula*)

FEATURES Three unique timbres for multiple sound options; Various frontplates for easy identification

3 WOOD SHAKERS, RECTANGLE

SIZES **S:** Small
M: Medium

MATERIALS Baltic Birch (*Betula pendula*)
Top and Bottom: Exotic Zebrano

FEATURES Wide sound options; Rectangle shaped

4 DUAL CHAMBER SHAKER

MATERIAL Baltic Birch Plywood (*Betula pendula*)
Top and Bottom: Burl Wood

FEATURES Dual internal chambers for greater shaker control; Easier to play consistent shaker patterns; Ultra-smooth sound

5 WOOD SHAKERS, ROUND

SIZE 4" length, 1 3/4" diameter

MATERIALS **SH56:** Lime
SH58: Beech
SH59: Oak

FEATURES Made from three wood species for different volume; Fits comfortably in your hand
SH56: Soft
SH58: Medium
SH59: Loud

6 DOUBLE SHAKER & GANZA

MATERIALS Rattan with coconut bottom

FEATURES **D01:** Offers two different sounds in one instrument
GA2: Crystal clear sound, high pitched with a great projection

7 CAXIXIS

SIZES **CAX1:** Small
CAX2: Medium
CAX3: Large

MATERIALS Rattan with coconut bottom

FEATURES Crystal clear sound, high pitched with a great projection; Woven by hand

MARACAS

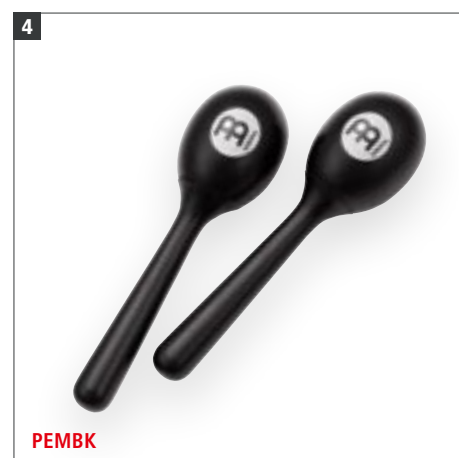
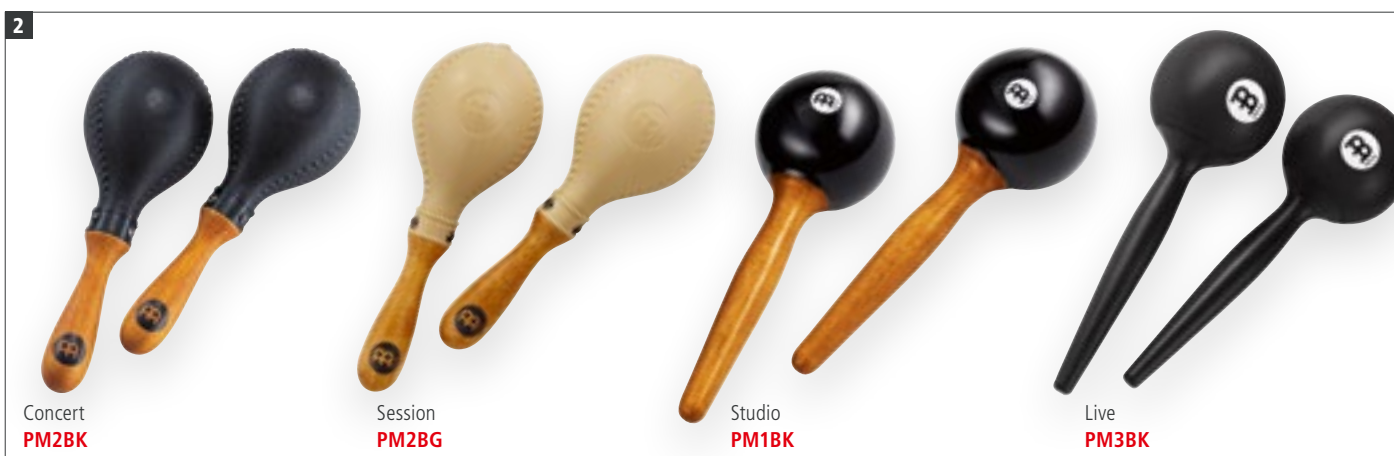
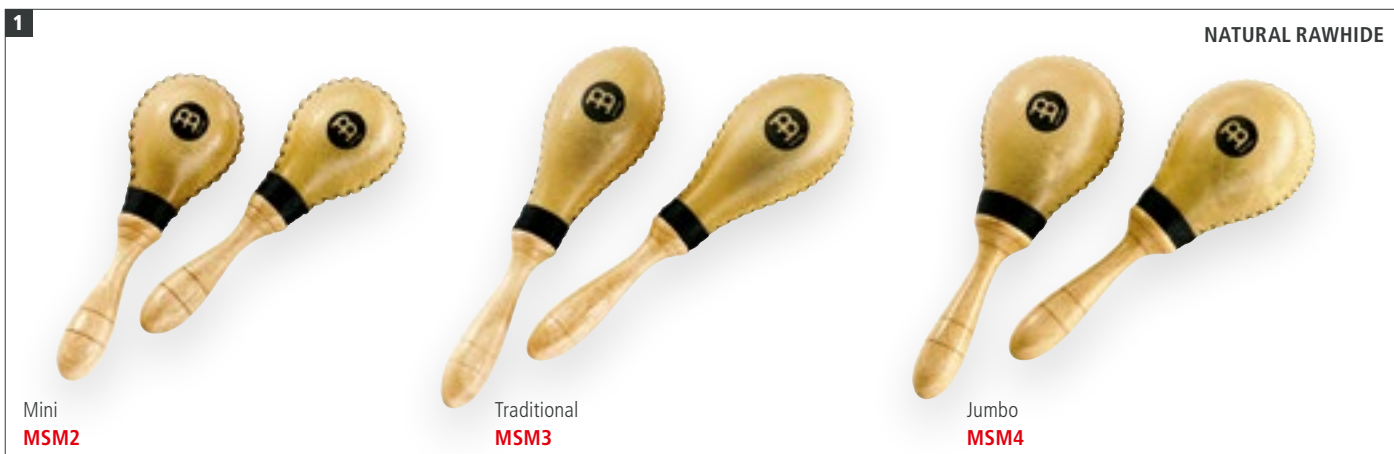

1 RAWHIDE MARACAS

SIZES **MSM2:** Mini
MSM3: Traditional
MSM4: Jumbo

MATERIALS Natural rawhide and wooden handle

FEATURES Entirely made by hand
Offers a wide sonic range
Durable construction

2 CONCERT, SESSION, STUDIO & LIVE MARACAS

MATERIAL Synthetic heads

FEATURE Ergonomically shaped handle

COLOURS **BG:** Beige
BK: Black

3 WOOD MARACAS

MATERIAL Wood

FEATURES Produces a traditional warm and rich sound
Available in both round and oval models

4 PLASTIC EGG MARACAS

SIZE 6"

MATERIAL Synthetic

FEATURE Ergonomically shaped handle



COWBELLS

1 BLACK POWDER COATED STEEL



8" **HCO2BK** 5" **HCO4BK**

2 BLACK POWDER COATED STEEL



8 1/2" **SL850-BK** 6 3/4" **SL675-BK** 5 1/4" **SL525-BK** 4 3/4" **SL475-BK**

3 EASY MOUNTABLE



2 1/2", 3 1/2", 5" **SLTRI-BK**

4 CLASSIC ROCK COWBELL TIMBALERO COWBELLS



7" big mouth, low pitch **SCL70B-BK** 8 1/2" low pitch **SCL850-BK** 7" high pitch **SCL70-BK**

HANDMATE
(SEE PAGE 95)



HAM1BK

5 HIGH POLISHED CHROME



8" big mouth **STB80B-CH** 8" small mouth **STB80S-CH** 7 1/2" **STB750-CH** 6 1/4" **STB625-CH** 5 1/2" **STB55-CH** 4 1/2" low pitch **STB45L-CH**

HAND BRUSHED STEEL



8" big mouth **STB80B** 8" small mouth **STB80S** 6 1/4" **STB625** 5 1/2" **STB55** 4 1/2" low pitch **STB45L** 4 1/2" medium pitch **STB45M** 4 1/2" high pitch **STB45H**

1 HEADLINER® SERIES COWBELLS

SIZES **HCO2BK:** 8" (Timbales Cowbell)
HCO4BK: 5" (Cha Cha Cowbell)

MATERIAL Special steel alloy

FEATURE Muffled sound

FINISH **BK:** Black powder coated

2 BLACK FINISH COWBELLS

SIZES **SL850-BK:** 8 1/2" (Timbales Cowbell)

SL675-BK: 6 3/4" (Medium Timbales Cowbell)

SL525-BK: 5 1/4" (Cha Cha Cowbell)

SL475-BK: 4 3/4" (Mini Cha Cha Cowbell)

MATERIAL Special steel alloy

FEATURE Muffled sound

FINISH **BK:** Black powder coated

3 TRIPLE BELL

SIZES 2 1/2", 3 1/2", 5"

MATERIAL Special steel alloy

FEATURE Muffled sound

FINISH **BK:** Black powder coated

4 STEEL CRAFT LINE COWBELLS

SIZES **SCL70B-BK:** 7" (Classic Rock Cowbell Big Mouth)

SCL850-BK: 8 1/2" (Timbalero Cowbell)

SCL70-BK: 7" (Timbalero Cowbell)

MATERIAL Special steel alloy

FEATURES Steel alloy controls overtones and resonance; Classic cowbell sound for any setting

FINISH **BK:** Black powder coated

5 CHROME & STEEL FINISH COWBELLS

SIZES **STB80B:** 8" (Timbales Cowbell Big Mouth)

STB80S: 8" (Timbales Cowbell Small Mouth)

STB750: 7 1/2" (Salsa Timbales Cowbell)

STB625: 6 1/4" (Medium Timbales Cowbell)

STB55: 5 1/2" (Cha Cha Cowbell)

STB45L: 4 1/2" (Low Cha Cha Cowbell)

STB45M: 4 1/2" (Medium Cha Cha Cowbell)

STB45H: 4 1/2" (High Cha Cha Cowbell)

MATERIAL Special steel alloy

FEATURE Tonally matched

FINISHES Hand brushed steel

CH: High polished chrome

6 HAMMERED COWBELLS

SIZES **STB80BHH:** 8" (Timbales Cowbell Big Mouth)

STB625HH: 6 1/4" (Medium Timbales Cowbell)

MATERIAL Special steel alloy

FEATURE Hammered



6 **HAND BRUSHED GOLD**  **8" big mouth** **STB80BHH-G** **6 1/4"** **STB625HH-G**

HAND BRUSHED STEEL  **8" big mouth** **STB80BHH-S** **6 1/4"** **STB625HH-S**

HAND BRUSHED COPPER  **8" big mouth** **STB80BHH-C** **6 1/4"** **STB625HH-C**

7  **DEMO VIDEO**

GROOVE BELL DESIGNED WITH MIKE JOHNSTON

7 3/4" **MJ-GB**

8  **BLACK POWDER COATED STEEL**

8" **BCOB**

9 **SPECIAL STEEL ALLOY** 

8 1/4" **STB815H** **7 3/4"** **STB785H** **6 1/2"** **STB65H**

10 **COMFORTABLE HOLDER** 

6 1/4" **STB625HA-CB** **4 1/2"** **STB45HA-CB**

11  **Magnetic Sustain Control** **MCT**

BASED ON BENNY GREB'S IDEA

12  **Drum Honey Slab** **MDHS**

13 **A DROP OF HONEY MAKES YOUR DRUMS AND CYMBALS SOUND SWEET** 

Drum Honey **MDH** **Drum Honey Assortment** **MDHA**

14 **NEW** 

Medium **MPCC-M** **Large** **MPCC-L**

FINISHES **C:** Hand brushed copper
G: Hand brushed gold
S: Hand brushed steel

7 ARTIST SERIES COWBELL MIKE JOHNSTON
SIZE 7 3/4"
MATERIAL Special steel alloy
FEATURES Specifically made for drum set use
INCLUDES Two magnets (one small and one large, based on Benny Greb's Magnetic Sustain Control idea)
FINISH Vintage Steel

8 BONGO COWBELL
SIZE 8" (Medium Handheld Cowbell)
MATERIAL Special steel alloy
FEATURES Muffled sound; For low volume playing
FINISH Black powder coated

9 HAND COWBELLS
SIZES **STB815H:** 8 1/4" (High Handheld Cowbell)
STB785H: 7 3/4" (Low Handheld Cowbell)
STB65H: 6 1/2" (Mini Handheld Cowbell)
MATERIAL Special steel alloy
FINISH Hand brushed steel

10 HANDHELD COWBELLS
SIZES **STB625HA-CB:** 6 1/4"
STB45HA-CB: 4 1/2"
MATERIAL Special steel alloy
FEATURE Comfortable holder
FINISH Hand brushed steel

11 MAGNETIC SUSTAIN CONTROL
CONTAINS 2 x Light dampening magnets (16 x 4 mm)
2 x Heavy dampening magnets (16 x 9 mm)
FEATURE Easily control the sustain and dampen the tone of your cymbals or cowbells
INCLUDES Storage container

12 DRUM HONEY SLAB
SIZE 3.54" x 2.36" x 0.31"
FEATURES Extra thick rectangular dampening gel pad; Creates a super meaty drum tone

13 DRUM HONEY
CONTAINS **MDH:** 1 pack of Drum Honey (6 pcs.)
MDHA: 12-piece Drum Honey Assortment (6 x small, 4 x medium, 2 x large)
FEATURES Transforms your drum sound into a warm and sweet tone with no effort; The gels can be removed and reused as needed; Washable and non-toxic

14 COWBELL CUSHIONS
SIZES **MPCC-M:** Medium (32 grams)
MPCC-L: Large (70 grams)
FEATURES Instantly turn your cowbell sound into a retro, super-dry effect; No adhesive material required

BLOCKS, TEMPLE BLOCK SETS & GÜIROS

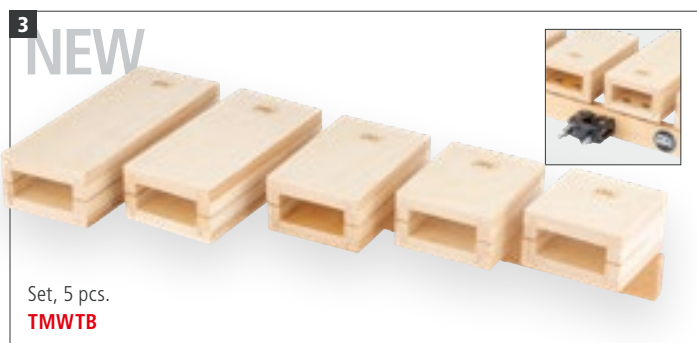

1 PERCUSSION BLOCKS

MATERIAL PE
FEATURES Ultra-durable plastic
MPE5NG: High pitched sound
MPE3BK: Medium pitched sound
MPE4R: Low pitched sound
INCLUDES Mounting Clamp
COLOURS **BK:** Black
NG: Neon Green
R: Red

2 SYNTHETIC TEMPLE BLOCK SET

MATERIAL PE
FEATURES 5-piece set of durable synthetic percussion blocks; Varying pitch from high (smallest block) to low (largest block); Hollow body design produces a rich percussion block tone; Metal frame with adjustable thumb screw mount

INCLUDES Mounting Clamp; Beater
COLOUR Black

3 WOOD TEMPLE BLOCK SET

MATERIAL Baltic Birch (*Betula pendula*)
FEATURES 5-piece tonally matched wood temple block set; 100% Baltic birch construction for natural wood tone; Rear mount fits any standard drum hardware; Tuning from low to high: D5, F5, A5, C6, D6
INCLUDES Two soft rubber head mallets

4 WOOD BLOCK HAND CLAP

MATERIAL Baltic Birch (*Betula pendula*)
FEATURES Combination wood block and hand clap effect; Baltic birch construction with steel cabasa chain; Padded surface to play with drumsticks

5 PROFESSIONAL WOOD BLOCKS

SIZES **M:** Medium
L: Large
MATERIALS Select Hardwood top
Siam Oak body (*Hevea brasiliensis* Muell.-Arg.)
FEATURES Well defined fundamental sound; Detailed with heat-branded logo
INCLUDES Wooden beater

6 WOOD BLOCKS

SIZES **MWB1BK:** Medium
MWB2BK: Large
MATERIAL Siam Oak (*Hevea brasiliensis* Muell.-Arg.)
FEATURE Rounded playing surface
INCLUDES Wooden beater
COLOUR **BK:** Black, matte

CASTANETS & CLAVES



HAND PERCUSSION

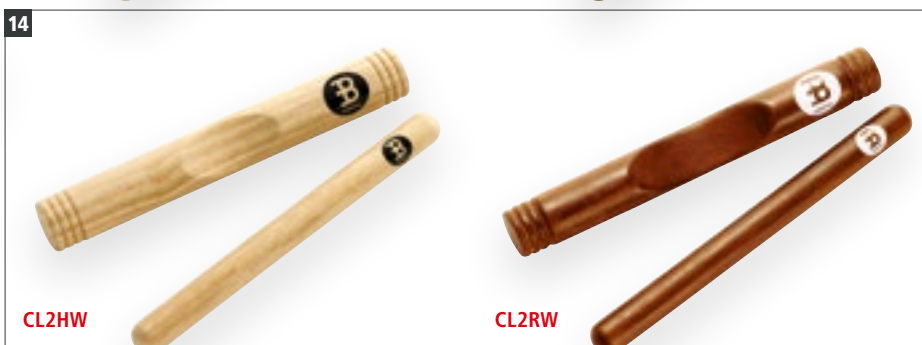

7 TURBO GÜIRO

MATERIAL High strength plastic
FEATURES Three striking surfaces; Rubber ringed grip holes
INCLUDES Synthetic scraper

8 FIBERGLASS GÜİROS

MATERIAL Premium fiberglass
FEATURES Three striking surfaces; Padded grip holes
INCLUDES **GU7BK**: Synthetic scraper
GU7BR: Wooden scraper
COLOURS **BK**: Black
BR: Brown

9 WOOD GÜİRO

MATERIAL Wood
FEATURE Grip holes
INCLUDES Wooden scraper
COLOUR **AM**: Amber

10 CASTANET MACHINE

SIZE 7 1/2" x 5"
MATERIAL Indian Rosewood
FEATURES Separately adjustable; Full and cutting resonance

11 TRADITIONAL HAND CASTANET

SIZE Traditional
MATERIAL Indian Rosewood
FEATURES Balanced handle; Precisely formed contours for clear, distinct sound

12 FINGER CASTANETS

SIZES **FC1**: Traditional
FC2: Concert
MATERIAL Indian Rosewood
FEATURE Full and cutting resonance

13 WOOD CLAVES, CLASSIC

MATERIALS **HW**: Hardwood
RW: Select Hardwood
FEATURE Solid body

14 WOOD CLAVES, AFRICAN

MATERIALS **HW**: Hardwood
RW: Select Hardwood
FEATURES **CL2**: Solid body
CL3: HOLLOWED OUT BODY

15 CLAVES DE LUXE

SIZE 6 3/4" long
MATERIAL Dense hardwood
FEATURES Cutting sound; Convenient carrying

CABASAS, SLEIGH BELLS & KALIMBAS

1 ADJUSTABLE NET FOR VARIOUS TENSIONS AND SOUND OPTIONS



CA7BR

2 PORTS FOR MORE VOLUME (PATENTED)



Large **CA5BK-L** Medium **CA5BK** Small **CA5BK-S** X-Small **PCA5BK-XS**

3 STEEL BELLS



36 bells **SLB36** 25 bells **SLB25** 12 bells **SLB12** 7 bells **SLB7**

4 PICKUP SYSTEM WITH VOLUME CONTROL



Medium **KA9P-AB**

5

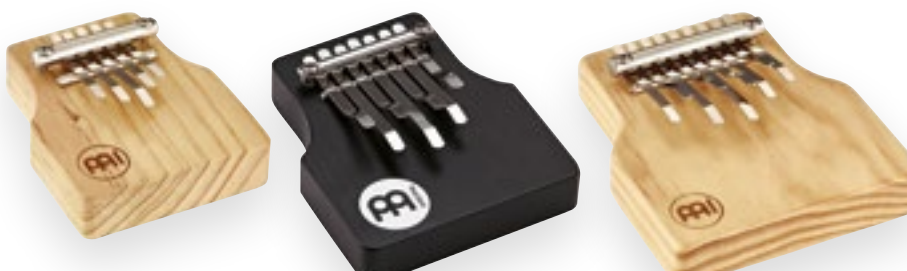

Small **KA5-S** Medium **KA7-M-BK** Medium **KA9-M**

6 WIDE OPENING FOR GREAT WAH-WAH EFFECTS



Medium **KA9WW-BK**

1 CABASA, FIBERGLASS

MATERIAL Premium fiberglass
FEATURES Adjustable net for various tensions and sound options
 Equals a traditional gourd calabash
COLOUR **BR:** Brown

2 TURBO CABASAS (PATENTED)

SIZES **PCA5BK-XS:** X-Small
CA5BK-S: Small
CA5BK: Medium
CA5BK-L: Large
MATERIALS Steel chain and stainless steel cylinder
CA: Wooden handle with padded soft grip
PCA: Synthetic grip
FEATURE 5 sound ports on each side for more volume (CN, US patent)
COLOUR **BK:** Black

3 SLEIGH BELLS

SIZES **SLB7:** 7 bells
SLB12: 12 bells
SLB25: 25 bells
SLB36: 36 bells
MATERIALS Steel bells
 Wooden handle
FEATURES Ergonomic grip
 True sleigh bell sound
SLB36: Double handle

4 PICKUP KALIMBA

SIZE Medium
MATERIALS Chrome plated steel
 Siam Oak (*Hevea brasiliensis* Muell.-Arg.)
TUNING a', c'', c', a', A, f', e', e'', b'
FEATURES Pickup system with external volume control
 Wah-wah effect
COLOUR **AB:** Antique Brown

5 SOLID KALIMBAS

SIZES **KA5-S:** Small
KA7-M-BK: Medium
KA9-M: Medium
MATERIALS Chrome plated steel
 New Zealand Pine (*Pinus radiata*)
TUNING **KA5-S:** g#'', c'', f', f'', c''''
KA7-M-BK: e', g, d'', e, c', a, a'
KA9-M: a', c'', c', a', A, f', e', e'', b'
FEATURES Ergonomic shape
KA5-S, KA9-M: Heat-branded logo
KA7-M-BK: Extra wide tongues

6 WAH-WAH KALIMBA

SIZE Medium
MATERIALS Chrome plated steel
 New Zealand Pine (*Pinus radiata*)
TUNING a', c'', c', a', A, f', e', e'', b'
FEATURE Wah-wah effect
COLOUR **BK:** Black

WHISTLE, GÜIRAS, ROCARS, SHAKERS & A-GO-GOS



HAND PERCUSSION

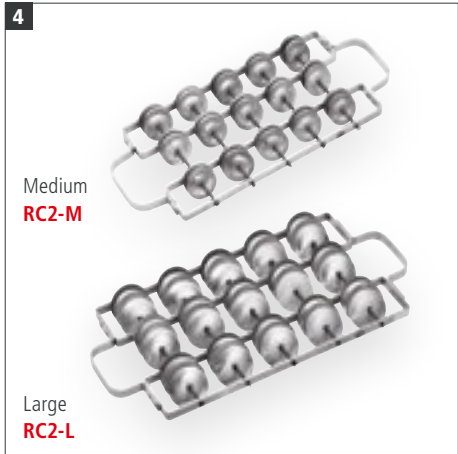

1 SAMBA WHISTLE
MATERIAL Aluminum
INCLUDES Neck lanyard

2 MERENGUE GÜIRAS
SIZES **MGU4**: X-Small; **MGU3**: Small; **MGU2**: Medium; **MGU1**: Large
MATERIAL Brushed steel
FEATURES Scraping surface with uniform raised bumps; One-piece metal grip with welded flanges
INCLUDES ABS scraper MGS2

3 MERENGUE GÜIRA SHAKER
MATERIAL Brushed steel
FEATURES Filling inside to produce a cutting shaker effect; Scraping surface with uniform raised bumps; One-piece metal grip with welded flanges
INCLUDES ABS scraper MGS2

4 ALUMINUM ROCARS
SIZES **RC2-M**: Medium; **RC2-L**: Large
MATERIAL Aluminum frame and jingles
FEATURES Light weight frame; Loud projection

5 ALUMINUM SAMBA SHAKERS
SIZES **S**: Small; **M**: Medium; **L**: Large
MATERIAL Aluminum
FEATURE Produces warm and cutting shaker sound

6 MODERN STYLE A-GO-GO STEEL FINISH MODELS
SIZES **STBAG1, STBAG5**: Small
STBAG2: Large
MATERIAL Special steel alloy
FEATURE Tonally matched
INCLUDES **STBAG1**: Mounting clamp
STBAG1, STBAG2: Hand brushed steel
STBAG5: Black powder coating

7 MODERN STYLE A-GO-GO CHROME FINISH MODELS
SIZES **STBAG4**: Small; **STBAG2**: Large
MATERIAL Special steel alloy
FEATURES Flexible connection; Bright sound
FINISH High polished chrome

8 TRADITIONAL STYLE A-GO-GO BELL
SIZE Medium
MATERIAL Special steel alloy
FEATURES Traditional shape; Flexible connection
FINISH High polished chrome

9 TRIPLE A-GO-GO BELL
SIZE Medium
MATERIAL Chrome plated steel
FEATURES Traditional Shape; Three tonally matched bells in equal intervals; Spring handle enables counterpoint rhythms

SOUND EFFECTS

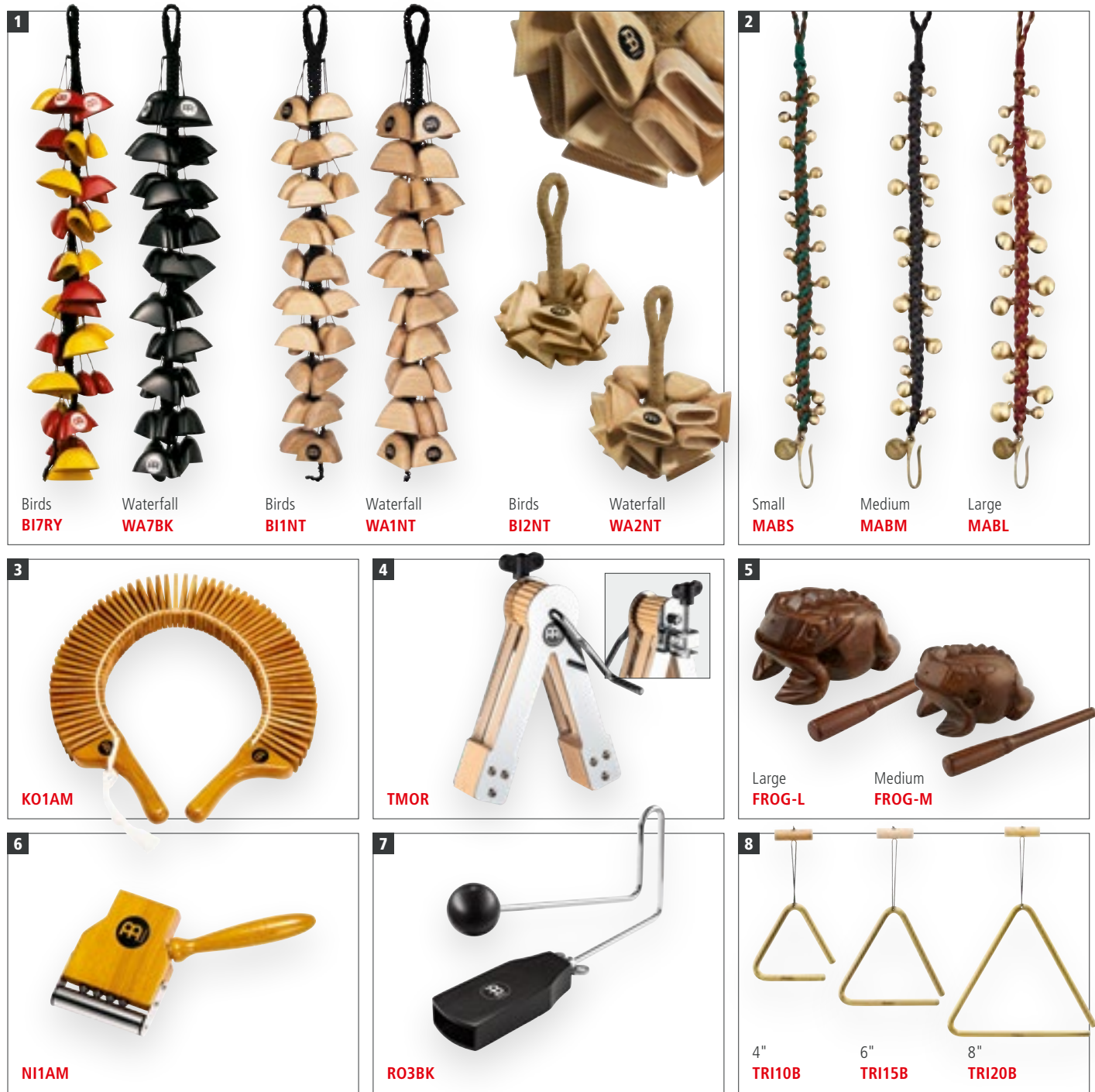

1 BIRDS & WATERFALLS

MATERIALS **B17RY, WA7BK:** Premium fiberglass
B11NT, WA1NT, B12NT, WA2NT: Siam Oak (*Hevea brasiliensis* Muell.-Arg.)

FEATURES Durable cord
BI: Realistically imitate the sound of a flock of birds; Bright sound with big dynamic range
WA: Realistically imitate the sound of a rippling waterfall

COLOURS **BK:** Black
NT: Natural
RY: Red/Yellow

2 AJUCH BELLS

SIZES 30" long
MABS: Small bells
MABM: Medium bells
MABL: Large bells

MATERIAL Brass and synthetic wax

FEATURES Cast bells; Solid hook for easy attachment; Synthetic wax rope

INCLUDES Canvas pouch for safe and simple storage

COLOURS **MABS:** Brown and Turquoise
MABM: Black
MABL: Dark Red and Gold

3 KOKIRIKO

MATERIAL Wood

FEATURES Ergonomically shaped handle; Durable cord

COLOUR **AM:** Amber

4 ORCHESTRA RATCHET

MATERIALS Chrome plated steel
Hood Pine Tines

FEATURES Produce quick notes like a cabasa or long-sustaining rattle effects; Wooden internal paddles project clearly; Easy to grip metal hand crank; Mountable on a stand

5 WOODEN FROGS

SIZES **M:** Medium; **L:** Large

FEATURE Authentic "ribbit" sound

6 THE NIGHT

MATERIALS Solid steel balls and cylinder
Wooden body

COLOUR **AM:** Amber

7 THE ROAR

MATERIAL Wood

FEATURE Rattling sustain

8 TRIANGLES

SIZES **TRI10B:** 4"
TRI15B: 6"
TRI20B: 8"

MATERIAL Solid brass

INCLUDES Wooden holder with braided nylon cord
Metal beater

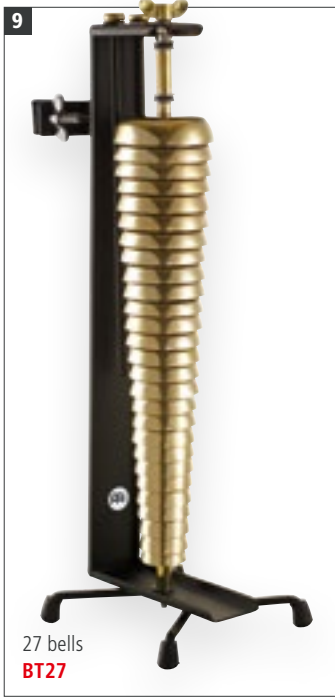

27 bells
BT27



14 bells
BT14



FICY-14

SPECIAL BRONZE ALLOY

SOUND EFFECTS



PFICY-2



FICY-2

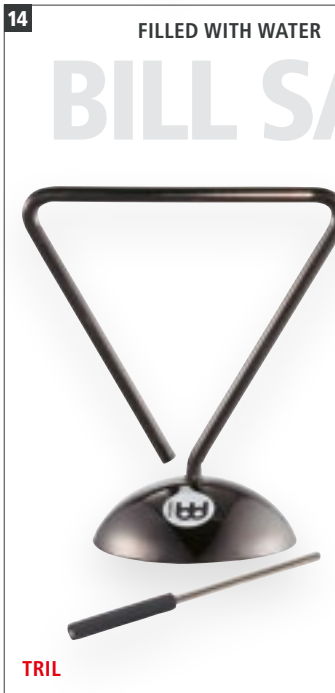

TRIL

FILLED WITH WATER

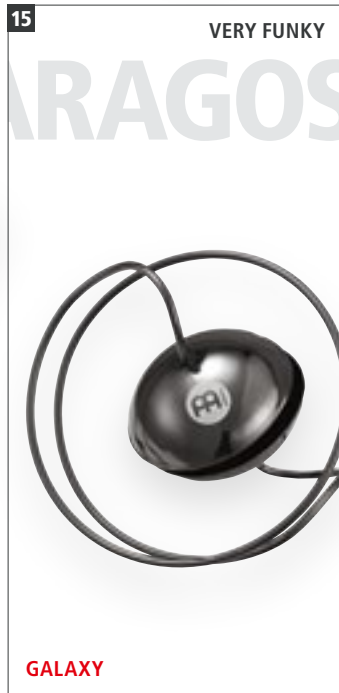

GALAXY

VERY FUNKY



BOWL

VERY LONG SUSTAIN



RB85

VERY LONG SUSTAIN



WW2BK

9 STAND ALONE BELL TREE

MATERIAL Solid brass bells
FEATURE Adjustable metal stand
INCLUDES Striker

10 HAND HELD BELL TREE

MATERIAL Solid brass bells
INCLUDES Striker

11 HANGING FINGER CYMBALS

SIZES 2 3/8" diameter
MATERIAL Special bronze alloy
FEATURES Shimmering sound; Durable cord

12 PROFESSIONAL FINGER CYMBALS

SIZE 2 5/8" diameter
MATERIAL Special bronze alloy
FEATURES Identical, high pitched sound; Durable cord

13 ORIENTAL FINGER CYMBALS

SIZE 2 3/8" diameter
MATERIAL Special bronze alloy

BILL SARAGOSA LINE 14 15 16

MATERIAL Special steel alloy
FEATURE Wide sound spectrum
FINISH Black nickel

14 LIQUID TRIANGLE

FEATURES Special steel alloy, filled with water
INCLUDES Metal beater

15 GALAXY

FEATURES Two resonant liquid chambers are connected by a long steel spiral liquid; Inside the two chambers exerts variable dampening on the steel resonator plates
INCLUDES Metal beater

16 HELIX BOWL

FEATURES Wonderful instrument consisting of a steel helix welded to a resonating chamber; Deep resonating wah-wah effect
INCLUDES Metal beater

17 RHYTHM BELL

SIZE 8 1/2"
MATERIAL Special cast alloy
FEATURES Cutting bell sound; Very long sustain

18 WAH-WAH TUBE

SIZE Large (low pitch)
MATERIAL Aluminum
INCLUDES Rubber mallet
COLOUR **BK:** Black

DIDGERIDOOS

1 COLOURFUL HAND-PAINTED ACCENTS HARKEN TO TRADITIONAL NATIVE AUSTRALIAN DESIGNS



47" **DDG1-BK** 47" **DDG1-BR** 47" **DDG1-R**

2



51" **SDDG1-BA** 51" **SDDG1-BK** S-Shape, 51" **SDDG2-BK**

3 TWO TELESCOPING SECTIONS



36"-62" **TSDDG1-BK**

1 WOOD DIDGERIDOOS

SIZE 47"
 MATERIAL Bamboo
 TUNING **DDG1-BK**: E
DDG1-BR: D#
DDG1-R: E
 COLOURS **BK**: Black
BR: Brown
R: Red

2 SYNTHETIC DIDGERIDOOS

SIZE 51"
 MATERIAL Lightweight synthetic
 TUNING **SDDG1-BA**: D
SDDG1-BK: D
SDDG2-BK: C#
 FEATURES **SDDG2-BK**
 "S" shaped body for bigger sounds
 Distinctive, full drone and harmonic overtones
 COLOURS **BA**: Bamboo
BK: Black

3 TROMBONE DIDGERIDOO

SIZE 36"-62"
 MATERIAL Premium fiberglass
 TUNING from: G#, G, F#, F, E, D#, D, C#, C
 FEATURE Two telescoping sections for variable pitch
 COLOUR **BK**: Black

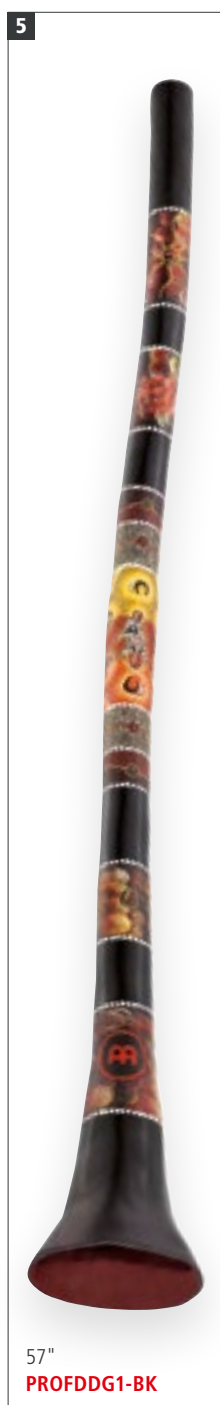

SMALL IN SIZE BUT BIG IN SOUND

DIDGERIDOOS

4 SYNTHETIC SLIDE TRAVEL DIDGERIDOO

SIZE Portable: 24"; Playable: 60"
MATERIAL Lightweight synthetic
TUNING D
FEATURES Contractible body for easy travel
 Distinctive, full drone and harmonic overtones
INCLUDES Bag
COLOUR **BK:** Black

5 PRO FIBERGLASS DIDGERIDOO

SIZE 57"
MATERIAL Premium fiberglass
TUNING D
COLOUR **BK:** Black

6 PRO SYNTHETIC DIDGERIDOO

SIZE 57"
MATERIAL Lightweight synthetic
TUNING D
COLOUR **BK:** Black

**7 ARTIST SERIES DIDGERIDOO
SIMON "SI" MULLUMBY**

SIZE 61"
MATERIAL Premium fiberglass
TUNING F
COLOUR Grey

8 TRAVEL DIDGERIDOO (US PATENT)

SIZE 8 1/2" x 5"
MATERIAL Mahogany Wood (*Swietenia macrophylla*)
TUNING C
FEATURES Heat-branded logo
 Compact size

9 DIDGERIDOO MOUTHPIECE

SIZE Inner diameter: 30 mm
 Outer diameter: 60 mm
MATERIAL Antiseptic beeswax
FEATURES Easy mountable
 100% pure beeswax
 Fits perfect on our didgeridoos

RAINSTICKS & RAINMAKER

1

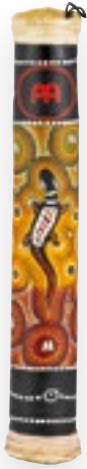

16"
RS1BK-S

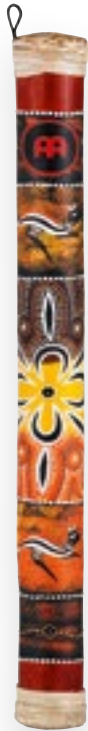

24"
RS1R-M

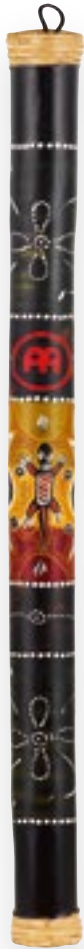

31 1/2"
RS1BK-M/L

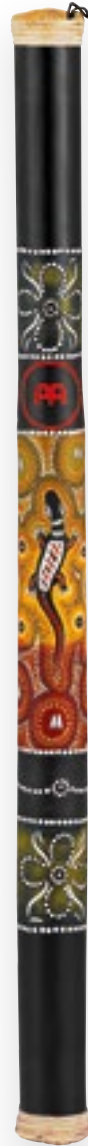

39"
RS1BK-L

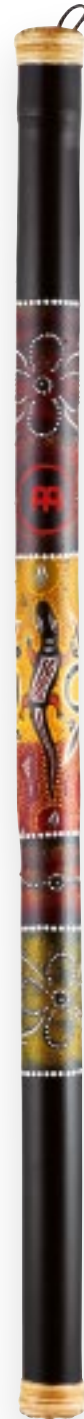

47"
RS1BK-XL



60"
RS1BK-XXL



1 WOOD RAINSTICKS

SIZES
S: 16"
M: 24"
M/L: 31 1/2"
L: 39"
XL: 47"
XXL: 60"
 MATERIAL Bamboo
 COLOURS **BK:** Black
R: Red

2 SYNTHETIC RAINSTICKS

SIZE **L:** 39"
 MATERIAL Lightweight synthetic
 COLOURS **BA:** Bamboo
R: Red

3 PRO RAINSTICK

SIZE **XL:** 47"
 MATERIAL Rattan wrapped Bamboo
 FEATURES Long susuration
 Authentic rain sounds

4 PRO RAINMAKER

SIZE 3 3/4" W x 25 1/4" H x 3 3/4" D
 MATERIAL Baltic Birch (*Betula pendula*)
 FEATURES Ultra long sustain
 Authentic rain sound
 Natural birch wood construction
 COLOUR **NT:** Natural



39"
SRS1BA-L

39"
SRS1R-L



47"
PRORS1-XL



ULTRA LONG SUSTAIN

RAINSTICKS & RAINMAKER



CHIMES

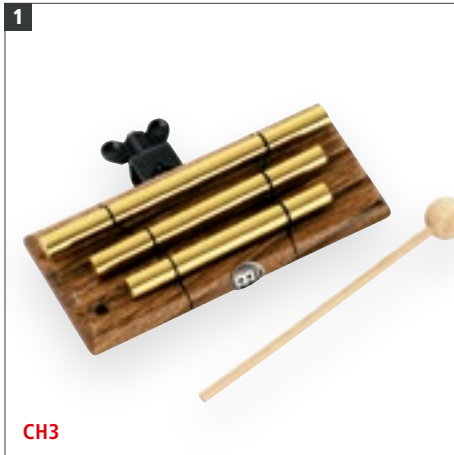

CH3



12 bars
CH-H12

18 bars
CH-H18

24 bars
CH-H24



12 pegs
CH-HPEG

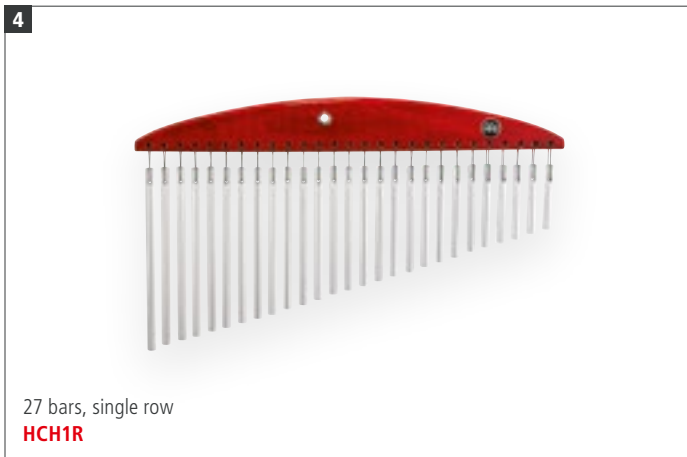

27 bars, single row
HCH1R



33 bars, single row
HCH2BK



27 bars, single row
CH27VWB



33 bars, single row
CH33VWB

1 TRI TONE CHIMES

- MATERIAL** Gold anodized aluminum alloy
- FEATURES** Three free-floating bars create a very long sustain
Tonally matched bars
Mountable on all common L-rods
- INCLUDES** Wooden beater and holder

2 HAND CHIMES

- SIZES** **CH-H12:** 12 bars
CH-H18: 18 bars
CH-H24: 24 bars
- MATERIAL** Gold anodized aluminum alloy
- FEATURES** Can easily be played by hand
Produce a full and rich sound

3 PEG CHIMES

- SIZE** 12 pegs
- MATERIAL** Gold plated steel
- FEATURE** Perfect for special accents

4 HEADLINER® SERIES CHIMES, 27 BARS

- SIZE** 27 bars, single row
- MATERIAL** Silver anodized aluminum alloy
- FEATURES** Great and affordable addition to any percussion set-up
Produce a full and warm chime sound
- COLOUR** **R:** Red

5 HEADLINER® SERIES CHIMES, 33 BARS

- SIZE** 33 bars, single row
- MATERIAL** Silver anodized aluminum alloy
- FEATURE** Generate a full sound spectrum
- COLOUR** **BK:** Black

6 VINTAGE CHIMES, 27 BARS

- SIZE** 27 bars, single row
- MATERIAL** Silver anodized aluminum alloy
- FEATURE** Excellent addition to any drum or percussion arrangement
- COLOUR** **VWB:** Vintage Wine Barrel

7 VINTAGE CHIMES, 33 BARS

- SIZE** 33 bars, single row
- MATERIAL** Silver anodized aluminum alloy
- FEATURES** Can be used in a wide range of musical styles
Producing a sweet sparkling sound
- INCLUDES** Holder; Striker
- COLOUR** **VWB:** Vintage Wine Barrel

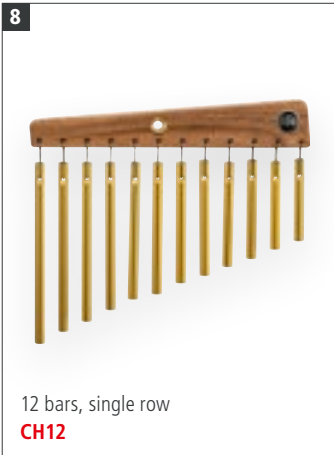

12 bars, single row
CH12

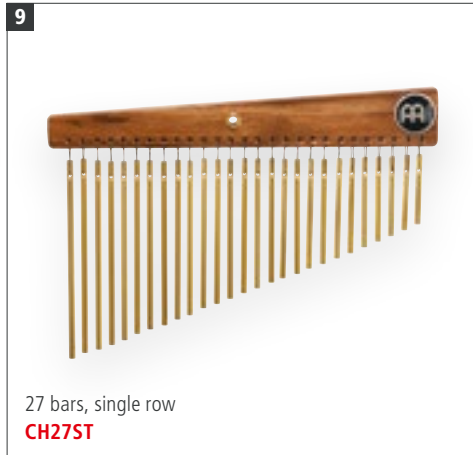

27 bars, single row
CH27ST



27 bars, single row
CH27

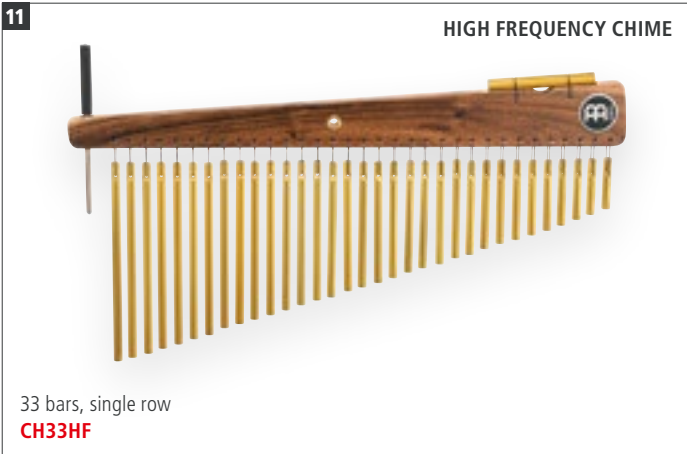

33 bars, single row
CH33HF



66 bars, double row
CH66HF

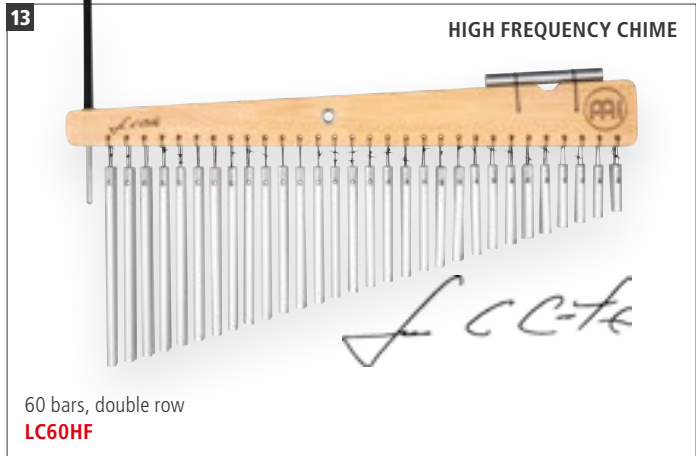

60 bars, double row
LC60HF



LUIS CONTE

8 CHIMES, 12 BARS

SIZE 12 bars, single row
MATERIAL Gold anodized aluminum alloy
FEATURES Produce a beautiful, high pitched sound
Ideal for tasteful chime accents

9 STUDIO CHIMES, 27 BARS

SIZE 27 bars, single row
MATERIAL Gold anodized aluminum alloy
FEATURE Slightly thinner bars for a full, rich and delicate sound

10 CHIMES, 27 BARS

SIZE 27 bars, single row
MATERIAL Gold anodized aluminum alloy
FEATURES Produce a full sound with a wide tonal spectrum
Ideal for smaller stages and club scenes

11 CHIMES, 33 BARS

SIZE 33 bars, single row
MATERIAL Gold anodized aluminum alloy
FEATURES Produce a very bright sound with a pronounced upper overtone spectrum
Perfect for all live situations
High frequency chime
INCLUDES Holder; Striker

12 CHIMES, 66 BARS

SIZE 66 bars, double row
MATERIAL Gold anodized aluminum alloy
FEATURES Produces a rich and full sound
Cut through any band setting
High frequency chime
INCLUDES Holder; Striker

13 ARTIST SERIES CHIMES LUIS CONTE

SIZE 60 bars, double row
MATERIAL Silver anodized aluminum alloy
FEATURES Produces a bright sound from the medium and low pitched bars
Perfect for all studio situations
High frequency chime
INCLUDES Holder; Striker

PERCUSSION STOMP BOXES

1 NEW



Kick
STB1



Cowbell
STB2



Clap
STB3



Tambourine
STB4



HiHat
STB5

2 CREATES A FOOT STOMPING ANALOG SIGNAL



Analog
MPS1



MPSM



4 REAL BASS DRUM FEEL IN A PORTABLE PACKAGE



Set, 4 pcs.
MPS1-SET

1 PERCUSSION STOMP BOXES

MATERIAL Aluminum

FEATURES Create hands-free beats by tapping your foot; Pre-programmed percussion sound effect; Perfect for cajon players, guitarists and multi-instrumentalists; High-quality 1/4" output jack

SOUNDS **STB1:** Kick

STB2: Cowbell

STB3: Clap

STB4: Tambourine

STB5: HiHat

2 PERCUSSION STOMP BOX, ANALOG

MATERIAL Solid Mahogany body

FEATURES Perfect for percussionists and multi-instrumentalists; 1/4" input and output jacks; Creates a foot stomping analog signal; Built-in Piezo pickups with volume control

INCLUDES L-shaped soft foam beater

3 STOMP BOX MOUNT

MATERIAL Baltic Birch (*Betula pendula*)

FEATURES Play your MEINL Stomp Box with the feel of a bass drum; Attach any common bass drum pedal; Works with all MEINL Stomp Boxes; Baltic birch construction; Use the MEINL L-Shaped beater to get flush contact (model BBB2 – sold separately)

FINISH Black

4 STOMP BOX SET

CONTAINS 1 x Analog Stomp Box (MPS1)

1 x Stomp Box Mount (MPSM)

1 x Bassbox/Snarebox Pedal (TMBP)

1 x L-shaped soft foam beater (BBB2)

FEATURES Real bass drum feel in a portable package; Perfect for soloists, percussionists and musicians on the move; Easy connectivity with 1/4" input and output jacks

5 BASSBOX & PICKUP BASSBOX

SIZE 17 1/2" W x 6 3/4" H x 11 3/4" D

MATERIAL Resonating body: Baltic Birch (*Betula pendula*)

FEATURES Perfect for guitarists and singers; Immense bass sound

PBASSBOX

Piezo pickup with high quality output jack

INCLUDES L-shaped soft foam beater

COLOUR Black

FINISH Matte

6 SNAREBOX & PICKUP SNAREBOX

SIZE 7 1/2" W x 7 1/2" H x 13" D

MATERIAL Baltic Birch (*Betula pendula*)

FEATURES Perfect for guitarists and singers; Crisp snare sound

PSNAREBOX

Piezo pickup with high quality output jack

INCLUDES L-shaped felt beater

BASSBOXES, SNAREBOXES & EFFECTS PEDAL



FOOT PERCUSSION

5 ALUMINUM RAIL TO MOUNT ANY COMMON FOOT PEDAL



Bassbox
BASSBOX

IMMENSE BASS SOUND



Pickup Bassbox
PBASSBOX

L-SHAPED SOFT FOAM BEATER INCLUDED

6 TWO INTERNAL SNARE WIRES



Snarebox
SNAREBOX

CRISP SNARE SOUND



Pickup Snarebox
PSNAREBOX

L-SHAPED FELT BEATER INCLUDED

7



Soft foam
BBB2

8



Felt
SBB1

9



Brass jingles
BBB1

10



Foam rubber
BBB3

11



Artificial fur
BBB4

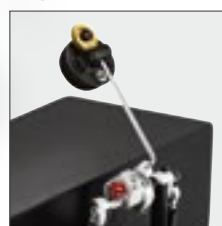

12 PERFECT FOR THE MEINL BASSBOX AND SNAREBOX



TMBP

13 A WHOLE PERCUSSION KIT IN A BOX



FX20

COLOUR Black
FINISH Matte

7 BASSBOX BEATER
MATERIAL Soft foam rubber
FEATURE Punchy response

8 SNAREBOX BEATER
MATERIAL Felt
FEATURE Crisp snare response

9 JINGLE CONTACT BASSBOX/SNAREBOX BEATER
MATERIALS Soft foam rubber
Brass jingles
FEATURE Soft L-shaped foam rubber beater with adjustable brass jingles

10 HAMMER HEAD BASSBOX/SNAREBOX BEATER
MATERIAL Foam rubber
FEATURES Hammer Head shape for a pronounced kick sound; Dual playing surfaces for boom or punch; Draws out a naturally deep tone

11 WOOLLY MAMMOTH BASSBOX/SNAREBOX BEATER
MATERIAL Artificial fur
Soft foam
FEATURES Woolly Mammoth beater produces a soft kick sound; Delivers a mellow attack for low volume and texture

12 BASSBOX/SNAREBOX PEDAL
MATERIAL Steel
FEATURE Adjustable spring tension to dial in your comfort zone

13 EFFECTS PEDAL
MATERIALS ABS
Steel
FEATURES Ideal for multi-instrumentalists and percussionists; Ten pre-programmed percussion samples and ten custom samples; Weighted body for a sturdy feel; Highly dynamic pedal with smooth spring back and no sound interference
INCLUDES Micro SD card and power supply with international adapters
SOUNDS 0 - Kick Bass; 1 - Soft Kick; 2 - 808 Bass; 3 - 808 Snare; 4 - HiHat; 5 - Clave; 6 - Hand Clap; 7 - Cowbell; 8 - Straight Tambourine; 9 - Shaker

FOOT PERCUSSION

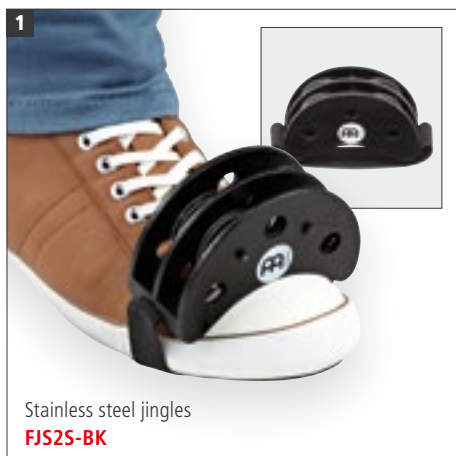

Stainless steel jingles
FJS2S-BK



Stainless steel jingles
CFJS2S-BK



Stainless steel jingles
CFT5-BK



Synthetic
FS-BK



Siam Oak, Synthetic
CFC-BK

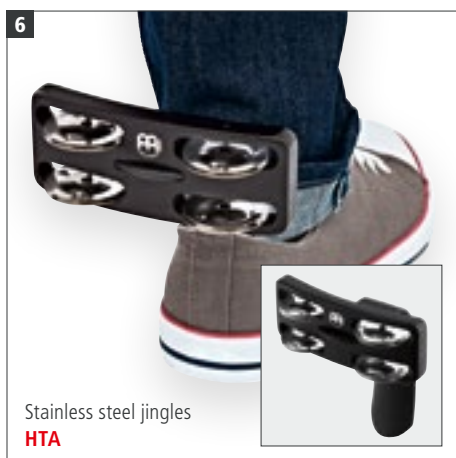

Stainless steel jingles
HTA



Stainless steel jingles
PHTA



Synthetic
HSH

1 FOOT TAMBOURINE

MATERIALS Siam Oak (*Hevea brasiliensis* Muell.-Arg.)
Stainless steel jingles
FEATURE Hassle-free mounting

2 COMPACT FOOT TAMBOURINE

MATERIALS Synthetic
Stainless steel jingles
FEATURE Attaches quickly and easily to foot via elastic strap

3 CAJON FOOT TAMBOURINE

MATERIALS Siam Oak (*Hevea brasiliensis* Muell.-Arg.)
Stainless steel jingles
FEATURES 5 pairs of stainless steel jingles
Easily mountable

4 FOOT SHAKER

MATERIAL Synthetic
FEATURES Easy mountable
Shaker mounted at a special angle for precise control

5 CAJON FOOT CASTANET

MATERIALS Siam Oak (*Hevea brasiliensis* Muell.-Arg.)
Synthetic
FEATURES Traditional castanet sound
Easily mountable
Pair of synthetic castanets

6 HEEL TAMBOURINE

MATERIALS Siam Oak (*Hevea brasiliensis* Muell.-Arg.)
Synthetic
Stainless steel jingles
FEATURES Stainless steel jingles for a bright full sound
Shoehorn design fits comfortably against your heel
Great accessory for hands free playing

7 PROFESSIONAL HEEL TAMBOURINE

MATERIALS Siam Oak (*Hevea brasiliensis* Muell.-Arg.)
Synthetic
Stainless steel jingles
FEATURES Stainless steel jingles for a bright, full sound
Adjustable mounting system fits perfectly against your heel
Great accessory for hands-free playing

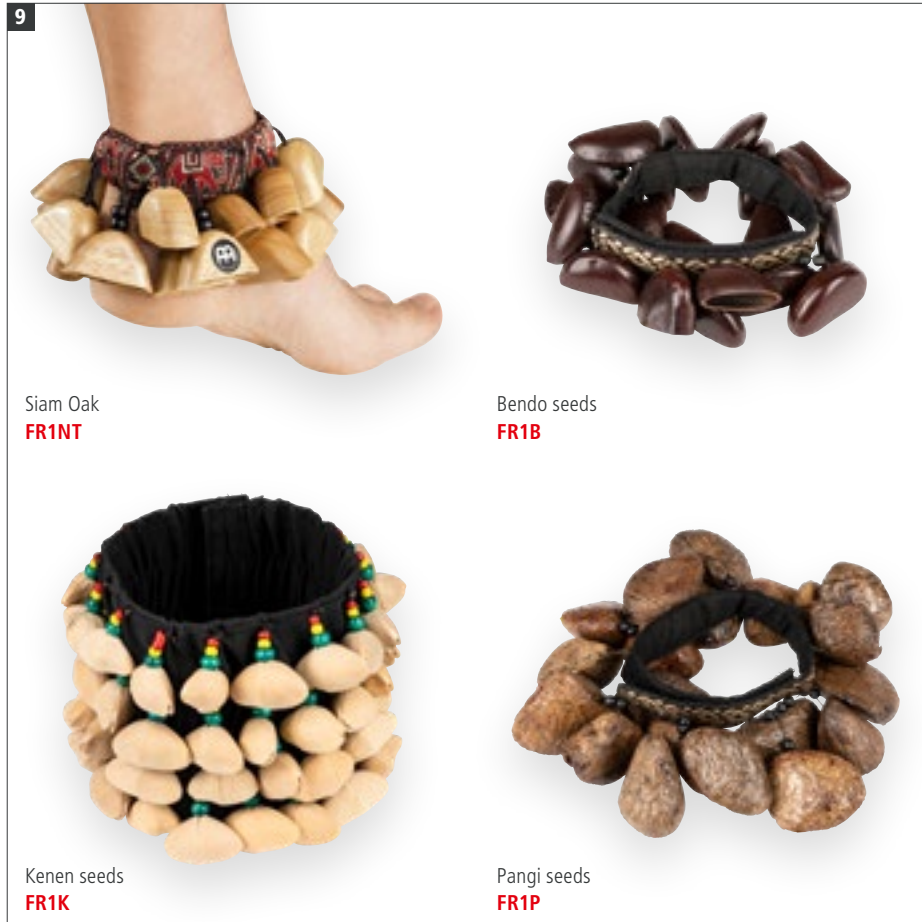

8 HEEL SHAKER
MATERIAL Synthetic
FEATURES Great accessory for hands-free playing
 Shoehorn design fits comfortably against your heel

9 FOOT RATTLES
MATERIALS **FR1NT:** Siam Oak (Hevea brasiliensis Muell.-Arg.)
FR1B: Bendo seed nutshells
FR1K: Kenen seed nutshells
FR1P: Pangi seed nutshells
FEATURES Hands-free – straps securely and comfortably around your ankle
 Creates a hollow wooden shaker effect with warmth and depth
 Equipped with hook-and-loop strap for a universally adjustable fit

10 FOOT CABASA (PATENTED)
SIZE Large
MATERIALS Steel chain and stainless steel cylinder
 Wooden body
 Black powder coated pedal
FEATURES Optional single or double-stroke setting
 5 sound ports on each side for more volume
INCLUDES Drum key
 Foot pedal

11 TAMBOURINE HOLDER SET
MATERIAL Baltic Birch (*Betula pendula*)
CONTAINS Tambourine Holder
 Headliner® Series Hand Held ABS
 Tambourine (HTBK)
FEATURE Perfect for cajon players, guitarists and singers

ARTISAN EDITION CAJONS

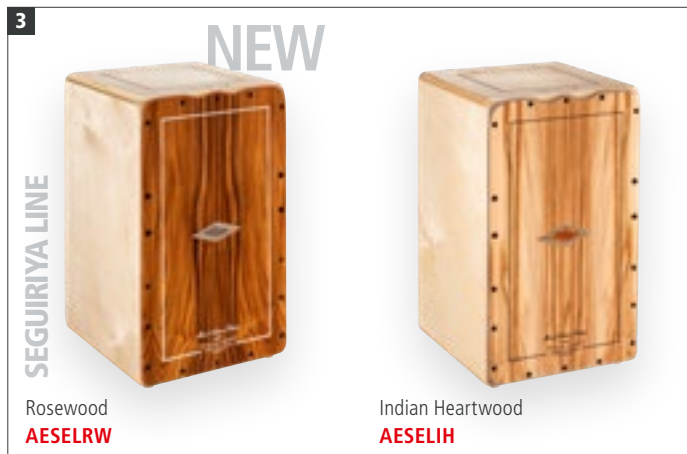

José Hernández Díaz also known as 'Pepote' – was born in Huelva (Spain) in November 1976. He inherited his passion for wood from his father and grandfather, both of whom were aficionados of woodworking and model aeroplanes.

He first came across the Cajon at the age of 13 while watching a Paco de Lucia concert on television. Inspired to make his own, he soon started receiving commissions from friends and acquaintances when they realised that the Cajon was virtually impossible to get hold of in Spain. Pepote began taking these instruments to local shops in his city when he was just 15 years old. This marked the start of his woodworking training, where he focused on the production of musical instruments by studying techniques for making ancient musical instruments and guitars while also completing his studies in industrial furniture design.



Since then, he has been continually developing the instrument and relentlessly perfecting his craft. He came up with an aesthetic based on comfort, tried and tested more than 30 different kinds of wood for construction, created a special unbreakable string for the Cajon and tried 20 different kinds of varnish for the finish. The list goes on. Everything he does revolves around getting the best possible sound out of the instrument and providing the ultimate peace of mind for the percussionist.



ARTISAN EDITION CAJONS

FEATURES Rounded corners and thumb notches for optimal playing comfort and sound
Ergonomically rounded frontplate with convex contact
Specially formulated soft rubber feet
Martinete, Fandango, Seguriya, Cantina Line:
Extra thick wooden sound port ring for compression
Two tuning screws to adjust the tension for each set of strings
Pop filter on soundhole
Seguriya, Cantina, Minera, Bulería, Soleá, Tango Line:
Elegant heat-branding on resonating body

1 MARTINETE LINE

SIZE 11 1/2" W x 19" H x 12 3/4" D
MATERIALS Resonating body: Solid Wood (15 mm)
Tulip Poplar (*Liriodendron tulipifera*)
Frontplate: Brazilian Ironwood (*Phoebe porosa*) with Ukola Woodframe
FEATURES Two sets of 10 adjustable strings (Separately per side)
6 specially formulated soft rubber feet
INCLUDES Tuning key

2 FANDANGO LINE

SIZE 11 1/2" W x 19" H x 12" D
MATERIALS Resonating body: Solid Wood (15 mm)
Tulip Poplar (*Liriodendron tulipifera*)
Frontplate: Indian Heartwood
FEATURES Two sets of 8 adjustable strings (Separately per side)
6 specially formulated soft rubber feet
INCLUDES Tuning key

3 SEGURIYA LINE

SIZE 11 1/4" W x 19" H x 11 3/4" D
MATERIALS Resonating body: 9-Ply (12 mm)
Baltic Birch (*Betula Pendula*)
AESELIH Frontplate: Indian Heartwood
AESELRW Frontplate: Rosewood
FEATURE Two sets of 8 adjustable strings (Separately per side)
INCLUDES Tuning key

4 CANTINA LINE

SIZE **AECLBE, AECLLI** 11 1/4" W x 19" H x 11 3/4" D
AECLWN 12 1/2" W x 18 1/2" H x 12 1/2" D
MATERIALS Resonating body: 9-Ply (12 mm)
Baltic Birch (*Betula Pendula*)
AECLBE Frontplate: Brown Eucalyptus
AECLLI Frontplate: Limba
AECLWN Frontplate: Walnut

6 **NEW** **BASS REFLEX SYSTEM**

BULERÍA LINE

Tulip
AEBLTL

Mongoy
AEBLMY

7 **BASS REFLEX SYSTEM**

SOLEÁ LINE

Ebony Burst
AESLEYB

Dark Red Burst
AESLRB

8 **NEW** **NEW** **NEW**

TANGO LINE

Blue Fade
AETLBF

Red Fade
AETLRF

Satin Black
AETLSBK

Espresso Burst
AESLEB

Brown Eucalyptus
AETLBE

Grey Eucalyptus
AETLGE

Light Eucalyptus
AETLLE

Limba
AETLLI

FEATURES **AECLBE, AECLLI**
Forward projecting sound port;
Two sets of 6 pre-tuned strings
AECLWN
Two sets of 8 adjustable strings from the top (Separately per side);
Decorative wood inlay

INCLUDES Tuning key

5 MINERA LINE

SIZE 11 1/4" W x 19" H x 11 3/4" D

MATERIALS Resonating body: 9-Ply (12 mm)
Baltic Birch (*Betula Pendula*)
AEMILLI Frontplate: Limba
AEMILBE Frontplate: Brown Eucalyptus

FEATURE Two sets of 4 adjustable strings (Separately per side)

INCLUDES Tuning key

6 BULERÍA LINE

SIZE 11 1/4" W x 19" H x 11 3/4" D

MATERIALS Resonating body: 9-Ply (12 mm)
Baltic Birch (*Betula Pendula*)
AEBLMY Frontplate: Mongoy
AEBLTL Frontplate: Tulip

FEATURES Two sets of 5 adjustable strings (Separately per side)
Tuning screw to adjust string tension
Pop filter on soundhole
Bass reflex system

INCLUDES Tuning key

7 SOLEÁ LINE

SIZE 11 1/4" W x 19" H x 11 3/4" D

MATERIALS Resonating body: 9-Ply (12 mm)
Baltic Birch (*Betula Pendula*)
Frontplate: Selected wood

FEATURES Two sets of 4 pre-tuned strings
Bass reflex system

FINISHES **AESLEB** Frontplate: Espresso Burst
AESLEYB Frontplate: Ebony Burst
AESLRB Frontplate: Dark Red Burst

8 TANGO LINE

SIZE 11 1/4" W x 19" H x 11 3/4" D

MATERIALS Resonating body: 7-Ply (9 mm)
Baltic Birch (*Betula Pendula*)
AETLBE Frontplate: Brown Eucalyptus
AETLBF Frontplate: Selected wood
AETLGE Frontplate: Grey Eucalyptus
AETLLE Frontplate: Light Eucalyptus
AETLLI Frontplate: Limba
AETLRF Frontplate: Selected wood
AETLSBK Frontplate: Selected wood

FEATURE Two sets of 3 pre-tuned strings

FINISHES **AETLBF** Frontplate: Blue Fade
AETLRF Frontplate: Red Fade
AETLSBK Frontplate: Satin Black

WOODCRAFT & HEADLINER® SERIES CAJONS

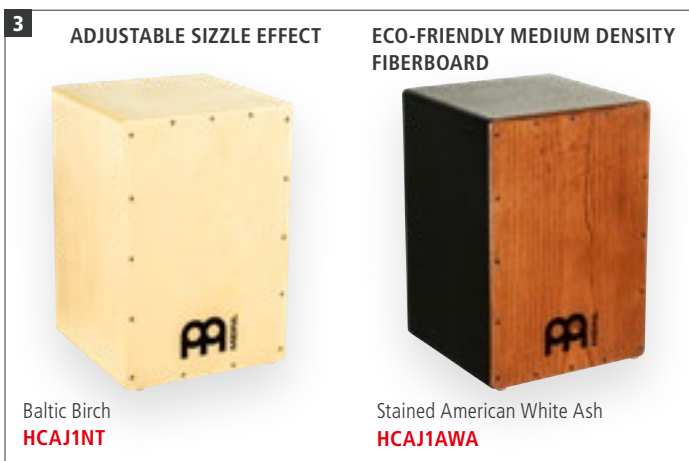
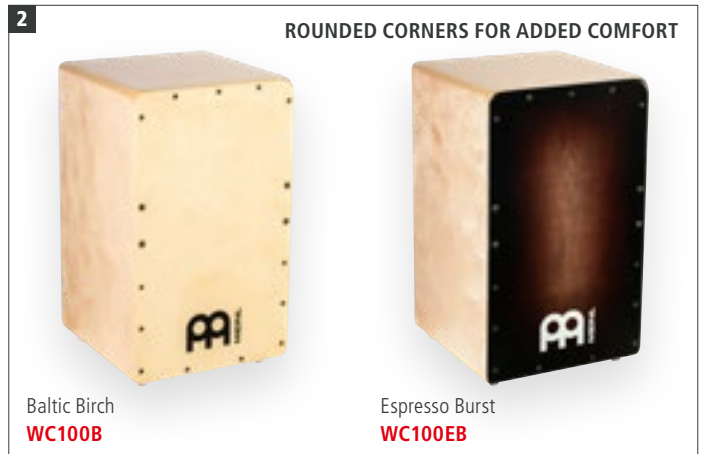

WOODCRAFT CAJONS **1** **2**

SIZE 11 3/4" W x 19 3/4" H x 12" D
FEATURES Custom micro-coiled steel cajon strings
 Baltic birch construction
 Rounded corners for added comfort
 Rubber feet and rear sound port

1 WOODCRAFT PROFESSIONAL CAJONS

MATERIALS Resonating body: 9-Ply (12 mm)
 Baltic Birch (*Betula pendula*)
WCP100MB Frontplate: Makah-Burl
WCP100MH Frontplate: Mahogany

2 WOODCRAFT CAJONS

MATERIALS Resonating body: 7-Ply (9 mm)
 Baltic Birch (*Betula pendula*)
WC100B Frontplate: Baltic Birch (*Betula pendula*)
WC100EB Frontplate: Espresso Burst

3 HEADLINER® SERIES STRING CAJONS

SIZE 11 3/4" W x 18" H x 12 1/4" D
MATERIALS **HCAJ1AWA**
 Resonating body: Eco-friendly medium density fiberboard
 Frontplate: Stained American White Ash (*Fraxinus Americana* L.)
HCAJ1NT

Resonating body: Baltic Birch (*Betula pendula*)
 Frontplate: Baltic Birch (*Betula pendula*)
FEATURES Adjustable top corners
 Adjustable sizzle effect
 Anti-slip sitting surface
 Wide sound options

INCLUDES Hex key
FINISH Matte

4 HEADLINER® SERIES SNARE CAJON

SIZE 11 3/4" W x 18" H x 11 3/4" D
MATERIALS Resonating body: Eco-friendly medium density fiberboard
MA Frontplate: Maple
CBF, LPF, PBF, SAF, TRF Frontplate: American White Ash (*Fraxinus Americana* L.)

FEATURES Dual internal fixed snare wires
 Adjustable top corner
 Wide sound options

FINISHES Matte
CBF Frontplate: Charcoal Black Fade
LPF Frontplate: Lilac Purple Fade
MA Frontplate: Natural
PBF Frontplate: Pacific Blue Fade
SAF Frontplate: Sonoran Amber Fade
TRF Frontplate: Tango Red Fade

SNARECRAFT & JAM CAJONS



5 FOOT ACTIVATED SNARE SWITCH SNARE SWITCH KNOB

American White Ash Walnut
SCP100AWA **SCP100WN**

6

Almond Birch Almond Birch Baltic Birch Baltic Birch
SC80AB **SC100AB** **SC80AB-B** **SC100AB-B**

Baltic Birch Baltic Birch Burl Wood Burl Wood Heart Ash Heart Ash
SC80B **SC100B** **SC80BW** **SC100BW** **SC80HA** **SC100HA**

7

Almond Birch Baltic Birch Baltic Birch Burl Wood Heart Ash
JC50AB **JC50AB-B** **JC50B** **JC50BW** **JC50HA**

5 SNARECRAFT PROFESSIONAL CAJONS
SIZE 11 3/4" W x 19 3/4" H x 12" D
MATERIALS Resonating body: 9-Ply (12 mm)
 Baltic Birch (*Betula pendula*)
SCP100AWA
 Frontplate: American White Ash (*Fraxinus Americana* L.)
SCP100WN
 Frontplate: Walnut
FEATURES Adjustable snare for both Flamenco and Peruvian styles
 Baltic birch construction
 Rounded corners for added comfort
 Rubber feet and rear sound port
SCP100AWA
 Equipped with a foot activated snare switch
SCP100WN
 Equipped with a snare switch knob on the side of the cajon

SNARECRAFT & JAM CAJONS 6 7
MATERIALS **SC80AB, SC100AB, JC50AB**
 Resonating body: 7-Ply (9 mm)
 Baltic Birch (*Betula pendula*)
 Frontplate: Almond Birch (*Betula pendula*)
SC80AB-B, SC100AB-B, JC50AB-B
 Resonating body: 7-Ply (9 mm)
 Almond Birch (*Betula pendula*)
 Frontplate: Baltic Birch (*Betula pendula*)
SC80B, SC100B, JC50B
 Resonating body: 7-Ply (9 mm)
 Baltic Birch (*Betula pendula*)
 Frontplate: Baltic Birch (*Betula pendula*)
SC80BW, SC100BW, JC50BW
 Resonating body: 7-Ply (9 mm)
 Baltic Birch (*Betula pendula*)
 Frontplate: Burl Wood

SC80HA, SC100HA, JC50HA
 Resonating body: 7-Ply (9 mm)
 Baltic Birch (*Betula pendula*)
 Frontplate: Heart Ash

6 SNARECRAFT CAJONS
SIZES **SC80:** 11 3/4" W x 18" H x 11 3/4" D
SC100: 11 3/4" W x 19 3/4" H x 11 3/4" D
FEATURES Dual internal fixed snare wires
 Baltic birch construction
 Rounded corners for added comfort
 Rubber feet and rear sound port

7 JAM CAJONS
SIZE 10 1/2" W x 15" H x 10 1/4" D
FEATURES Compact size
 Baltic birch construction
 Dual internal fixed snare wires
 Rubber feet and rear sound port

SLAPTOP, SWIVEL, TRAVEL & BONGO CAJONS

1

VIDALITA LINE



Palo Santo, satin
AEVLP5

2

COMFORTABLE DESIGN FOR A MORE UPRIGHT PLAYING STYLE (PATENTED)



Makah-Burl, matte
TOPCAJ1MB

Espresso Burst, matte
TOPCAJ1EB

3

CONTRASTING PLAYING SURFACES ON OPPOSITE SIDES



Baltic Birch, matte
HOPCAJ3NT

THE TURBO SLAPTOP CAJONS ARE BIGGER FOR MORE VOLUME



Walnut, matte
TOPCAJ2WN

Mahogany, matte
TOPCAJ2MH

4

BACK

SOUND PORT FOR CLEAR PROJECTION



Black, matte
TCAJ1BK

5 **NEW**



MESC

6

INTERNAL SNARE WIRES



Natural/Ebony Black, matte
BCA2NT/EBK-M

DIFFERENT SIZED CHAMBERS ENABLE AN AUTHENTIC BONGO EFFECT



Super Natural, matte
BCA1SNT-M

1 ARTISAN EDITION SLAPTOP CAJON, VIDALITA LINE
SIZE 17 3/4" W x 10" H x 12 1/2" D
MATERIALS Resonating body: 6 mm birch plywood; Playing surface: Palo Santo (*Bursera graveolens*)
FEATURES Enlarged Baltic Birch body with upward facing front port for deep bass; Eight pre-tuned custom micro-coiled steel cajon strings; Palo Santo playing surface with sensitive snare effect; Made in Spain

2 SLAPTOP CAJONS (PATENTED)
SIZES **TOPCAJ1** 14 1/2" W x 8 3/4" H x 5 3/4" D
TOPCAJ2 (Turbo Slaptop) 14 1/2" W x 10" H x 5 3/4" D
MATERIALS **TOPCAJ1EB** Resonating body: Baltic Birch (*Betula pendula*); Playing surface: Espresso Burst

TOPCAJ1MB
 Resonating body: Eco-friendly medium density fiberboard; Playing surface: Makah-Burl
TOPCAJ2MH (Turbo Slaptop)
 Resonating body: Baltic Birch (*Betula pendula*); Playing surface: Mahogany
TOPCAJ2WN (Turbo Slaptop)
 Resonating body: Eco-friendly medium density fiberboard; Playing surface: Walnut (*Juglans regia L.*)
FEATURES Comfortable upright playing style; Forward facing sound ports; Dual internal fixed snare wires; Deep bass and cutting slap tones
TOPCAJ2 (Turbo Slaptop)
 Snare on both sides

3 HYBRID SLAPTOP CAJON
SIZE 14 1/2" W x 10" H x 5 3/4" D
MATERIAL Baltic Birch (*Betula pendula*)

FEATURES Comfortable and unique X-design; Forward sound projection; Dual internal fixed snare wires for a snare cajon sound on one side; Bongo cajon sound on the opposite side

4 TRAVEL CAJON
SIZE 11 3/4"
MATERIAL Siam Oak (*Hevea brasiliensis* Muell.-Arg.)
FEATURES Internal snare wires; Compact design

5 ERGO SWIVEL CAJON
SIZE 11" W x 20" H x 4" & 6 1/4" D
MATERIAL Baltic Birch (*Betula pendula*)
FEATURES Play cajon in a seated position in a chair; Baltic birch construction with large bass port; Ergo shape for leg room; Internal snare wires

6 BONGO CAJONS
SIZE 15 3/4" W x 6 3/4" H x 7 1/4" D

BASS CAJONS



MATERIAL Siam Oak (*Hevea brasiliensis* Muell.-Arg.)
FEATURES High and low pitch playing surface; Compact size and light weight
BCA2: Dual internal fixed snare wires

7 JUMBO ARCH BASS CAJON

SIZE 16" W x 19 3/4" H x 13 1/2" D
MATERIALS Resonating body: Siam Oak (*Hevea brasiliensis* Muell.-Arg.); Frontplate: Maple
FEATURES Arched sides and back for low note development; Extra wide dimensions; Dual internal fixed snare wires; Enhanced boomy and punchy bass sounds

8 ARCH BASS CAJON

SIZE 15 1/4" W x 18" H x 12" D
MATERIALS Resonating body: Siam Oak (*Hevea brasiliensis* Muell.-Arg.); Frontplate: Maple

FEATURES Arched sides for low note development; Extra wide dimensions; Dual internal fixed snare wires

9 EBONY BASS FOOT SWITCH CAJON

SIZE 13 1/4" W x 19 3/4" H x 13 1/2" D
MATERIALS Resonating body: Baltic Birch (*Betula pendula*); Frontplate: Ebony
FEATURES Foot activated snare switch; Extra wide body for deep bass

10 MAPLE BASS CAJON

SIZE 13 1/2" W x 19 1/4" H x 14" D
MATERIALS Resonating body: Eco-friendly medium density fiberboard; Frontplate: Maple
FEATURES Jumbo bass size for optimal low notes; Dual internal fixed sets of snare wires

11 VERTICAL SUBWOOFER CAJON

SIZE 15 1/2" W x 19 1/4" H x 11 3/4" D

MATERIALS Resonating body: Eco-friendly medium density fiberboard; Frontplate: Makah-Burl
FEATURES Vertical forward facing sound ports; Dual internal fixed snare wires and bass reflex channel

12 SUBWOOFER CAJONS

SIZES **SUBCAJ1AWA** 11 3/4" W x 19 3/4" H x 12 1/4" D
SUBCAJ5WN 13 1/2" W x 19 3/4" H x 13 3/4" D
MATERIALS Resonating body: Eco-friendly medium density fiberboard
SUBCAJ1AWA Frontplate: American White Ash (*Fraxinus Americana* L.)
SUBCAJ5WN Frontplate: Walnut (*Juglans regia* L.)
FEATURES Forward projecting sound port; Dual internal fixed snare wires

PICKUP CAJONS

1 PIEZO PICKUP WITH VOLUME AND TONE CONTROL



SOLEÁ LINE

Dark Olive Burst
PAESLDOB

2



Baltic Birch
PWC100B

Makah-Burl
PWCP100MB

3



Baltic Birch
PSC100NT

Baltic Birch
PSC100B

4



Baltic Birch
PJC50B

5



Baltic Birch
PSUBCAJ6B

6 INDIVIDUAL SNARE AND BASS CONTROL



Walnut
PTOPCAJ2WN

Mahogany
PTOPCAJ4MH-M

1 ARTISAN EDITION PICKUP CAJON, SOLEÁ LINE

SIZE 11 1/4" W x 19" H x 11 3/4" D
MATERIALS Resonating body: 9-Ply (12 mm) Baltic Birch (*Betula pendula*)
 Frontplate: Dark Olive Burst
FEATURES Piezo pickup with volume and tone control; Two sets of 4 pre-tuned strings; Rounded corners and thumb notches for optimal playing comfort and sound; Ergonomically rounded frontplate with convex contact; Bass reflex system

2 PICKUP WOODCRAFT SERIES CAJONS

SIZE **PWCP100MB** (Woodcraft Professional) 11 3/4" W x 19 3/4" H x 12" D
PWC100B (Woodcraft) 11 3/4" W x 19 3/4" H x 12" D
MATERIALS Resonating body: Baltic Birch (*Betula pendula*)

PWCP100MB (Woodcraft Professional)

Frontplate: Makah-Burl
PWC100B (Woodcraft)
 Frontplate: Baltic Birch (*Betula pendula*)
FEATURES Three Piezo pickups for snare and bass sounds; Rubber feet and rear sound port
COLOURS **PWCP100MB**
 Resonating body: Black
PWC100B
 Resonating body: Natural

3 PICKUP SNARECRAFT SERIES CAJONS

SIZE 11 3/4" W x 19 3/4" H x 11 3/4" D
MATERIALS Resonating body: Baltic Birch (*Betula pendula*)
 Frontplate: Baltic Birch (*Betula pendula*)
FEATURES Three Piezo pickups for snare and bass sounds; Baltic birch construction
COLOURS **PSC100B**
 Resonating body: Black

PSC100NT

Resonating body: Natural

4 PICKUP JAM CAJON

SIZE 10 1/2" W x 15" H x 10" D
MATERIALS Resonating body: Baltic Birch (*Betula pendula*)
 Frontplate: Baltic Birch (*Betula pendula*)
FEATURES Compact size; Dual internal fixed snare wires; Piezo pickup with volume control
COLOUR Natural

5 PICKUP VERTICAL SUBWOOFER CAJON

SIZE 15 1/2" W x 19 1/4" H x 11 3/4" D
MATERIALS Resonating body: Eco-friendly medium density fiberboard
 Frontplate: Baltic Birch (*Betula pendula*)
FEATURES Vertical forward-facing sound ports; Piezo pickup with volume and tone control; Dual internal fixed snare wires



7





Birch Wood
MPDC1

DIGITAL CAJON FOR EXPANDED SOUND OPTIONS AND SILENT PRACTICE

DIGITAL CAJON SOUNDS

- 0 - MEINL Subwoofer Cajon + MEINL Tambourine
- 1 - MEINL Snarecraft Cajon + MEINL Splash Cymbal
- 2 - MEINL Cantina Line Artisan Cajon + MEINL Closed Hihat Cymbal
- 3 - MEINL Slaptop Cajon + Hand Clap
- 4 - MEINL Woodcraft Cajon + MEINL Crash Cymbal
- 5 - Rock Drum Kit + MEINL Closed Hihat Cymbal
- 6 - Drum Machine + MEINL Ride Cymbal
- 7 - MEINL Marathon® Classic Congas
- 8 - MEINL Fibercraft Bongos + MEINL Percussion Block
- 9 - MEINL Diego Galé Signature Timbales + MEINL Steel Craft Cowbell

9



Baltic Birch
MMCS

CAJON MICROPHONE STAND (SEE PAGE 98)



CMS

8

TWO 4.5" 20-WATT SPEAKERS



Baltic Birch
MPSCAJ

PRACTICE TO MUSIC OR INCORPORATE LOOPS IN YOUR PERFORMANCES

10



MIC-PERC

11



PA-CAJ

MICROPHONE CAJON CLAMP (SEE PAGE 105)



MPMCC

6 PICKUP SLAPTOP CAJONS (PATENTED)

SIZES **PTOPCAJ2WN** (Turbo Slaptop)
14 1/2" W x 10" H x 5 3/4" D
PTOPCAJ4MH-M
15 1/2" W x 8 1/2" H x 7 1/2" D

MATERIALS **PTOPCAJ2WN** (Turbo Slaptop)
Resonating body: Baltic Birch (*Betula pendula*)
Playing surface: Walnut (*Juglans regia* L.)
PTOPCAJ4MH-M
Resonating body: Eco-friendly medium density fiberboard
Playing surface: Mahogany

FEATURES Passive pickup system with high quality output jack; Individual snare, bass, and tone control; Playing surface with dual internal fixed snare wires; Forward facing sound ports
PTOPCAJ2WN (Turbo Slaptop)
Snares on both sides

7 DIGITAL CAJON

SIZE 12" W x 20" H x 12" D

MATERIALS Resonating body: Birch Wood
Playing surface: Open cell acoustic foam

FEATURES Four rubber trigger pads in a natural cajon playing position; Ten pre-programmed digital sounds

INCLUDES Power supply; Foot switch

COLOUR Black

8 SPEAKER CAJON

SIZE 11 3/4" W x 19 3/4" H x 11 3/4" D

MATERIALS Resonating body: Baltic Birch (*Betula pendula*)
Frontplate: Baltic Birch (*Betula pendula*)

FEATURES Practice to music or incorporate loops in your performances; Supports wireless connection with your phone

INCLUDES Micro SD card

COLOUR Resonating body: Black

9 MINI CAJON SPEAKER

SIZE 5 3/4" W x 8 3/4" H x 5 3/4" D

MATERIALS Resonating body: 5-Ply (6 mm) Baltic Birch (*Betula pendula*)
Frontplate: Baltic Birch (*Betula pendula*)

FEATURES Listen to your favorite music or podcast; Supports wireless, USB and auxiliary connection; Great gift idea for percussionists

10 PERCUSSION MICROPHONE

FEATURES Low-profile condenser microphone with adhesive backing; Great for cajons, congas, djembes or frame drums

INCLUDES Eighth-inch cable to quarter-inch adapter

11 CAJON PREAMP

FEATURES Robust Cajon Pickup/Preamp; Wide range tone control; High-quality signal output; Fits most cajons

MINI & MAKE YOUR OWN CAJONS

1

MINIATURE SIZE OF A CAJON WITH INTERNAL FIXED SNARE WIRES



Almond Birch
MC1AB

Baltic Birch
MC1AB-B

Baltic Birch
MC1B

Burl Wood
MC1BW

Heart Ash
MC1HA



2

ALL NEEDED TOOLS INCLUDED



Burl Wood
DMYO-CAJ-BU

DELUXE MODEL
FEATURES LARGER SIZE

3



Baltic Birch
MYO-CAJ

4



Baltic Birch
MYO-BCAJ

5



MYO-TOOLS

3



Ovankol
MYO-CAJ-OV

ASSEMBLY INSTRUCTION COMES
IN DIFFERENT LANGUAGES

1 MINI CAJONS

SIZE 5 3/4" W x 8 3/4" H x 5 3/4" D

MATERIALS **MC1AB**
Resonating body: 5-Ply (6 mm)
Baltic Birch (*Betula pendula*)
Frontplate: Almond Birch (*Betula pendula*)

MC1AB-B
Resonating body: 5-Ply (6 mm)
Almond Birch (*Betula pendula*)
Frontplate: Baltic Birch (*Betula pendula*)

MC1B
Resonating body: 5-Ply (6 mm)
Baltic Birch (*Betula pendula*)
Frontplate: Baltic Birch (*Betula pendula*)

MC1BW
Resonating body: 5-Ply (6 mm)
Baltic Birch (*Betula pendula*)
Frontplate: Burl Wood

2 DELUXE MAKE YOUR OWN CAJON

MC1HA
Resonating body: 5-Ply (6 mm)
Baltic Birch (*Betula pendula*)
Frontplate: Heart Ash

FEATURES Internal fixed snare wires; Miniature size; Birch construction; Great gift idea

MAKE YOUR OWN 2 3 4

CONTAINS All of the materials and assembly instructions for completing the cajon

3 MAKE YOUR OWN CAJONS

SIZE 11 3/4" W x 18" H x 11 3/4" D

MATERIALS Resonating body: Baltic Birch (*Betula pendula*)
Frontplate: Burl Wood

INCLUDES All of the tools for completing the cajon

MATERIALS Resonating body: Baltic Birch (*Betula pendula*)
MYO-CAJ
Frontplate: Baltic Birch (*Betula pendula*)
MYO-CAJ-OV
Frontplate: Ovankol (*Guibourtia ehie*)
Steel snare wires

COLOUR Natural

4 MAKE YOUR OWN BONGO CAJON

SIZE 15 3/4" W x 6 3/4" H x 7 1/4" D

MATERIAL Baltic Birch (*Betula pendula*)

COLOUR Natural

5 MAKE YOUR OWN CAJON TOOL BOX

CONTAINS 1 x screwdriver; 1 x wood glue; 2 x tension straps; 2 x sanding pads (coarse and fine)

FEATURE One-stop shop for all necessary tools to complete the MEINL Make Your Own Cajons and Bongo Cajon

CAJON PEDALS



1

EASILY PLAY DOUBLE BASS PATTERNS ON YOUR CAJON

TMDCP

2

SPECIALLY POSITIONED CURVED STEEL BAR WITH DIRECT DRIVE

TMSTCP

3

ADJUSTABLE SPRING TENSION ON BOTH THE PEDAL AND THE MOUNT

TMCP

4

CAN BE PLAYED WITH YOUR HEEL OR TOES

TMSTCP-2

BASSBOX/ SNAREBOX PEDAL (SEE PAGE 35)

TMBP

5

FOR PRONOUNCED KICK SOUND

Foam rubber

CPB1

6

ADJUSTABLE BRASS JINGLES

Soft foam

CPB2

7

DELIVERS HEAVY, FULL STROKES

Polymer bristles

CPB3

8

FOR DEEP AND PUNCHY NOTES

Soft foam

CPB4

9

GREAT FOR LOW VOLUME SETTINGS

Artificial fur

CPB5

1 DOUBLE BASS DIRECT DRIVE CAJON PEDAL

MATERIAL Steel

FEATURES Easily play double bass patterns on your cajon; Two pedals connected into one unit; Direct drive system provides a smooth, responsive feel; Adjustable spring tension; Cradle-like mount fits any common cajon and keeps the pedals secure

INCLUDES Drum key

2 DIRECT DRIVE CAJON PEDAL

MATERIAL Steel

FEATURES Cradle-like mount fits all common cajons; Adjustable spring tension; Natural foot position for ease of use

3 CAJON PEDAL

MATERIALS Steel; Synthetic

FEATURES Cradle-like mount fits all common cajons; Ultra-smooth and durable cable; Position anywhere for optimal playability

INCLUDES Drum key; Soft foam beater

4 DIRECT DRIVE HEEL ACTIVATED CAJON PEDAL

MATERIAL Steel

FEATURES Simple design for steady bass drum rhythms; Cradle-like mount fits most cajons

5 HAMMER HEAD CAJON & BASS DRUM BEATER

MATERIAL Foam rubber

FEATURES Soft foam rubber draws a deep bass sound from cajons; Dual playing surfaces for a variety of boom and punch

6 JINGLE CONTACT CAJON & BASS DRUM BEATER

MATERIALS Soft foam rubber; Brass jingles

FEATURES Easily turn the jingles on or off as desired throughout your set

7 BRUSH CAJON & BASS DRUM BEATER

MATERIAL Rippled polymer bristles

FEATURES Extra thick set of wavy polymer bristles; Two adjustable control rings; Warm, slightly mellow attack

8 STANDARD CAJON & BASS DRUM BEATER

MATERIAL Soft foam rubber

9 WOOLLY MAMMOTH CAJON BEATER

MATERIALS Artificial fur; Soft foam

CAJON DRUM SETS

1



MORE INFO

MAY BE EASILY ARRANGED FOR RIGHT OR LEFT HANDED PLAYERS

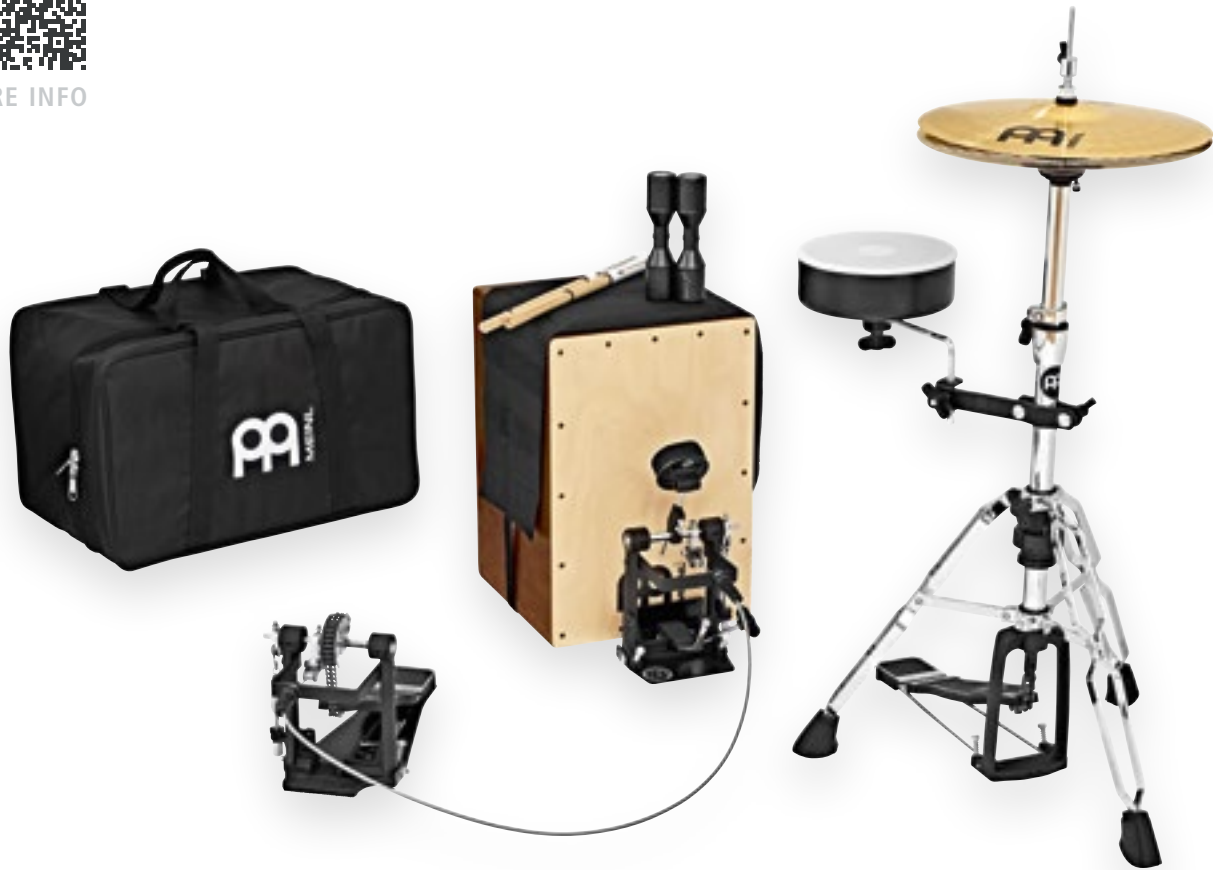

Set
CAJ-DRUMSET

PORTABLE RHYTHM STATION



2



MDTK

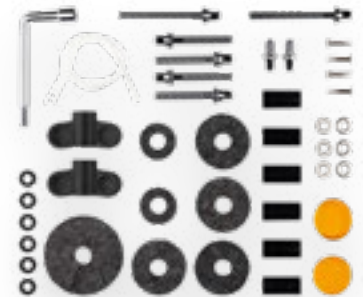

1 CAJON DRUM SET

CONTAINS Birch wood cajon without snares for enhanced bass
Cajon Pedal
Mountable Cajon Snare including silicone protection cover
Multi-Clamp
HCS 13" hi-hat cymbal pair with Low Hat
Bamboo Flex Multi-Rods for Cajon
Cajon Blanket with pockets for accessories
Luis Conte Live Shaker
Cajon Gig Bag

FEATURES

May be easily arranged for right or left handed players
This set includes everything needed for players looking to perform their normal drum set rhythms in smaller, intimate acoustic settings
The elements of this set give you the same feeling as sitting down at a drum kit

2 DRUM TECH KIT

CONTAINS 1 x L-Shaped Drum Key
4 x Drum Honey Gel Pads
6 x Synthetic Cymbal Sleeves
4 x Steel Cymbal Rivets
4 x Cymbal Felts
2 x Hi-hat Clutch Felts
1 x Hi-hat Base Felt
2 x 8 mm Wing Nuts
6 x Metal Washers
6 x Synthetic Washers
2 x Nylon Snare Cords
2 x Short Tension Rods
4 x Medium Tension Rods
2 x Long Tension Rods

FEATURES

Includes 14 of the most common and important tools for drummers and techs; For gig emergencies, routine maintenance, restoration or replacing lost parts

INCLUDES

Storage container for organization

CONVERTS ANY STANDARD CAJON INTO A BASS DRUM

3



MORE INFO



Set
CAJ-KIT

4

CUTTING SNARE SOUND



MCS1-BK



5

SHIELDS YOUR SNARE CAJON FROM STICK MARKS OR SCRATCHES



SCOVER



3 CAJON DRUM SET CONVERSION KIT

- CONTAINS** Direct Drive Cajon Pedal
Mountable Cajon Snare including silicone protection cover
Multi-Clamp
HCS 13" hihat cymbal pair with Low Hat
Bamboo Flex Multi-Rods for Cajon
Cajon Blanket with pockets for accessories
Luis Conte Live Shaker
Cajon Gig Bag

- FEATURES** Converts any standard cajon into a bass drum (cajon not included)
Expand your cajon into a small, reduced volume drum set
Low-key stage footprint
Perfect for acoustic shows, jam sessions, or street performances

4 MOUNTABLE CAJON SNARE

- SIZE** 7 1/2"
MATERIAL Siam Oak (*Hevea brasiliensis* Muell.-Arg.)
FEATURES Internal Snare Wires
Standard 3/8" rod mounting bracket
INCLUDES L-shaped rod with knurled surface
COLOUR **BK**: Black

5 SILICONE PROTECTION COVER

- SIZE** 7 1/2"
MATERIAL Silicone
FEATURES Shields your snare cajon from stick marks or scratches
Removable at any time

CAJON DRUM SETS

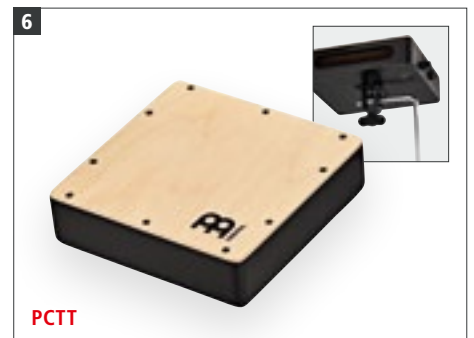
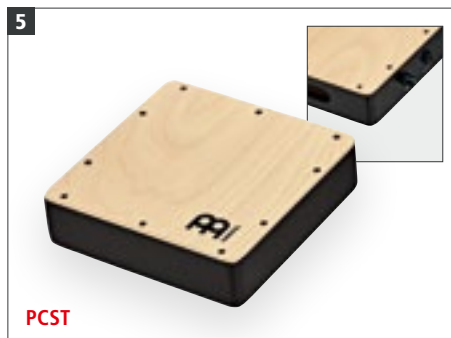

1 COCKTAIL CAJON KIT

CONTAINS Cocktail Cajon; Tom Tap; Snare Tap; Bongo Cajon Tap; Husk Brush (SB307); Foot Pedal (TMBP); Pedal Beater (CPB4); 3 x L-shaped rod (MC-R5); Splitter

2 COCKTAIL CAJON

SIZE 11 3/4" W x 19 3/4" H x 11 3/4" D
MATERIALS Resonating body: 7-Ply (9 mm) Baltic Birch (*Betula pendula*)
Frontplate: Baltic Birch (*Betula pendula*)
FEATURES Baltic birch cajon with forward facing ports and no snares for more bass; Bass drum pedal mount; Three clamps to attach percussion rods or cymbal arms (rods and arms sold separately); Piezo pickups for extra amplification

3 KICK DRUM CAJON

SIZE 11 3/4" W x 19 3/4" H x 11 3/4" D

MATERIALS Resonating body: 7-Ply (9 mm) Baltic Birch (*Betula pendula*)
Frontplate: Baltic Birch (*Betula pendula*)
FEATURES Plays just like a real kick drum; Multiple attachments to build an acoustic drum setup; Full size cajon without snares or strings for pure bass tone
INCLUDES Cymbal arm; Z-shape rod (plus mounts); pedal attachment plate; cajon beater

4 PICKUP BONGO CAJON

MATERIAL Baltic Birch (*Betula pendula*)
FEATURES High and low note playing areas; Piezo pickup and quarter-inch output jack

PICKUP CAJON TAPS 5 6

SIZE 10 3/4"
MATERIAL Baltic Birch (*Betula pendula*)
FEATURES Piezo pickup, quarter-inch output jack and volume knob; Ideal for acoustic shows

5 PICKUP CAJON SNARE TAP

FEATURE Hollow wooden body with internal snare produces a crisp snare drum sound

6 PICKUP CAJON TOM TAP

FEATURE Hollow wooden body produces a high-pitched tom sound

7 MERGER

MATERIAL Aluminum
FEATURES Combine multiple percussion audio signals into one output; Contains 6 inputs, 1 XLR output and 1 AUX input

8 INSTRUMENT CABLES

SIZES **MPIC-5:** 5 ft / 1.5 m
MPIC-10: 10 ft / 3 m
MPIC-15: 15 ft / 4.5 m
MPIC-20: 20 ft / 6 m
MPIC-30: 30 ft / 9 m



TMPPCS

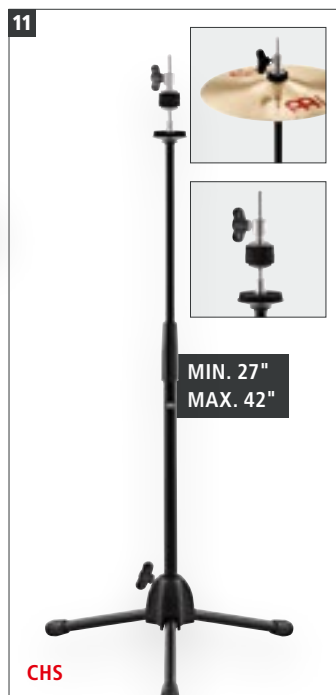

MIN. 27"
MAX. 42"

CHS

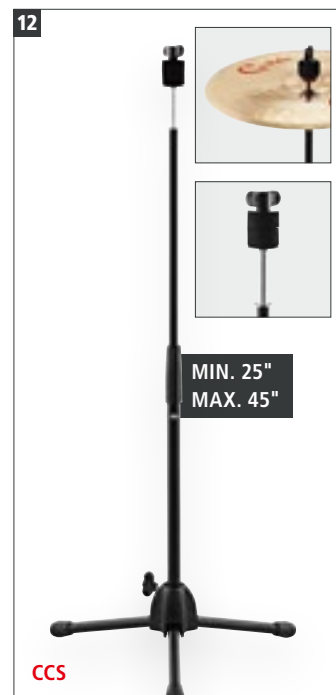

MIN. 25"
MAX. 45"

CCS



MIN. 22"
MAX. 37"

CAS



CJT



CST



CTT



INCLUDES SILICONE PROTECTION COVER

MCS2-BK

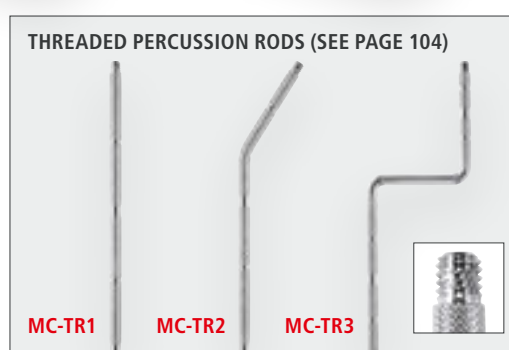

THREADED PERCUSSION RODS (SEE PAGE 104)

MC-TR1

MC-TR2

MC-TR3

FEATURES Great for all MEINL Percussion pickup instruments and Stomp Boxes; 8 mm diameter with high-quality 1/4" straight connectors; Wire gauge: 24 AWG

9 COCKTAIL CAJON INSTRUMENT CABLE SET

CONTAINS 4 x 5 ft Instrument Cable (MPIC-5)
1 x 30 ft Instrument Cable (MPIC-30)

FEATURE 5-piece MEINL Percussion Instrument Cable set for the MEINL Cocktail Cajon Kit

10 PROFESSIONAL PICKUP CAJON SNARE

SIZE 13" W x 6" H x 13" D
MATERIALS Resonating body: MDF
Playing surface: American White Ash (*Fraxinus Americana* L.)

FEATURES Dual internal sets of snares; Snare throw-off switch; Piezo pickup with bass and snare tone control

INCLUDES Standard Cajon Brushes (SB305)

CAJON DRUM SET STANDS 11 12 13

MATERIAL Black powder coated steel
FEATURE Foldable legs, height adjustable

11 CAJON HIHAT STAND

FEATURES Standard hihat clutch and padded seat; Fixed internal rod for closed hihat sound

12 CAJON CYMBAL STAND

FEATURES Standard cymbal stand top; Use with any cymbal type

13 CAJON ADD-ON STAND

FEATURE 3/8" threaded connector top

CAJON TAPS 14 15 16

SIZE 5 3/4"
MATERIAL Siam Oak (*Hevea brasiliensis* Muell.-Arg.)
FEATURE Threaded 3/8" connection underneath
FINISH Black

14 CAJON JINGLE TAP

FEATURE Stainless steel jingles for bright accents

15 CAJON SNARE TAP

FEATURE Internal snares for high pitched snare cajon sound

16 CAJON TOM TAP

FEATURE Hollow inside for a high pitched "tom" sound

17 MOUNTABLE CAJON SNARE WITH THREADED 3/8" CONNECTION

SIZE 7 1/2"
MATERIAL Siam Oak (*Hevea brasiliensis* Muell.-Arg.)
FEATURES Internal Snare Wires; Threaded 3/8" connection to mount on the MEINL Cajon Add-On Stand
INCLUDES Silicone Protection Cover
COLOUR **BK:** Black

CAJON ADD-ONS

1



DESIGNED TO HOLD OUR CAJON ADD-ONS CLOSE TO THE PLAYING SURFACE

Medium **CSM-M** Large **CSM-L**

2



WC1-M

3

STAINLESS STEEL JINGLES



WJC1-M

ADD NEW SOUNDS TO YOUR CAJON



4

STAINLESS STEEL JINGLES



JT-S-BK

5

EXTRA POCKET FOR SMALL PERCUSSION



CAJ-BLK

6

INTERNAL SNARE EFFECT



WSS1BK

7



Small **CCAB-S** Medium **CCAB**

8 **NEW**



TMCTK

- 1 CAJON SIDE MOUNTS**
SIZES **M:** Medium
L: Large
MATERIAL Siam Oak (*Hevea brasiliensis* Muell.-Arg.)
FEATURES Easy handling; Hook and loop fastener goes on any surface; Offers better cajon accessory placement
COLOUR Black
- 2 CAJON CASTANET**
SIZE **M:** Medium
MATERIAL Siam Oak (*Hevea brasiliensis* Muell.-Arg.)
FEATURES Spring-opened; Hook and loop fastener goes on any surface
COLOUR Black
FINISH Matte
- 3 CAJON JINGLE CASTANET**
SIZE **M:** Medium
MATERIAL Siam Oak (*Hevea brasiliensis* Muell.-Arg.)

- FEATURES** Spring-opened; Hook and loop fastener goes on any surface; Stainless steel jingles
COLOUR Black
FINISH Matte
- 4 JINGLE TAP**
SIZE Medium
MATERIAL Siam Oak (*Hevea brasiliensis* Muell.-Arg.)
FEATURES Stainless steel jingles; Hook and loop fastener goes on any surface
COLOUR **BK:** Black
- 5 CAJON BLANKET**
MATERIAL Heavy-duty nylon
FEATURES Fits on any cajon; Hook and loop fastener to mount additional add-ons
COLOUR Black
- 6 WOOD SIDE SNARE**
MATERIAL Siam Oak (*Hevea brasiliensis* Muell.-Arg.)

- FEATURES** Internal snare effect; Hook and loop fastener attaches to Cajon body; Ergonomic shape; Unobtrusive low profile
COLOUR **BK:** Black
FINISH Matte
- 7 CAJON TURBO CABASAS**
SIZES **CCAB-S:** Small
CCAB: Medium (traditional size)
MATERIALS Steel chain and stainless steel cylinder
FEATURES Add cabasa or loose hihat effects to cajon grooves; Five sound ports for extra projection
- 8 CAJON KINETIC TUNING KEY**
MATERIAL Molded ABS
FEATURES Adjust cajon string tension and cajon frontplate screws; Dual crosshead screw-driver and hex key; Wide wing MEINL logo designed for a firm grip



11 TRADITIONAL CASTANET SOUND



Wood **CRC1BK** Synthetic **PCRC1BK**

12



Stainless steel jingles **FJS1S-BK** Aluminum jingles **FJS1A-BK**

13 **NEW**



MCPM

14 PROVIDES LOWER BODY SUPPORT FOR LONG SETS ON A CAJON



LCS-GR **LCS-VBR** **LCS-VR**

15 ELEGANT DESIGN AND ULTRA-COMFORTABLE FEEL



Black **DCS**

16 ASSURES MORE COMFORT AND A SAFE SEAT WHILE PLAYING



CAJ-PAD

17



Set, 5 pcs. **PP-2**



Bordeaux **DCS-R**

9 KNEE PAD JINGLE TAP & KNEE PAD SNARE TAP
MATERIAL Siam Oak (*Hevea brasiliensis* Muell.-Arg.)
FEATURES Strap with hook and loop fastener to mount on your leg
KP-JT-BK: Stainless steel jingles
KP-ST-BK: Snare effect
COLOUR **BK:** Black

10 MOTION SHAKER
MATERIAL Synthetic
FEATURES Comfortable to wear on your fingers; Cutting shaker sound
COLOUR **BK:** Black

11 CAJON RING CASTANETS
SIZE Large
MATERIALS **CRC1BK:** Siam Oak (*Hevea brasiliensis* Muell.-Arg.)
PCRC1BK: Synthetic

COLOUR **BK:** Black
12 FINGER JINGLES
MATERIALS Siam Oak (*Hevea brasiliensis* Muell.-Arg.)
FJS1A: Aluminum jingles
FJS1S: Stainless steel jingles

13 CAJON PEDAL MOUNT
MATERIAL Baltic Birch (*Betula pendula*)
FEATURES Play your cajon just like a kick drum; Accommodates any size cajon; Fits all bass drum pedals; Adjustable wooden plate secures your cajon

14 SYNTHETIC LEATHER CAJON SEATS
MATERIAL Sleek faux leather
FINISHES **GR:** Grey
VBR: Vintage Brown
VR: Vintage Red

15 DELUXE CAJON SEATS
SIZE 9 3/4" x 9 1/2"
MATERIALS Inner material foam
 Outer material leatherette
FEATURES Provides comfort while sitting on your cajon; Filled with extra-thick padding; Elegant cross-stitching for high-end look and durability; Special underside surface grips any cajon (no adhesives necessary)
COLOURS **DCS:** Black
DCS-R: Bordeaux

16 CAJON PAD
SIZE 10" x 10"
MATERIAL Soft foam

17 CAJON PERC PACK
CONTAINS Cajon Pad; Compact Foot Tambourine; Motion Shaker; Cajon Castanet, large; Luis Conte Live Shaker

ROPE TUNED TRAVEL SERIES & JR. DJEMBS

1

NEW

SYNTHETIC HEAD

GALACTIC BLUE TIE DYE



12"
PADJ8-L-F

10"
PADJ8-M-F

DAY OF THE DEAD



12"
PADJ7-L-F

10"
PADJ7-M-F

KANGA SARONG



12"
PADJ6-L-F

10"
PADJ6-M-F

SIMBRA



12"
PADJ5-L-F

10"
PADJ5-M-F

PHARAOH'S SCRIPT



14"
PADJ1-XL-F

12"
PADJ1-L-F

10"
PADJ1-M-F

8"
PADJ1-S-F

KENYAN QUILT



14"
PADJ2-XL-F

12"
PADJ2-L-F

10"
PADJ2-M-F

8"
PADJ2-S-F

1 ROPE TUNED TRAVEL SERIES DJEMBS, SYNTHETIC HEAD (PATENTED)

- SIZES**
- S:** 8" diameter, 16" tall
 - M:** 10" diameter, 20" tall
 - L:** 12" diameter, 24" tall
 - XL:** 14" diameter, 26" tall
- HTP ROPES**
- S:** 4 mm thickness, 20 runners
 - M:** 4 mm thickness, 25 runners
 - L:** 4 mm thickness, 30 runners
 - XL:** 5 mm thickness, 35 runners

MATERIALS Synthetic shell; Synthetic head

FEATURES 100% synthetic heads and shells are perfect for outdoor playing; Ultra light weight makes them easy to carry; Pre-stretched HTP nylon ropes; Produces sharp slaps and deep bass tones; Non-slip rubber bottom to protect the drum from scratches

- FINISHES**
- PADJ1:** Pharaoh's Script
 - PADJ2:** Kenyan Quilt
 - PADJ5:** Simbra
 - PADJ6:** Kanga Sarong
 - PADJ7:** Day of the Dead
 - PADJ8:** Galactic Blue Tie Dye



SYNTHETIC DJEMBES



2 JR. DJEMBES

SIZE 7" diameter, 12 1/2" tall
ROPE 14 runners
MATERIALS Synthetic shell; Synthetic head
FEATURES Grab-and-go for any occasion, indoors or outside; Compact size and lightweight shell; Pre-stretched ropes; Produces sharp slaps and deep bass tones; 100% synthetic head and shell are perfect for outdoor playing
COLOURS **B:** Blue
BK: Black
G: Green
O: Orange
R: Red
S: Silver
Y: Yellow

FINISHES **GB:** Galactic Blue Tie Dye
KQ: Kenyan Quilt
PS: Pharaoh's Script
SI: Simbra
TA: Twisted Amber

3 ROPE TUNED TRAVEL SERIES DJEMBES, GOATSKIN HEAD (PATENTED)

SIZES **S:** 8" diameter, 16" tall
M: 10" diameter, 20" tall
L: 12" diameter, 24" tall
XL: 14" diameter, 26" tall
HTP ROPES **S:** 4 mm thickness, 20 runners
M: 4 mm thickness, 25 runners
L: 4 mm thickness, 30 runners
XL: 5 mm thickness, 35 runners

MATERIALS Synthetic shell
PADJ1, PADJ2 Hand selected goatskin head
PADJ4 Black coloured hand selected goatskin head
FEATURES Goatskin heads give you authentic sound and feel; Synthetic shells are perfect for outdoor playing; Ultra light weight makes them easy to carry; Pre-stretched HTP nylon ropes; Produces sharp slaps and deep bass tones; Non-slip rubber bottom to protect the drum from scratches
FINISHES **PADJ1:** Pharaoh's Script
PADJ2: Kenyan Quilt
PADJ4: Phantom Black

JUMBO DJEMBES



1 JUMBO DJEMBE SYNTHETIC HEADS

- SIZES** HEAD-JD12: 12"
HEAD-JD14: 14"
- MATERIAL** Synthetic head
- FEATURES** For the MEINL Jumbo Djembe
100% synthetic all-weather head
- FINISHES** DA: Day of the Dead
SI: Simbra
WH: White Fiberskin
Y: Yellow Fiberskin

2 JUMBO DJEMBS

- SIZES** JD12: 12" diameter, 24" tall
JD14: 14" diameter, 26" tall
- MATERIALS** Synthetic shell
Synthetic head
- FEATURES** Jumbo size for deep bass tone
100% all-weather synthetic shell and head
Easy to use mechanical tuning system
Lightweight construction to travel easily
- FINISHES** BW: Barnwood
DA: Day of the Dead
DA-DH: Day of the Dead, designer head
SI: Simbra
SI-DH: Simbra, designer head

ALPINE SERIES DJEMBES



1

NEW



GALACTIC BLUE TIE DYE



12" ADJ12-GB

10" ADJ10-GB

DAY OF THE DEAD



12" ADJ12-DA

10" ADJ10-DA

2

PIEZO PICKUP AND VOLUME CONTROL



BARNWOOD



12" PADJ12-BW

KANGA SARONG



12" ADJ12-KA

10" ADJ10-KA

SIMBRA



12" ADJ12-SI

10" ADJ10-SI

BARNWOOD



12" ADJ12-BW

10" ADJ10-BW

1 ALPINE SERIES DJEMBES

- SIZES** ADJ10: 10" diameter, 20" tall
ADJ12: 12" diameter, 24" tall
- MATERIALS** Synthetic shell
Synthetic head
- FEATURES** Durable, synthetic head and shell
Ultra light weight
Mechanical tuning system
Perfect for travel and outdoor performance
- FINISHES** BW: Barnwood
DA: Day of the Dead
GB: Galactic Blue Tie Dye
KA: Kanga Sarong
SI: Simbra

2 PICKUP ALPINE SERIES DJEMBE

- SIZE** 12" diameter, 24" tall
- MATERIALS** Synthetic shell
Synthetic head
- FEATURES** 100% synthetic djembe; Piezo pickup and volume control; Mechanically tuned head; Great for outdoor performances
- FINISH** BW: Barnwood

3-IN-1 DJEMBES (SEE PAGE 89)



VR-SDJSET-SH

SYNTHETIC DJEMBES

ROPE TUNED HEADLINER® SERIES WOOD DJEMBES



ROPE TUNED HEADLINER® SERIES WOOD DJEMBES 1 2 3 4

SIZES

- S:** 8" diameter, 15 3/4" tall
- M:** 10" diameter, 20" tall
- L:** 12" diameter, 24" tall
- XL:** 13" diameter, 25" tall

PP ROPES

- S:** 4 mm thickness, 16 runners
- M:** 4 mm thickness, 18 runners
- L:** 5 mm thickness, 20 runners
- XL:** 6 mm thickness, 24 runners

1 NILE SERIES

MATERIALS Mahogany Wood (*Swietenia macrophylla*)
Hand selected goatskin heads

FEATURES Carved from one solid piece of plantation grown Mahogany Wood
Pre-stretched PP nylon ropes
Hand carved shells

COLOUR Brown

2 BLACK RIVER SERIES

MATERIALS Mahogany Wood (*Swietenia macrophylla*)
Hand selected goatskin heads

FEATURES Carved from one solid piece of plantation grown Mahogany Wood
Pre-stretched PP nylon ropes
Hand carved shells

COLOUR Black

3 ARTIFACT SERIES

MATERIALS Mahogany Wood (*Swietenia macrophylla*)
Hand selected goatskin heads

FEATURES Carved from one solid piece of plantation grown Mahogany Wood
Pre-stretched PP nylon ropes
Hand carved shells

COLOUR Brown

4 CONGO SERIES

MATERIALS Mahogany Wood (*Swietenia macrophylla*)
Hand selected goatskin heads

FEATURES Carved from one solid piece of plantation grown Mahogany Wood
Pre-stretched PP nylon ropes
Hand carved shells
Ornamental carving

COLOUR Dark Brown

MINI & ROPE TUNED WOOD DJEMBES

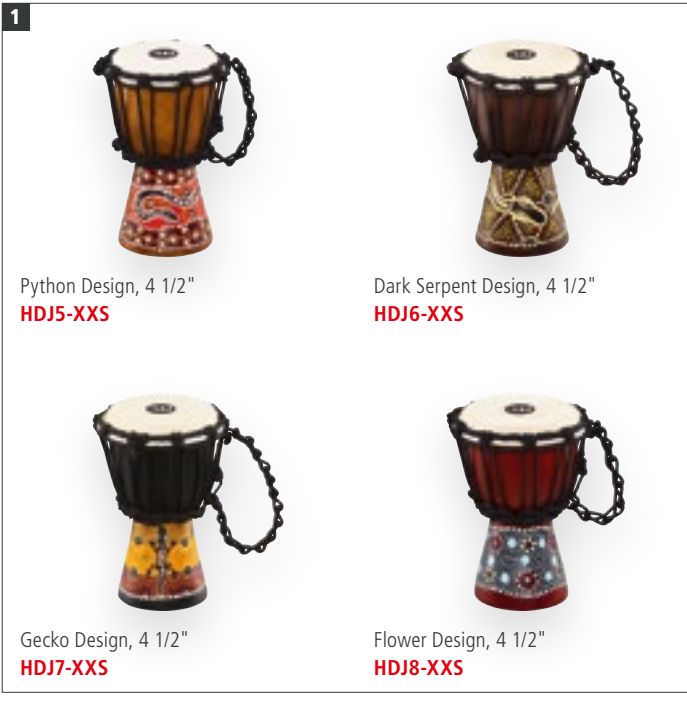

Python Design, 4 1/2"
HDJ5-XXS

Dark Serpent Design, 4 1/2"
HDJ6-XXS

Gecko Design, 4 1/2"
HDJ7-XXS

Flower Design, 4 1/2"
HDJ8-XXS



BLACK COLOURED HAND
SELECTED GOATSKIN HEADS



FIRE RHYTHM SERIES

13"
ADJ7-XL

12"
ADJ7-L

10"
ADJ7-M



EARTH RHYTHM SERIES

13", bundle with bag
ADJ3-XL+BAG

12", bundle with bag
ADJ3-L+BAG

10", bundle with bag
ADJ3-M+BAG



WATER RHYTHM SERIES

13", bundle with bag
ADJ2-XL+BAG

12", bundle with bag
ADJ2-L+BAG

10", bundle with bag
ADJ2-M+BAG

1 AFRICAN STYLE MINI DJEMBES

- SIZE** 4 1/2" (4 1/4" - 4 3/4") diameter, 8" tall
- PP ROPE** 3 mm thickness, 10 runners
- MATERIALS** Mahogany Wood (*Swietenia macrophylla*)
Hand selected goatskin head
- FEATURES** Carved from one solid piece of plantation grown Mahogany Wood
High quality PP nylon rope
Hand painted shell
- FINISHES** **HDJ5:** Python Design
HDJ6: Dark Serpent Design
HDJ7: Gecko Design
HDJ8: Flower Design

2 ORIGINAL AFRICAN STYLE ROPE TUNED WOOD DJEMBES

- SIZES** **M:** 10" (9 1/4" - 10 1/4") diameter, 20" tall
L: 12" (10 3/4" - 12 1/4") diameter, 24" tall
XL: 13" (12 3/4" - 13 3/4") diameter, 25" tall
- HTP ROPES** **M:** 4 mm thickness, 25 runners
L: 4 mm thickness, 35 runners
XL: 5 mm thickness, 35 runners
- MATERIALS** Mahogany Wood (*Swietenia macrophylla*)
Hand selected goatskin heads
- FEATURES** Carved from one solid piece of plantation grown Mahogany Wood
Pre-stretched HTP nylon ropes
Hand carved shells
Ornamental carving
- ADJ7**
Black coloured hand selected goatskin heads
Coloured rope wrapping

- INCLUDES** **ADJ2, ADJ3**
Professional Djembe Bag made out of heavy-duty padded nylon
- COLOURS** **ADJ2:** Brown
ADJ3: Brown/Black
ADJ7: Black

WOOD DJEMBES

PROFESSIONAL, ARTISAN & TONGO CARVED DJEMBES

1 SPECIAL "AFRICAN QUEEN" CARVING 





12" **PROADJ4-L** 10" **PROADJ4-M**

SPECIAL "VILLAGE" CARVING 



12" **PROADJ2-L** 10" **PROADJ2-M**

2 DELUXE CARVING 



14" **PROADJ3-XXL**

3 COLOURED ORNAMENTAL CARVING 



12" **AE-DJTC2-L**

4 

KES-01 

5 

DJTH 

DELUXE DJEMBE BAGS (SEE PAGE 107)



MDLXDJB-M **MDLXDJB-L**

1 PROFESSIONAL AFRICAN STYLE DJEMBES

SIZES **M:** 10" (9 1/4" - 10 1/4") diameter, 20" tall
L: 12" (10 3/4" - 12 1/4") diameter, 24" tall

HTP ROPES **M:** 4 mm thickness, 25 runners
L: 4 mm thickness, 35 runners

MATERIALS Mahogany Wood (*Swietenia macrophylla*)
 Hand selected goatskin heads

FEATURES Carved from one solid piece of plantation grown Mahogany Wood;
 Pre-stretched HTP nylon ropes
PROADJ2: "Village" carving
PROADJ4: "African Queen" carving

COLOUR Brown

2 ARTISAN EDITION DJEMBE

SIZE 14" (13 3/4" - 15 1/4") diameter, 26" tall

HTP ROPE 5 mm thickness, 40 runners

MATERIALS Mahogany Wood (*Swietenia macrophylla*)
 Hand selected goatskin head

FEATURES Carved from one solid piece of plantation grown Mahogany Wood; Pre-stretched HTP nylon rope; Deluxe carving

COLOUR Brown

3 ARTISAN EDITION TONGO CARVED DJEMBE

SIZE 12" (10 3/4" - 12 1/4") diameter, 24" tall

HTP ROPE 5 mm thickness, 30 runners

MATERIALS Mahogany Wood (*Swietenia macrophylla*)
 Hand selected goatskin head

FEATURES Carved from one solid piece of plantation grown Mahogany Wood; Pre-stretched HTP nylon ropes; Hand carved shell; Coloured ornamental carving

COLOUR Brown

4 KESSING

SIZE Medium

MATERIAL Aluminum

FEATURES Provides a dry rattling accompaniment to the drum; Slides securely into the webbing and is removable

5 DJEMBE TUNING HAMMER

MATERIAL Baltic Birch (*Betula pendula*)

FEATURES Use to tighten the tension on rope tuned djembes; Great for on-the-spot tuning adjustments

6 HEADLINER® SERIES WOOD DJEMBES

SIZE 12 1/2" diameter, 25 1/4" tall

MATERIALS Siam Oak (*Hevea brasiliensis* Muell.-Arg.)
 Hand selected goatskin head

FEATURES 8 mm strong tuning lugs;
 2.6 mm rounded rims;
 Original MEINL style tuning brackets;
 Black powder coated hardware;
 Sleek Hourglass shape for more comfort

INCLUDES Tuning key

HEADLINER® & FLOATUNE SERIES WOOD DJEMBES



WOOD DJEMBES

6 ORIGINAL MEINL STYLE TUNING BRACKETS

Vintage Wine Barrel, 12 1/2" **HDJ500VWB-M**

Natural, 12 1/2" **HDJ500NT**

7 FLOATUNE TUNING AVOIDS THE NEED TO DRILL THROUGH THE SHELL

Gold Amber Sunburst, 12" **DJW3GAB-M**

Natural, 12" **DJW3NT**

8 FLOATUNE TUNING SYSTEM

Zebra Finished Ash, 12" **DJW3ZFA-M**

9 DESIGNER DJEMBE STRAPS

Day of the Dead **MDJS1DA** Kanga Sarong **MDJS1KA** Kenyan Quilt **MDJS1KQ** Pharaoh's Script **MDJS1PS** Simbra **MDJS1SI**

10 PROFESSIONAL SHOULDER STRAP

MDJS2

COLOURS **NT:** Natural, high gloss
VWB-M: Vintage Wine Barrel, matte

7 FLOATUNE SERIES WOOD DJEMBES
SIZE 12" diameter, 24 1/4" tall
MATERIALS Siam Oak (*Hevea brasiliensis* Muell.-Arg.) True Skin Goat Head
FEATURES 8 mm strong tuning lugs; 3 mm rounded SSR-Rims; Easy tuning and comfortable change of heads; Rubber pads and lug placement offer perfect playing comfort; Floatune Tuning System; Chrome plated hardware
INCLUDES Accessory pouch
L-shaped tuning key
Tune Up Oil
COLOURS **GAB-M:** Gold Amber Sunburst, matte
NT: Natural, high gloss

8 FLOATUNE SERIES WOODCRAFT DJEMBE
SIZE 12" diameter, 24 1/4" tall
MATERIALS American White Ash (*Fraxinus americana* L.) True Skin Goat Head
FEATURES 8 mm strong tuning lugs; 3 mm rounded SSR-Rims; Easy tuning and comfortable change of heads; Rubber pads and lug placement offer perfect playing comfort; Floatune Tuning System; Chrome plated hardware
INCLUDES Accessory pouch
L-shaped tuning key
Tune Up Oil
COLOUR Zebra Finished Ash, matte

9 DESIGNER DJEMBE STRAPS
MATERIAL Heavy-duty nylon
FEATURES Holds your djembe in a secure playing position; For standing djembe players; Heavy-duty synthetic fabric that lasts; Adjustable webbed PP straps for a comfortable fit
COLOURS **DA:** Day of the Dead
KA: Kanga Sarong
KQ: Kenyan Quilt
PS: Pharaoh's Script
SI: Simbra

10 PROFESSIONAL SHOULDER STRAP
MATERIAL Heavy-duty nylon
FEATURES Holds any djembe or other drums in perfect playing position; Length adjustable; Adjustable shoulder padding; Quick change hook
COLOUR Black

JOURNEY & HEADLINER® BONGOS

1



Black, 6 1/2" & 7 1/2"
HB50BK



Forest Green, 6 1/2" & 7 1/2"
HB50FG



Flamingo Pink, 6 1/2" & 7 1/2"
HB50FP



Illuminating Yellow, 6 1/2" & 7 1/2"
HB50IY



Red, 6 1/2" & 7 1/2"
HB50R



Seafoam Green, 6 1/2" & 7 1/2"
HB50SF



Ultimate Grey, 6 1/2" & 7 1/2"
HB50UG



Creamsicle, 6 1/2" & 7 1/2"
HB50CS



Electric Coral, 6 1/2" & 7 1/2"
HB50EC

2



Natural, 6 3/4" & 8"
HB100NT



Vintage Sunburst, 6 3/4" & 8"
HB100VSB



Wine Red Burst, 6 3/4" & 8"
HB100WRB



Vintage Wine Barrel, 6 3/4" & 8"
HB100VWB-M



Glacier Blue, 6 1/2" & 7 1/2"
HB50GB



Walnut Brown, 6 3/4" & 8"
HTB100WB-M

MOLDED ABS

NEW

NEW

TRADITIONAL TTR-RIM

1 JOURNEY SERIES HB50 BONGOS

SIZES 6 1/2" Macho & 7 1/2" Hembra
MATERIALS Molded ABS
 Hand selected buffalo heads
FEATURES Black powder coated hardware
 Rounded rims for playing comfort
INCLUDES Tuning key
COLOURS **BK:** Black
CS: Creamsicle
EC: Electric Coral
FG: Forest Green
FP: Flamingo Pink
GB: Glacier Blue
IY: Illuminating Yellow
R: Red
SF: Seafoam Green
UG: Ultimate Grey

2 HEADLINER® SERIES HB100 & HTB100 WOOD BONGOS

SIZES 6 3/4" Macho & 8" Hembra
MATERIALS Siam Oak (*Hevea brasiliensis* Muell.-Arg.)
 Hand selected buffalo heads
FEATURES Black powder coated hardware
 8 mm strong tuning lugs
 Interior backing plates
HB100
 2 mm rounded rims for playing comfort
HTB100WB-M
 5 mm strong TTR-rims
INCLUDES Tuning key
COLOURS **NT:** Natural, high gloss
VSB: Vintage Sunburst, high gloss
VWB-M: Vintage Wine Barrel, matte
WB-M: Walnut Brown, matte
WRB: Wine Red Burst, high gloss

3 BONGO & PERCUSSION PACK

CONTAINS Journey Series HB50BK Bongo
 Compact Foot Tambourine
 Luis Conte Live Shaker
 Classic Wood Claves

4 HEADLINER® SERIES HFB100 FIBERGLASS BONGO

SIZES 6 3/4" Macho & 8" Hembra
MATERIALS Premium fiberglass
 Hand selected buffalo heads
FEATURES Black powder coated hardware
 8 mm strong tuning lugs
 2.6 mm rounded rims
INCLUDES Tuning key
COLOUR **BK:** Black

FIBERGLASS, WOOD & MARATHON® BONGOS



BONGOS

3 WITH JOURNEY SERIES HB50BK BONGO

Set, 4 pcs.
FPP-1

4 PREMIUM FIBERGLASS

Black, 6 3/4" & 8"
HFB100BK

5 CHROME PLATED ROUNDED SSR RIM

Natural, 6 3/4" & 8"
WB200NT-CH

6 CHROME PLATED ROUNDED SSR RIM

Natural, 6 3/4" & 8"
FWB200NT

6 GOLD TONE ROUNDED SSR RIM

Natural, 6 3/4" & 8"
WB200NT-G

6 CHROME PLATED ROUNDED SSR RIM

Super Natural, 6 3/4" & 8"
WB200SNT-M

6 GOLD AMBER SUNBURST, 6 3/4" & 8"

FWB200GAB

7 LEOPARD BURL, 6 3/4" & 8"

FWB190LB

7 AMBER FLAME, 6 3/4" & 8"

FWB190AF

8 NATURAL, 6 3/4" & 8"

FWB190NT

8 SUPER NATURAL, 6 3/4" & 8"

FWB190SNT-M

8 ANTIQUE TOBACCO BURST, 6 3/4" & 8"

FWB190ATB-M

5 WB200 WOOD BONGOS

SIZES 6 3/4" Macho & 8" Hembra
MATERIALS Siam Oak (*Hevea brasiliensis* Muell.-Arg.)
 Hand selected buffalo heads
FEATURES Solid woodblock connection; 8 mm strong tuning lugs; 2 mm rounded SSR-Rim
WB200NT-CH: Chrome plated hardware
WB200NT-G: Gold tone hardware
WB200SNT-M: Chrome plated hardware
INCLUDES Accessory pouch; L-shaped tuning key; Tune Up Oil
COLOURS **NT:** Natural, high gloss
SNT-M: Super Natural, matte

MARATHON® SERIES WOOD BONGOS

6 7 8
SIZES 6 3/4" Macho & 8" Hembra
MATERIALS Siam Oak (*Hevea brasiliensis* Muell.-Arg.)
 Hand selected buffalo heads
FEATURES MEINL Free Ride Suspension System; 8 mm strong tuning lugs
INCLUDES Accessory pouch; L-shaped tuning key; Tune Up Oil

6 MARATHON® EXCLUSIVE SERIES FWB200 WOOD BONGOS

FEATURES Chrome plated hardware; 2 mm rounded SSR-Rims
COLOURS **GAB:** Gold Amber Sunburst, high gloss
NT: Natural, high gloss

7 MARATHON® DESIGNER SERIES FWB190 WOOD BONGOS

FEATURES Unique designs; Black powder coated hardware; 2.5 mm rounded SSR-Rims
COLOURS **AF:** Amber Flame, high gloss
LB: Leopard Burl, high gloss

8 MARATHON® SERIES FWB190 WOOD BONGOS

FEATURES Black powder coated hardware; 2 mm rounded SSR-Rims
COLOURS **ATB-M:** Antique Tobacco Burst, matte
NT: Natural, high gloss
SNT-M: Super Natural, matte

BONGO HEADS & ARTIST, WOODCRAFT, COLLECTION,

1

REMO HEADS AVAILABLE

The REMO® R-Series Bongo Heads add more volume and resonance to your Bongo. These are available for bongos with this sign.

Fiberskyn®
RHEAD-7NT

Fiberskyn®
RHEAD-812NT

Nuskyn®
RHEAD-7NS

Nuskyn®
RHEAD-812NS

Black Calfskin Skyndeeep®
RHEAD-7BK

Black Calfskin Skyndeeep®
RHEAD-812BK

2

REMO HEADS AVAILABLE

TRADITIONAL TTR-RIM

Natural, 6 3/4" & 8"
LC300NT-M

Luis Conte

3

REMO HEADS AVAILABLE

TRUE SKIN CALF HEADS

Chamchuri Wood, 7" & 8 1/2"
DG400CW

REMO® FIBERSKYN® HEADS

Chamchuri Wood, 7" & 8 1/2"
DGR400CW

Diego Galé

4

REMO HEADS AVAILABLE

Vintage Black, 7" & 8 1/2"
WB400VBK-M

Vintage Brown, 7" & 8 1/2"
WB400VBR-M

Vintage Red, 7" & 8 1/2"
WB400VR-M

1 REMO® R-SERIES BONGO HEADS

SIZES **RHEAD-7:** 7" Macho
RHEAD-812: 8 1/2" Hembra

FIT FOR LC300, FFB400, FWB400, CS400, WB400, BWB400

FINISHES **BK:** Black Calfskin Skyndeeep®
NS: Nuskyn®
NT: Fiberskyn®

2 ARTIST SERIES LC300 WOOD BONGO LUIS CONTE

SIZES 6 3/4" Macho & 8" Hembra

MATERIALS Siam Oak (*Hevea brasiliensis* Muell.-Arg.) True Skin Cow Heads

FEATURES Solid woodblock connection; Black powder coated hardware; 8 mm strong tuning lugs; 5 mm traditional TTR-Rims

INCLUDES Accessory pouch; L-shaped tuning key; Tune Up Oil

COLOUR **NT-M:** Natural, matte

3 ARTIST SERIES WOOD BONGOS DIEGO GALÉ

SIZES 7" Macho & 8 1/2" Hembra

MATERIALS Chamchuri Wood
DG400CW: Hand selected cow heads
DGR400CW: REMO® Fiberskyn® Heads (For more volume and resonance)

FEATURES MEINL Free Ride Suspension System; Brushed nickel hardware; 8 mm strong tuning lugs; 3 mm rounded SSR-Rims; Resonance Shaping Area

COLOUR Natural, high gloss

WOODCRAFT, COLLECTION & PROFESSIONAL SERIES WOOD BONGOS

4 5 6 7 8

FEATURES MEINL Free Ride Suspension System; Chrome plated hardware; 8 mm strong tuning lugs; Resonance Shaping Area

INCLUDES Accessory pouch; L-shaped tuning key; Tune Up Oil

4 WOODCRAFT SERIES WB400 WOOD BONGOS

SIZES 7" Macho & 8 1/2" Hembra

MATERIALS American White Ash (*Fraxinus americana* L.) True Skin Cow Heads

FEATURE 3 mm rounded SSR-Rims

COLOURS **VBK-M:** Vintage Black, matte
VBR-M: Vintage Brown, matte
VR-M: Vintage Red, matte

5 WOODCRAFT SERIES BWB400 WOOD BONGO

SIZES 7" Macho & 8 1/2" Hembra

MATERIALS European Birch (*Betula pendula*) Hand selected cow heads

FEATURES Natural finish European Birch shells; 3 mm rounded SSR-Rims

COLOUR Natural

PROFESSIONAL, MINI & FIBERCRAFT BONGOS



BONGOS

5  
European Birch, 7" & 8 1/2"
BWB400

6 
Antique Mahogany Burst, 7" & 9"
WB500AMB

CHROME PLATED 5 MM TRADITIONAL TTR RIM

Zebra Finished Ash, 7" & 9"
WB500ZFA-M

7  
American White Ash, 7" & 8 1/2"
CS400AWA-M

8  
Natural, 7" & 8 1/2"
FWB400NT

Brown Burl, 7" & 8 1/2"
FWB400BB

9 **MINI!** 
Super Natural, 3 1/2" & 4 1/4"
FWB100SNT-M

Cherry Red, 7" & 8 1/2"
FWB400CR

Gold Amber Sunburst, 7" & 8 1/2"
FWB400GAB

10  **TRUE SKIN COW HEADS** 
Black, 7" & 8 1/2"
FFB400BK

REMO® BLACK CALFSKIN SKYNDDEEP® HEADS 
Black, 7" & 8 1/2"
FFBR400BK

PREMIUM FIBERGLASS 

6 WOODCRAFT SERIES
WB500 WOOD BONGOS
SIZES 7" Macho & 9" Hembra
MATERIALS American White Ash (*Fraxinus americana* L.)
True Skin Cow Heads
FEATURE 5 mm traditional TTR-Rims
COLOURS **AMB:** Antique Mahogany Burst, high gloss
ZFA-M: Zebra Finished Ash, matte

7 COLLECTION SERIES CS400 WOOD BONGO
SIZES 7" Macho & 8 1/2" Hembra
MATERIALS American White Ash (*Fraxinus americana* L.)
True Skin Cow Heads
FEATURE 3 mm rounded SSR-Rims
COLOUR **AWA-M:** American White Ash, matte

8 PROFESSIONAL SERIES
FWB400 WOOD BONGOS
SIZES 7" Macho & 8 1/2" Hembra
MATERIALS Siam Oak (*Hevea brasiliensis* Muell.-Arg.)
True Skin Cow Heads
FEATURE 3 mm rounded SSR-Rims
COLOURS **BB:** Brown Burl, high gloss
CR: Cherry Red, high gloss
GAB: Gold Amber Sunburst, high gloss
NT: Natural, high gloss

9 FWB100 MINI WOOD BONGO
SIZES 3 1/2" Macho & 4 1/4" Hembra
MATERIALS Siam Oak (*Hevea brasiliensis* Muell.-Arg.)
True Skin Buffalo Heads
FEATURES MEINL Free Ride Suspension System;
Chrome plated hardware;
2 mm rounded SSR-Rims
INCLUDES Tuning key
COLOUR **SNT-M:** Super Natural, matte

10 FIBERCRAFT SERIES FIBERGLASS BONGOS
SIZES 7" Macho & 8 1/2" Hembra
MATERIALS Premium fiberglass
FFB400BK: True Skin Cow Heads
FFBR400BK: REMO® Black Calfskin Skynddeep® Heads (For more volume and resonance)
FEATURES MEINL Free Ride Suspension System;
Chrome plated hardware; 8 mm strong tuning lugs; 3 mm rounded SSR-Rims;
Resonance Shaping Area
INCLUDES Accessory pouch; L-shaped tuning key;
Tune Up Oil
COLOUR **BK:** Black

CONGA HEADS & MINI CONGAS

1



The REMO® Symmetry Conga Heads add more volume and resonance to your Conga. These are available for congas with this sign.



Black Calfskin Skyndeeep® **RHEAD-11BK** Black Calfskin Skyndeeep® **RHEAD-1134BK** Black Calfskin Skyndeeep® **RHEAD-1212BK**



Black Calfskin Skyndeeep® **RTHEAD-11BK** Black Calfskin Skyndeeep® **RTHEAD-1134BK** Black Calfskin Skyndeeep® **RTHEAD-1212BK**



Fiberskyn® **RHEAD-11NT** Fiberskyn® **RHEAD-1134NT** Fiberskyn® **RHEAD-1212NT**



Nuskyn® **RTHEAD-11NS** Nuskyn® **RTHEAD-1134NS** Nuskyn® **RTHEAD-1212NS**

2



Natural, 4 1/2" **MC100NT**

Vintage Wine Barrel, 4 1/2" **MC100VWB**

Wine Red, 4 1/2" **MC100WR**

3



CONGA-SAVER8 **CONGA-SAVER10**

4



COMES IN A SET OF 4

Set **MCR-BK**

5

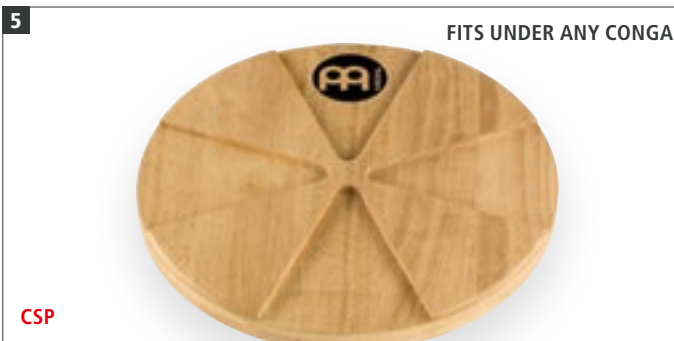

FITS UNDER ANY CONGA

CSP

1 REMO® SYMMETRY CONGA HEADS

SIZES **RHEAD-11:** 11" Quinto; SSR-Rim
RHEAD-1134: 11 3/4" Conga; SSR-Rim
RHEAD-1212: 12 1/2" Tumba; SSR-Rim
RTHEAD-11: 11" Quinto; TTR-Rim
RTHEAD-1134: 11 3/4" Conga; TTR-Rim
RTHEAD-1212: 12 1/2" Tumba; TTR-Rim
FIT FOR **RHEAD:** MCC, MEC, MP, FC, MSA, WKT, WCO, BWC
RTHEAD: LC
FINISHES **BK:** Black Calfskin Skyndeeep®
NS: Nuskyn®
NT: Fiberskyn®

2 MINI CONGAS

SIZE 4 1/2" wide, 11" tall
MATERIALS Siam Oak (*Hevea brasiliensis* Muell.-Arg.) Buffalo skin heads
FEATURES Contains every feature of a regular MEINL conga, at 2/5 the size Tunable buffalo skin head with 4 chrome lugs and rounded rim Great for spontaneous jam sessions or drum circles
COLOURS **NT:** Natural
VWB: Vintage Wine Barrel
WR: Wine Red

3 CONGA SAVERS

SIZES **CONGA-SAVER8:** for 8 mm tuning lugs
CONGA-SAVER10: for 10 mm tuning lugs
FEATURES Placed over the conga lugs to prevent them from damaging and scratching the shell Conga remains fully tunable
PATENT MEINL Conga Saver (TH, US patent)

4 CONGA RISERS

MATERIAL Sturdy rubber
FEATURES Raise your drums off the floor to allow maximum sound projection Provide a stable base on any surface Come in a set of four Flexible construction
COLOUR **BK:** Black

WOODCRAFT SERIES CONGAS



6

REMO
HEADS
AVAILABLE

VINTAGE BLACK

VINTAGE BROWN



11"
WCO11VBK-M

11 3/4"
WCO1134VBK-M

12 1/2"
WCO1212VBK-M



11"
WCO11VBR-M

11 3/4"
WCO1134VBR-M

12 1/2"
WCO1212VBR-M

VINTAGE RED



11"
WCO11VR-M

11 3/4"
WCO1134VR-M

12 1/2"
WCO1212VR-M

PROFESSIONAL CONGA DOUBLE
STAND WITH WHEELS
(SEE PAGE 96)



TMPDS

PROFESSIONAL CONGA STAND
WITH WHEELS
(SEE PAGE 97)



TMPC

5 CONGA SOUND PLATE

SIZE 13 1/4"
MATERIAL Siam Oak (*Hevea brasiliensis* Muell.-Arg.)
FEATURE Provides a hard sound reflective surface under your conga

6 WOODCRAFT SERIES WCO CONGAS

SIZES **WCO11:** 11" Quinto, 30" tall
WCO1134: 11 3/4" Conga, 30" tall
WCO1212: 12 1/2" Tumba, 30" tall

MATERIALS Three ply American White Ash (*Fraxinus americana* L.)
True Skin Buffalo Heads

FEATURES 10 mm strong tuning lugs
4 mm rounded SSR-Rims
Chrome plated hardware

INCLUDES MEINL Conga Saver (TH, US patent)
MEINL Conga Handle
MEINL Soundpads
Accessory pouch
L-shaped tuning key
Tune Up Oil

COLOURS **VBK-M:** Vintage Black
VBR-M: Vintage Brown
VR-M: Vintage Red

FINISH Matte

CONGAS

WOODCRAFT TRADITIONAL, FLOATUNE SERIES CONGAS

1

ZEBRA FINISHED ASH

PROFESSIONAL CONGA BAGS
(SEE PAGE 107)



11"
WC11ZFA-M

11 3/4"
WC1134ZFA-M

12 1/2"
WC1212ZFA-M

MCOB-11

MCOB-1134

MCOB-1212

2

NATURAL

THE FLOATUNE TUNING SYSTEM
ALLOWS THE SHELL TO
VIBRATE FREELY



10"
FL10NT

11"
FL11NT

12"
FL12NT

13"
FL13NT

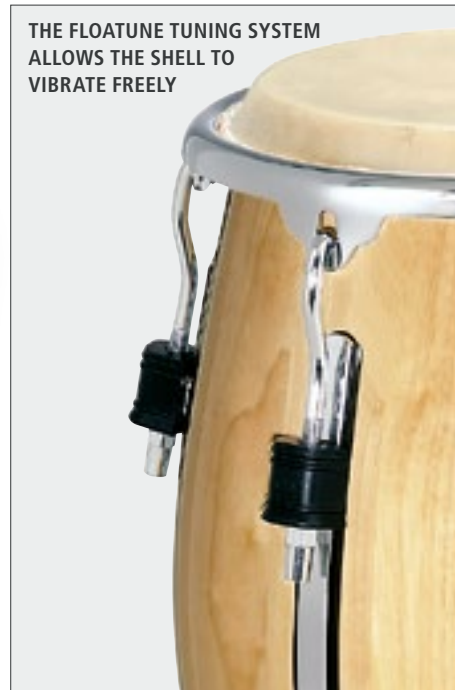

1 WOODCRAFT TRADITIONAL SERIES CONGAS

SIZES WC11: 11" Quinto, 30" tall
WC1134: 11 3/4" Conga, 30" tall
WC1212: 12 1/2" Tumba, 30" tall

MATERIALS Three ply American White Ash (*Fraxinus americana* L.)
True Skin Buffalo Heads

FEATURES 10 mm strong tuning lugs
5 mm traditional TTR-Rims
Chrome plated hardware

INCLUDES MEINL Conga Saver (TH, US patent)
MEINL Conga Handle
MEINL Soundpads
Accessory pouch
L-shaped tuning key
Tune Up Oil

COLOUR Zebra Finished Ash
FINISH Matte

2 FLOATUNE SERIES CONGAS

SIZES FL10: 10" Nino, 30" tall
FL11: 11" Quinto, 30" tall
FL12: 12" Conga, 30" tall
FL13: 13" Tumba, 30" tall

MATERIALS Two ply Siam Oak (*Hevea brasiliensis* Muell.-Arg.)
True Skin Buffalo Heads

FEATURES Floatune Tuning System
10 mm strong tuning lugs
4 mm rounded SSR-Rims
Chrome plated hardware

INCLUDES MEINL Conga Saver (TH, US patent)
MEINL Conga Handle
MEINL Soundpads
Accessory pouch
L-shaped tuning key
Tune Up Oil

COLOUR Natural
FINISH High gloss

PROFESSIONAL & FIBERCRAFT SERIES CONGAS



1 **REMO HEADS AVAILABLE**

NATURAL **BROWN BURL**

11" **MP11NT** 11 3/4" **MP1134NT** 12 1/2" **MP1212NT** 11" **MP11BB** 11 3/4" **MP1134BB** 12 1/2" **MP1212BB**

CONGAS

2 **REMO HEADS AVAILABLE**

TRUE SKIN BUFFALO HEADS **REMO® BLACK CALFSKIN SKYNDDEEP® HEADS**

11" **FC11BK** 11 3/4" **FC1134BK** 12 1/2" **FC1212BK** 11" **FCR11BK** 11 3/4" **FCR1134BK** 12 1/2" **FCR1212BK**

1 PROFESSIONAL SERIES CONGAS

- SIZES** **MP11:** 11" Quinto, 30" tall
MP1134: 11 3/4" Conga, 30" tall
MP1212: 12 1/2" Tumba, 30" tall
- MATERIALS** Two ply Siam Oak
(Hevea brasiliensis Muell.-Arg.)
 True Skin Buffalo Heads
- FEATURES** 10 mm strong tuning lugs
 4 mm rounded SSR-Rims
 Chrome plated hardware
- INCLUDES** MEINL Conga Saver (TH, US patent)
 MEINL Conga Handle
 MEINL Soundpads
 Accessory pouch
 L-shaped tuning key
 Tune Up Oil
- COLOURS** **BB:** Brown Burl
NT: Natural
- FINISH** High gloss

2 FIBERCRAFT SERIES CONGAS

- SIZES** **FC(R)11:** 11" Quinto, 30" tall
FC(R)1134: 11 3/4" Conga, 30" tall
FC(R)1212: 12 1/2" Tumba, 30" tall
- MATERIALS** Premium fiberglass
FC: True Skin Buffalo Heads
FCR: REMO® Black Calfskin Skynddeep® Heads (For more volume and resonance)
- FEATURES** 10 mm strong tuning lugs
 4 mm rounded SSR-Rims
 Chrome plated hardware
- INCLUDES** MEINL Conga Saver (TH, US patent)
 MEINL Conga Handle
 MEINL Soundpads
 Accessory pouch
 L-shaped tuning key
 Tune Up Oil
- COLOUR** **BK:** Black

REMO® SYMMETRY CONGA HEADS (SEE PAGE 66)



The REMO® Symmetry Conga Heads add more volume and resonance to your Conga. These are available for congas with this sign.



ARTIST SERIES CONGAS

1

TRUE SKIN BUFFALO HEADS

LC Conte



REMO HEADS AVAILABLE

REMO® NUSKYN® HEADS



11"
LC11NT-M

11 3/4"
LC1134NT-M

12 1/2"
LC1212NT-M

11"
LCR11NT-M

11 3/4"
LCR1134NT-M

12 1/2"
LCR1212NT-M

2

TRUE SKIN BUFFALO HEADS

"MONGO" Santamaria



REMO HEADS AVAILABLE



LUIS CONTE



"KACHIRO" THOMPSON



"MONGO" SANTAMARIA



DIEGO GALÉ

11"
MSA11AWA

11 3/4"
MSA1134AWA

12 1/2"
MSA1212AWA

1 ARTIST SERIES CONGAS LUIS CONTE

SIZES **LC(R)11:** 11" Quinto, 30" tall
LC(R)1134: 11 3/4" Conga, 30" tall
LC(R)1212: 12 1/2" Tumba, 30" tall

MATERIALS Two ply Siam Oak
(Hevea brasiliensis Muell.-Arg.)
LC: True Skin Buffalo Heads
LCR: REMO® Nuskyn® Heads
 (For more volume and resonance)

FEATURES 8 mm strong tuning lugs
 5 mm traditional TTR-Rims
 Black powder coated hardware

INCLUDES MEINL Conga Saver (TH, US patent)
 MEINL Soundpads
 Accessory pouch
 L-shaped tuning key
 Tune Up Oil

COLOUR **NT:** Natural

FINISH Matte

2 ARTIST SERIES CONGAS

RAMON "MONGO" SANTAMARIA

SIZES **MSA11:** 11" Quinto, 30" tall
MSA1134: 11 3/4" Conga, 30" tall
MSA1212: 12 1/2" Tumba, 30" tall

MATERIALS Two ply American White Ash
(Fraxinus americana L.)
 True Skin Buffalo Heads

FEATURES 10 mm strong tuning lugs
 4 mm rounded SSR-Rims
 Gold tone hardware

INCLUDES MEINL Conga Saver (TH, US patent)
 MEINL Soundpads
 Accessory pouch
 L-shaped tuning key
 Tune Up Oil

COLOUR **AWA:** American White Ash

FINISH High gloss



3 **REMO HEADS AVAILABLE** **HAND SELECTED MULESKIN HEADS** *Kachiro Thompson*

11" **WKT11NT** 11 3/4" **WKT1134NT** 12 1/2" **WKT1212NT**

REMO® BLACK CALFSKIN SKYNDDEEP® HEADS

11" **WKTR11NT** 11 3/4" **WKTR1134NT** 12 1/2" **WKTR1212NT**

4 **REMO HEADS AVAILABLE** **HAND SELECTED BUFFALO HEADS** *Diego Galé*

11" **DG11CW** 11 3/4" **DG1134CW** 12 1/2" **DG1212CW**

REMO® FIBERSKYN® HEADS

11" **DGR11CW** 11 3/4" **DGR1134CW** 12 1/2" **DGR1212CW**

3 ARTIST SERIES CONGAS

WILLIAM "KACHIRO" THOMPSON

SIZES **WKT(R)11:** 11" Quinto, 30" tall
WKT(R)1134: 11 3/4" Conga, 30" tall
WKT(R)1212: 12 1/2" Tumba, 30" tall

MATERIALS Three ply Siam Oak
(*Hevea brasiliensis* Muell.-Arg.)
WKT: Hand selected muleskin heads
WKTR: REMO® Black Calfskin Skynddeep® Heads (For more volume and resonance)

FEATURES 10 mm strong tuning lugs
4 mm rounded SSR-Rims
Gold tone hardware

INCLUDES MEINL Conga Saver (TH, US patent)
MEINL Conga Handle
MEINL Soundpads
Accessory pouch
L-shaped tuning key; Tune Up Oil

COLOUR FINISH **NT:** Natural
High gloss

4 ARTIST SERIES CONGAS DIEGO GALÉ

SIZES **DG(R)11:** 11" Quinto, 30" tall
DG(R)1134: 11 3/4" Conga, 30" tall
DG(R)1212: 12 1/2" Tumba, 30" tall

MATERIALS Two ply Chamchuri Wood
DG: Hand selected buffalo heads
DGR: REMO® Fiberskyn® Heads (For more volume and resonance)

FEATURES 10 mm strong tuning lugs
4 mm rounded SSR-Rims
Brushed nickel hardware

INCLUDES MEINL Conga Saver (TH, US patent)
MEINL Conga Handle
MEINL Soundpads
Accessory pouch
L-shaped tuning key
Tune Up Oil

COLOUR FINISH **CW:** Chamchuri Wood
High gloss

REMO® SYMMETRY CONGA HEADS
(SEE PAGE 66)



The REMO® Symmetry Conga Heads add more volume and resonance to your Conga. These are available for congas with this sign.



MARATHON® EXCLUSIVE & DESIGNER SERIES CONGAS



1 MARATHON® EXCLUSIVE SERIES CONGAS

SIZES **MEC(R)11:** 11" Quinto, 30" tall
MEC(R)1134: 11 3/4" Conga, 30" tall
MEC(R)1212: 12 1/2" Tumba, 30" tall

MATERIALS Two ply Siam Oak
(Hevea brasiliensis Muell.-Arg.)

MEC: True Skin Buffalo Heads
MECR: REMO® Fiberskyn® Heads
 (For more volume and resonance)

FEATURES 8 mm strong tuning lugs
 2.6 mm rounded SSR-Rims

CH: Chrome plated hardware
G: Gold tone hardware

INCLUDES Steely II Conga Stand (patented)
 MEINL Conga Saver (TH, US patent)
 MEINL Conga Handle
 MEINL Sound Pads
 Accessory pouch
 L-shaped tuning key
 Tune Up Oil

COLOUR **NT:** Natural
FINISH High gloss
PATENTS Steely-II patents:
 L-shaped leg and metal spike attachment
 (DE, TH, US patent)
 U-shaped notch (US patent)
 Ergonomic arched rubber bracing
 (CN, DE, TH, US patent)
 Notches for quick height adjustability
 (DE patent)

2 MARATHON® DESIGNER SERIES CONGAS

SIZES **MCC11:** 11" Quinto, 30" tall
MCC1134: 11 3/4" Conga, 30" tall
MCC1212: 12 1/2" Tumba, 30" tall

MATERIALS Two ply Siam Oak
(Hevea brasiliensis Muell.-Arg.)
 True Skin Buffalo Heads

FEATURES 8 mm strong tuning lugs
 2.6 mm rounded SSR-Rims
 Black powder coated hardware

INCLUDES Steely II Conga Stand (patented)
 MEINL Conga Saver (TH, US patent)
 Accessory pouch
 L-shaped tuning key
 Tune Up Oil

COLOUR **LB:** Leopard Burl
FINISH High gloss
PATENTS Steely-II patents:
 L-shaped leg and metal spike attachment
 (DE, TH, US patent)
 U-shaped notch (US patent)
 Ergonomic arched rubber bracing
 (CN, DE, TH, US patent)
 Notches for quick height adjustability
 (DE patent)

MARATHON® CLASSIC SERIES CONGAS



3

REMO HEADS AVAILABLE



NATURAL

STEELY II CONGA STAND

ERGONOMIC ARCHED RUBBER BRACING

U-SHAPED NOTCH

NOTCHES FOR QUICK HEIGHT ADJUSTABILITY

L-SHAPED LEG

METAL SPIKE ATTACHMENT



CONGAS

11"
MCC11NT

11 3/4"
MCC1134NT

12 1/2"
MCC1212NT



SUPER NATURAL



COFFEE BURST

11"
MCC11SNT-M

11 3/4"
MCC1134SNT-M

12 1/2"
MCC1212SNT-M

11"
MCC11CB

11 3/4"
MCC1134CB

12 1/2"
MCC1212CB

3 MARATHON® CLASSIC SERIES CONGAS

SIZES **MCC11:** 11" Quinto, 30" tall
MCC1134: 11 3/4" Conga, 30" tall
MCC1212: 12 1/2" Tumba, 30" tall

MATERIALS Two ply Siam Oak
(*Hevea brasiliensis* Muell.-Arg.)
True Skin Buffalo Heads

FEATURES 8 mm strong tuning lugs
2.6 mm rounded SSR-Rims
Black powder coated hardware

INCLUDES Steely II Conga Stand (patented)
MEINL Conga Saver (TH, US patent)
Accessory pouch
L-shaped tuning key
Tune Up Oil

COLOURS **CB:** Coffee Burst, high gloss
NT: Natural, high gloss
SNT-M: Super Natural, matte

PATENTS

Steely-II patents:
L-shaped leg and metal spike attachment (DE, TH, US patent)
U-shaped notch (US patent)
Ergonomic arched rubber bracing (CN, DE, TH, US patent)
Notches for quick height adjustability (DE patent)

REMO® SYMMETRY CONGA HEADS (SEE PAGE 66)



The REMO® Symmetry Conga Heads add more volume and resonance to your Conga. These are available for congas with this sign.

Fiberskyn®

Nuskyn®

Black Calfskin
Skyndee®



HEADLINER® & TRADITIONAL SERIES CONGAS



1 HEADLINER® SERIES CONGAS

SIZES	HC10: 10" Nino, 28" tall HC11: 11" Quinto, 28" tall HC12: 12" Conga, 28" tall
MATERIALS	Siam Oak (<i>Hevea brasiliensis</i> Muell.-Arg.) Hand selected buffalo heads
FEATURES	8 mm strong tuning lugs Original MEINL style tuning brackets 2 mm rounded rims Black powder coated hardware
INCLUDES	Height adjustable basket stands (patented) with quick set up system Tuning key
COLOURS	PBK-M: Phantom Black SNT-M: Super Natural VWB-M: Vintage Wine Barrel
FINISH	Matte

PATENTS	Basket stand patents: Ergo arched rubber bracing (CN, DE, TH, US patent) U-shaped notch (US patent) L-shaped leg (DE patent)
----------------	---

2 HEADLINER® TRADITIONAL SERIES CONGAS

SIZES	HTC10: 10" Nino, 28" tall HTC11: 11" Quinto, 28" tall HTC12: 12" Conga, 28" tall
MATERIALS	Siam Oak (<i>Hevea brasiliensis</i> Muell.-Arg.) Hand selected buffalo heads
FEATURES	8 mm strong tuning lugs Original MEINL style tuning brackets 5 mm traditional TTR-Rims Black powder coated hardware
INCLUDES	Height adjustable basket stands (patented) with quick set up system Tuning key
COLOUR	WB-M: Walnut Brown
FINISH	Matte
PATENTS	Basket stand patents: Ergo arched rubber bracing (CN, DE, TH, US patent) U-shaped notch (US patent) L-shaped leg (DE patent)

HEADLINER® SERIES CONGA SETS



3



Set, 10" & 11"
HC555NT



Set, 11" & 12"
HC512NT

NATURAL



Set, 10" & 11"
HC555VSB

VINTAGE SUNBURST



Set, 10" & 11"
HC888NT

THE BONGO MOUNT IS EASY MOUNTABLE ON OUR CONGA DOUBLE STANDS (SEE PAGE 96)



THBM



Set, 11" & 12"
HC512VSB



Set, 11" & 12"
HC812NT



Set, 10" & 11"
HC888VSB



Set, 11" & 12"
HC812VSB

3 HEADLINER® SERIES CONGA SETS

- SIZES** **HC555, HC888:** 10" Nino & 11" Quinto, 28" tall
HC512, HC812: 11" Quinto & 12" Conga, 28" tall
- MATERIALS** Siam Oak (*Hevea brasiliensis* Muell.-Arg.)
Hand selected buffalo heads
- FEATURES** 8 mm strong tuning lugs
Original MEINL style tuning brackets
2 mm rounded rims
Black powder coated hardware
- INCLUDES** Tuning key
HC555, HC512: Height adjustable basket stands (patented) with quick set up system
HC888, HC812: Height adjustable double braced tripod stand
- COLOURS** **NT:** Natural
VSB: Vintage Sunburst
- FINISH** High gloss

- PATENTS** Basket stand patents:
Ergo arched rubber bracing (CN, DE, TH, US patent)
U-shaped notch (US patent)
L-shaped leg (DE patent)

CONGAS

TIMBALES HEADS & HEADLINER®, MARATHON®,

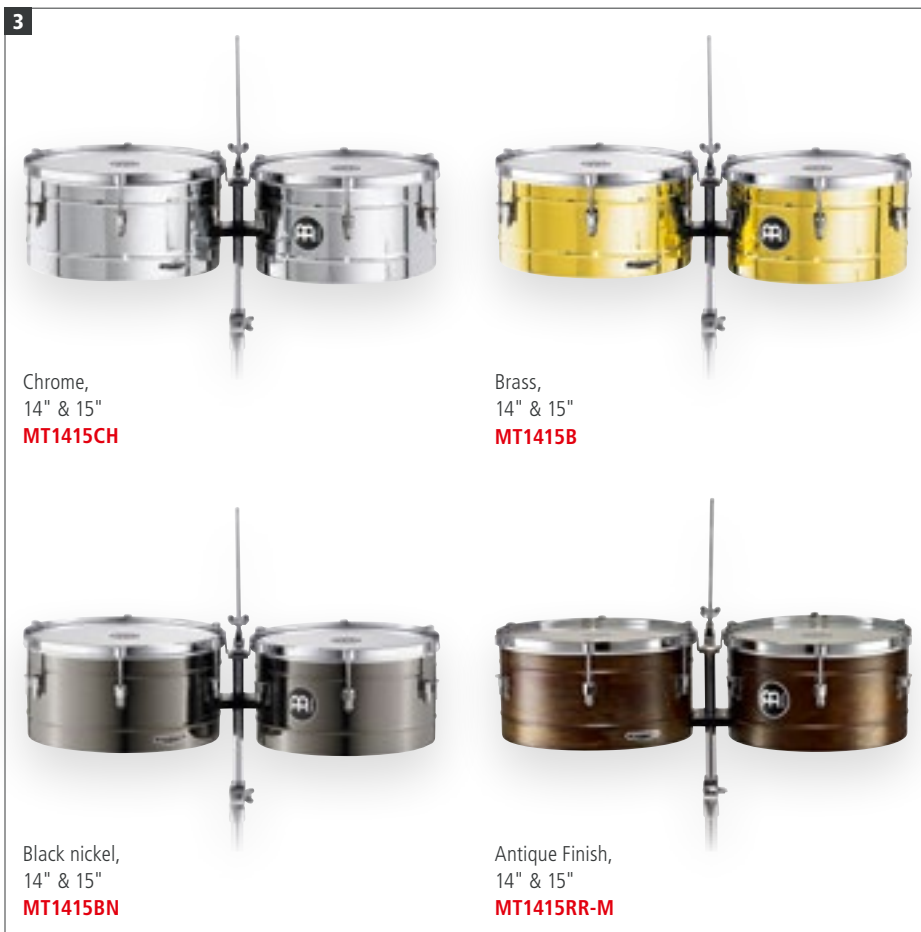
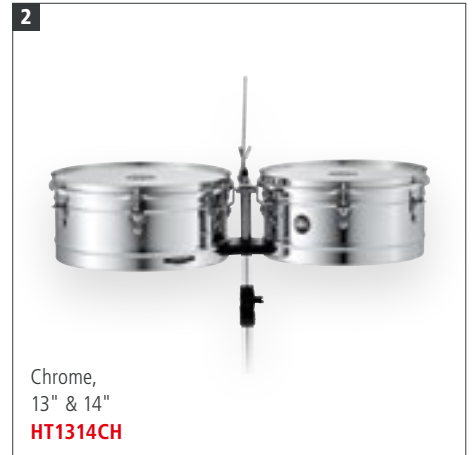

1 TIMBALES HEADS

SIZES **TBLH8BK:** 8" (Mini Timbales Head)
TBLH10BK: 10" (Mini Timbales Head)
TBLH13BK: 13"
TBLH14BK: 14"
TBLH15BK: 15"

MATERIAL Synthetic head

FEATURES Cutting and clean tone with effortless response; Extremely durable

COLOUR Black

2 HEADLINER® SERIES TIMBALES (PATENTED)

SIZES 13" & 14"

MATERIAL Steel

FEATURES Logo applied from underneath the head (CN, TH, US patent); Two worked-in flanges

INCLUDES Height adjustable tilting double braced tripod stand; Tuning key; Wrench; Cowbell holder

FINISH Chrome

3 MARATHON® SERIES TIMBALES (PATENTED)

SIZES 14" & 15"

MATERIAL Steel

FEATURES Two worked-in flanges; Heavy-duty style brackets; Logo applied from underneath the head (CN, TH, US patent)

INCLUDES Adjustable cowbell holder; Height adjustable tilting double braced tripod stand; Accessory pouch; L-shaped tuning key; Tune Up Oil

FINISHES **B:** Brass
BN: Black nickel
CH: Chrome
RR-M: Antique Finish, matte

4 MARATHON® SERIES TURBO TIMBALES (PATENTED)

SIZES 14" & 15", 10" deep

MATERIAL Black powder coated steel

FEATURES Three worked-in flanges; Heavy-duty style brackets; Logo applied from underneath the head (CN, TH, US patent)

INCLUDES Adjustable cowbell holder; Height adjustable tilting double braced tripod stand; Accessory pouch; L-shaped tuning key; Tune Up oil

COLOUR **BK:** Black

ARTIST SERIES, DRUMMER TIMBALES & HAND-BALE



TIMBALES

5

Antique bronze,
14" & 15"
AV1ABR

6

Solid brass,
14" & 15"
LC1BRASS

7

Stainless steel,
14" & 15"
LC1STS

7

Solid brass,
14" & 15"
DG1415

8

SPECIAL DESIGNED RIM

Black powder coated steel, 13"
MHT13BK

9

SNARE WIRES ARE ABSOLUTELY QUIET AND CHATTER-FREE IN THE "OFF" POSITION

Black powder coated steel, 8"
MDST8BK

Black powder coated steel, 10"
MDST10BK

10

Chrome, 8" & 10"
MIT810CH

Chrome, 13"
MDT13CH

ARTIST SERIES TIMBALES (PATENTED)

5 6 7

- SIZES** 14" & 15"
FEATURE Logo applied from underneath the head (CN, TH, US patent)
INCLUDES Adjustable cowbell holder; Accessory pouch; L-shaped tuning key; Tune Up Oil

5 ARTIST SERIES TIMBALES AMADITO VALDÉS

- MATERIAL** Steel
FEATURES Two worked-in flanges; Floatune Tuning System
INCLUDES Height adjustable tilting double braced tripod stand
COLOUR Antique bronze

6 ARTIST SERIES TIMBALES LUIS CONTE

- MATERIALS** **LC1BRASS**: Solid brass
LC1STS: Stainless steel

- FEATURES** Two worked-in flanges; Cuban style flared out bottom edge
INCLUDES Height adjustable tilting double braced tripod stand

7 ARTIST SERIES TIMBALES DIEGO GALÉ

- MATERIAL** Solid brass
FEATURE Classic Timbales shape and look
INCLUDES Professional Timbale Stand

8 ARTIST SERIES HAND-BALE TAKU HIRANO (PATENTED)

- SIZE** 13"
MATERIAL Black powder coated steel
FEATURE Logo applied from underneath the head (CN, TH, US patent)
INCLUDES L-shaped tuning key; Tune Up Oil
COLOUR **BK**: Black, high gloss

9 DRUMMER SNARE TIMBALES (PATENTED)

- SIZES** 8", 10"
MATERIAL Black powder coated steel
FEATURES Quick snare on/off system; Chatter-free "off" position; Logo applied from underneath the head (CN, TH, US patent)
INCLUDES L-shaped tuning key; Tune Up Oil
COLOUR **BK**: Black

10 DRUMMER TIMBALE & MINI TIMBALES (PATENTED)

- SIZES** **MDT13CH**: 13" (Drummer Timbale)
MIT810CH: 8" & 10" (Mini Timbales)
MATERIAL Steel
FEATURE Logo applied from underneath the head (CN, TH, US patent)
INCLUDES L-shaped tuning key; Tune Up Oil

MINI & STANDARD DARBUKAS



1 MINI DARBUKAS

SIZE 4 1/4" diameter, 7 3/4" tall
MATERIALS Aluminum shell;
 All-weather synthetic head
FEATURES Fun to play and easy to carry;
 Great gift idea
HE-050: Plain shell
HE-051: Hand hammered shell
HE-052: Hand engraved shell
HE-053: Lacquered shell
INCLUDES Tuning key

2 COPPER DARBUKAS, HAND ENGRAVED

SIZES **HE-204:** 7 1/2" diameter, 14 3/4" tall
HE-205: 7 7/8" diameter, 15 1/2" tall
MATERIALS Copper shell; Natural rawhide
FEATURE Hand engraved shell
INCLUDES Tuning key

3 COPPER DARBUKAS, BRASS PLATED, HAND HAMMERED

SIZES **HE-214:** 7 1/2" diameter, 14 3/4" tall
HE-215: 7 7/8" diameter, 15 1/2" tall
MATERIALS Copper shell; Synthetic head
INCLUDES Tuning key

4 ALUMINUM DARBUKAS, HAND ENGRAVED

SIZES **HE-122:** 6 1/2" diameter, 12 3/4" tall
HE-124: 8" diameter, 14 1/2" tall
MATERIALS Aluminum shell; Synthetic head
INCLUDES Tuning key

5 ALUMINUM JINGLE DARBUKAS, HAND HAMMERED

SIZES **HE-314:** 8" diameter, 14 1/2" tall
HE-315: 8 1/4" diameter, 16" tall
MATERIALS Aluminum shell; Synthetic head
FEATURES Built-in jingles; Hand hammered shell
INCLUDES Tuning key

6 ALUMINUM DARBUKAS, HAND HAMMERED

SIZES **HE-110:** 5 1/3" diameter, 9 1/4" tall
HE-111: 5 7/8" diameter, 11" tall
HE-112: 6 1/2" diameter, 12 3/4" tall
HE-113: 7 1/4" diameter, 13 1/3" tall
HE-114: 8" diameter, 14 1/2" tall
MATERIALS Aluminum shell; Synthetic head
FEATURE Hand hammered shell
INCLUDES Tuning key

7 ALUMINUM DARBUKAS, PLAIN

SIZES **HE-100:** 5 1/3" diameter, 9 1/4" tall
HE-101: 5 7/8" diameter, 11" tall
HE-102: 6 1/2" diameter, 12 3/4" tall
HE-103: 7 1/4" diameter, 13 1/3" tall
HE-104: 8" diameter, 14 1/2" tall
MATERIALS Aluminum shell; Synthetic head
INCLUDES Tuning key

ARTISAN EDITION, MINI & STANDARD DOUMBEKS



8 3/4", white
HEAD-136

8 3/4", black
HEAD-137

8 3/4", clear
HEAD-138



White Pearl, 8 3/4"
AEED1

White Pearl, 8 3/4"
AEED2

Blue Pearl, 8 3/4"
AEED3

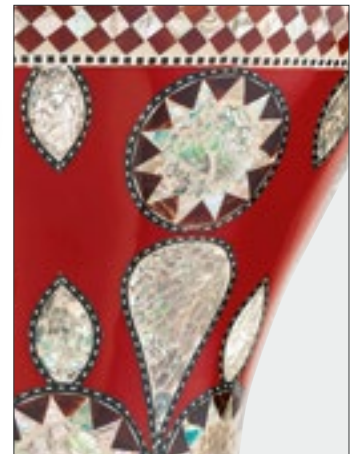

DARBUKAS & DOUMBEKS



4"
HE-1030

4"
HE-1018



10"
HE-3218

8 1/2"
HE-3018

6"
HE-2018

8 1/2"
HE-3039

HAND ENGRAVED SHELL

PAINTED FLORAL DESIGN



8 1/2"
HE-3012

HAND ENGRAVED SHELL



8 1/2"
HE-3030

HAND HAMMERED SHELL



10"
HE-3200

8 1/2"
HE-3000

6"
HE-2000

LEATHERETTE COVERED SHELL

8 ARTISAN EDITION EGYPT DOUMBEK HEADS

SIZE 8 3/4" diameter
MATERIAL Synthetic head
FEATURES Designed for the MEINL Artisan Edition Doumbeks
COLOURS **HEAD-136:** White
HEAD-137: Black
HEAD-138: Clear

9 ARTISAN EDITION EGYPT DOUMBEKS

SIZE 8 3/4" diameter, 17" tall
MATERIALS Aluminum shell; Synthetic head; Mother of pearl inlays
FEATURES Well balanced shape; Authentic Egyptian mosaic inlays; Produces outstanding dums and taks (teks)
INCLUDES Tuning key
DESIGNS **AEED1:** Mosaic Royale
AEED2: Mosaic Imperial
AEED3: Mosaic Palace

10 MINI DOUMBEKS

SIZE 4" diameter, 7 1/2" tall
MATERIALS Aluminum shell; Synthetic head
FEATURES **HE-1018:** Hand engraved shell
HE-1030: Hand hammered shell
INCLUDES Tuning key

11 ALUMINUM DOUMBEKS, HAND ENGRAVED

SIZES **HE-2018:** 6" diameter, 12" tall (Soprano)
HE-3018, HE-3039: 8 1/2" diameter, 17 1/8" tall
HE-3218: 10" diameter, 18 1/4" tall (Bass)
MATERIALS Aluminum shell; Synthetic head
FEATURES **HE-2018:** High pitched articulate sounds
HE-3039: Painted floral design
HE-3218: Super deep tones
INCLUDES Tuning key

12 COPPER DOUMBEK, HAND ENGRAVED

SIZE 8 1/2" diameter, 17 1/8" tall
MATERIALS Copper shell; Synthetic head
INCLUDES Tuning key

13 ALUMINUM DOUMBEK, HAND HAMMERED

SIZE 8 1/2" diameter, 17 1/8" tall
MATERIALS Aluminum shell; Synthetic head
INCLUDES Tuning key

14 ALUMINUM DOUMBEKS

SIZES **HE-2000:** 6" diameter, 12" tall (Soprano)
HE-3000: 8 1/2" diameter, 17 1/8" tall
HE-3200: 10" diameter, 18 1/4" tall (Bass)
MATERIALS Aluminum shell (leatherette covered); Synthetic head
FEATURES **HE-2000:** High pitched articulate sounds
HE-3200: Super deep tones
INCLUDES Tuning key
COLOUR Black

ALUMINUM SURDOS

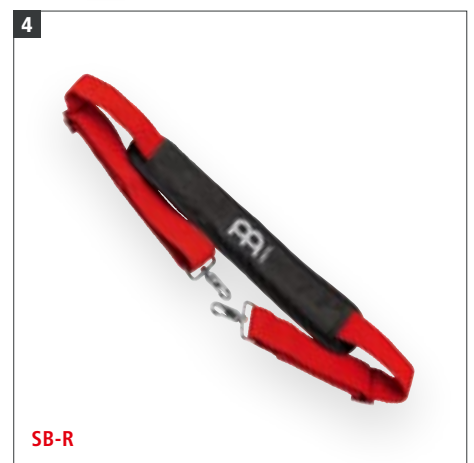

1 CLASSIC SERIES SURDOS (PATENTED)

SIZES **SUC16:** 16" diameter, 20" tall
SUC18: 18" diameter, 22" tall
SUC20: 20" diameter, 24" tall

MATERIAL Aluminum

FEATURES Countersunk bolt heads
Traditional rim
Chrome plated hardware
Traditional plain shell
8 tuning lugs (16" & 18" models)
10 tuning lugs (20" model)
Logo applied from underneath the head
(CN, TH, US patent)

INCLUDES Tuning key

2 BAHIA ALUMINUM SURDOS (PATENTED)

SIZES **SUB18:** 18" diameter, 16" tall
SUB20: 20" diameter, 16" tall
SUB22: 22" diameter, 18" tall

MATERIAL Aluminum

FEATURES Countersunk bolt heads
Chrome plated hardware
Two head options
8 tuning lugs (18" model)
10 tuning lugs (20" & 22" models)
Logo applied from underneath the head
(CN, TH, US patent)

INCLUDES Tuning key

3 TRADITIONAL ALUMINUM SURDOS (PATENTED)

SIZES **SU16:** 16" diameter, 20" tall
SU18: 18" diameter, 22" tall
SU20: 20" diameter, 24" tall
SU22: 22" diameter, 24" tall

MATERIAL Aluminum

FEATURES Countersunk bolt heads
Chrome plated hardware
Two head options
8 tuning lugs (16" & 18" models)
10 tuning lugs (20" & 22" models)
Logo applied from underneath the head
(CN, TH, US patent)
SU22-L, SU20-L, SU18-L, SU16-L:
Height adjustable legs

INCLUDES Tuning key



22" **HEAD-69** 20" **HEAD-68** 18" **HEAD-67** 16" **HEAD-66**



SHORTER SHELLS ENABLE TO WEAR IN MUCH LOWER POSITION

22" **SUB22AB-M** 20" **SUB20AB-M** 18" **SUB18AB-M**



22" **SU22AB-M** 20" **SU20AB-M** 18" **SU18AB-M** 16" **SU16AB-M**

SIX-PLY HARDWOOD SHELLS FOR A FULL AND WARM SOUND

SAMBA BEATERS (SEE PAGE 95)



SB1 **SB4** **SB5**

SURDO BEATER HOLDER (SEE PAGE 95)



SBH



22" **SU22-L-AB-M** 20" **SU20-L-AB-M** 18" **SU18-L-AB-M** 16" **SU16-L-AB-M**

HEIGHT ADJUSTABLE LEGS

4 SAMBA BELT

MATERIAL Cotton
FEATURES Length adjustable
 Adjustable shoulder padding
 Strong attachment hooks
COLOUR **R:** Red

5 SURDO NAPA HEADS

SIZES **HEAD-66:** 16"
HEAD-67: 18"
HEAD-68: 20"
HEAD-69: 22"
MATERIALS Nylon and leather cloth
FEATURE Bonded in a hoop
COLOUR Black

6 BAHIA WOOD SURDOS (PATENTED)

SIZES **SUB18:** 18" diameter, 16" tall
SUB20: 20" diameter, 16" tall
SUB22: 22" diameter, 18" tall
MATERIAL Six-ply hardwood shells
FEATURES Countersunk bolt heads
 Chrome plated hardware
 Two head options
 8 tuning lugs (18" model)
 10 tuning lugs (20" & 22" models)
 Logo applied from underneath the head (CN, TH, US patent)
INCLUDES Tuning key
COLOUR **AB:** Antique Brown
FINISH Matte

7 TRADITIONAL WOOD SURDOS (PATENTED)

SIZES **SU16:** 16" diameter, 20" tall
SU18: 18" diameter, 22" tall
SU20: 20" diameter, 24" tall
SU22: 22" diameter, 24" tall
MATERIAL Six-ply hardwood shells
FEATURES Countersunk bolt heads
 Chrome plated hardware
 Two head options
 8 tuning lugs (16" & 18" models)
 10 tuning lugs (20" & 22" models)
 Logo applied from underneath the head (CN, TH, US patent)
SU22-L, SU20-L, SU18-L, SU16-L: Height adjustable legs
INCLUDES Tuning key
COLOUR **AB:** Antique Brown
FINISH Matte

TIMBAS, TANTAM, REBOLO, REPINIQUES & CUICAS

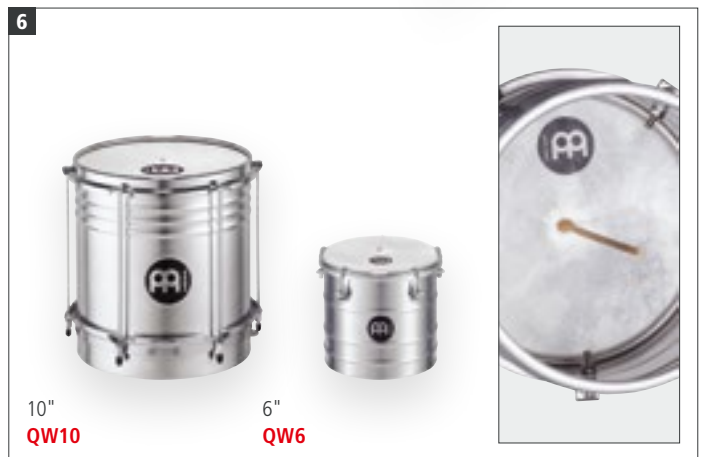
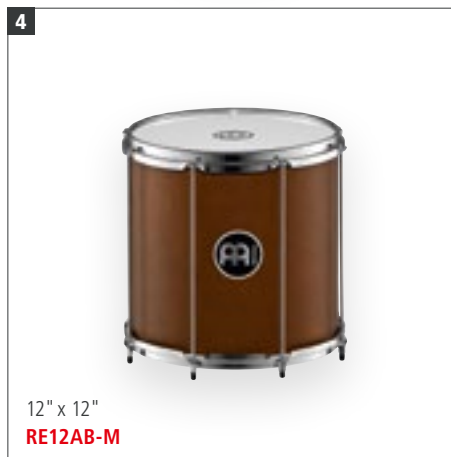

1 TIMBAS (PATENTED)

SIZES **TIM1428:** 14" diameter, 28" tall
TIM1435: 14" diameter, 35" tall

MATERIALS Poplar Wood (*Populus*)
Replaceable synthetic head

FEATURES Lightweight shell; Chrome plated hardware; Comfortable rounded rim; Strong hook to carry it on a belt; Logo applied from underneath the head (CN, TH, US patent)

INCLUDES Tuning key

COLOUR **AB-M:** Antique Brown, matte

2 TANTAM

SIZE 14" diameter, 28" tall

MATERIALS Poplar Wood (*Populus*)
Replaceable synthetic Napa head

FEATURES Lightweight shell; Chrome plated hardware; Strong hooks to carry it on a belt

INCLUDES Tuning key

COLOUR **AB-M:** Antique Brown, matte

3 REBOLO

SIZE 12" diameter, 18" tall

MATERIALS Poplar Wood (*Populus*)
Replaceable synthetic Napa head

FEATURES Lightweight shell; Chrome plated hardware; Mechanical lug tuning; Strong hooks to carry it on a belt

INCLUDES Tuning key

COLOUR **AB-M:** Antique Brown, matte

REPINIQUES 4 5

FEATURES Countersunk bolt heads; Chrome plated hardware; 6 tuning lugs (10" model); 8 tuning lugs (12" model); Logo applied from underneath the head (CN, TH, US patent)

INCLUDES Tuning key

4 WOOD REPINIQUE (PATENTED)

SIZE 12" diameter, 12" tall

MATERIALS Siam Oak (*Hevea brasiliensis* Muell.-Arg.)
Replaceable synthetic heads

COLOUR **AB-M:** Antique Brown, matte

5 ALUMINUM REPINIQUES (PATENTED)

SIZES **RE10:** 10" diameter, 10" tall
RE12: 12" diameter, 12" tall

MATERIALS Aluminum
Replaceable synthetic heads

6 ALUMINUM CUICAS

SIZES **QW6:** 6" diameter
QW10: 10" diameter

MATERIALS Aluminum
Hand selected goatskin heads

FEATURE **QW10:** Countersunk bolt heads

INCLUDES Tuning key

CAIXAS, TAMBORIMS & TAMPEIRO



SAMBA

7 **PROFESSIONAL SNARE THROW-OFF MECHANISM**

14" x 4"
CA14

12" x 4 1/2"
CA12

8 **TRADITIONAL STYLE WITH GUITAR STRINGS**

12" x 6"
CA12T

IMPROVED

9 **MESH HEAD FOR SUPER LOW VOLUME PRACTICE**

ABS, Black
STBR06ABS-BK

10

ABS, Black
TBR06ABS-BK

ABS, Green
TBR06ABS-GR

TAMBORIM STICKS (SEE PAGE 94)

TBRs-BK **TBRs-R**

ABS, Red
TBR06ABS-R

ABS, Yellow
TBR06ABS-Y

PROFESSIONAL TAMBORIM BAG (SEE PAGE 108)

MTAB-06

Aluminum
TBR06ALU

11

Siam Oak, Antique Brown
TP06AB-M

7 ALUMINUM CAIXAS (PATENTED)
SIZES **CA12:** 12" diameter, 4 1/2" tall
CA14: 14" diameter, 4" tall
MATERIALS Aluminum; Replaceable synthetic heads
FEATURES Countersunk bolt heads; Steel snare wires; Professional snare throw-off mechanism; Logo applied from underneath the head (CN, TH, US patent)
INCLUDES Tuning key

8 TRADITIONAL ALUMINUM CAIXA (PATENTED)
SIZE 12" diameter, 6" tall
MATERIALS Aluminum; Replaceable synthetic heads
FEATURES Traditional style snares made from guitar strings; Extra deep body; Countersunk bolt heads; Logo applied from underneath the head (CN, TH, US patent)
INCLUDES Tuning key

9 SILENT TAMBORIM
SIZE 6" diameter
MATERIALS Molded ABS
 Replaceable mesh head
FEATURE Floatune Tuning System; Countersunk bolt lugs; Mesh head for super low volume practice
INCLUDES Washer as tuning key
COLOUR **BK:** Black

10 FLOATUNE TAMBORIMS (PATENTED)
SIZE 6" diameter
MATERIALS Replaceable synthetic heads
ABS: ABS
ALU: Aluminum
FEATURES Floatune Tuning System; Countersunk bolt lugs; Logo applied from underneath the head (CN, TH, US patent)
INCLUDES Washer as tuning key

COLOURS **BK:** Black
GR: Green
R: Red
Y: Yellow

11 TAMPEIRO (PATENTED)
SIZE 6" diameter
MATERIALS Siam Oak (*Hevea brasiliensis* Muell.-Arg.)
 Replaceable synthetic head
 Three pairs of steel jingles
FEATURES Floatune Tuning System; Countersunk bolt lugs; Logo applied from underneath the head (CN, TH, US patent)
INCLUDES Washer as tuning key
COLOUR **AB:** Antique Brown

FRAME DRUMS



1 HAND DRUMS

SIZES **HD10:** 10"; **HD12:** 12"; **HD14:** 14"; **HD16:** 16"; **HD18:** 18"; **HD20:** 20"; **HD22:** 22"

MATERIALS Siam Oak (*Hevea brasiliensis* Muell.-Arg.)
AB: Hand selected goatskin head
AB-TF: True Feel synthetic head

COLOUR Antique Brown

2 TARS

SIZES **FD16:** 16", 2 1/2" deep
FD18: 18", 2 1/2" deep
FD20: 20", 2 1/2" deep
FD22: 22", 2 1/2" deep

MATERIALS Siam Oak (*Hevea brasiliensis* Muell.-Arg.)
T: Hand selected goatskin head
T-TF: True Feel synthetic head

FEATURE Internal tuning system

INCLUDES Hex key

COLOUR Antique Brown, matte

3 ARTISAN EDITION TARS (PATENTED)

SIZES **AE-FD14:** 14", 2 1/2" deep
AE-FD18: 18", 2 1/2" deep
AE-FD22: 22", 2 1/2" deep

MATERIALS Siam Oak (*Hevea brasiliensis* Muell.-Arg.)
 Hand selected goatskin head

FEATURES Special designed bearing edge (DE, US patent); Internal tuning system

INCLUDES Hex key

COLOUR Walnut Brown, matte

4 SEA DRUMS

SIZES **FD16:** 16", 2 3/4" deep
FD18: 18", 2 3/4" deep
FD20: 20", 2 3/4" deep
FD22: 22", 2 3/4" deep

MATERIALS Siam Oak (*Hevea brasiliensis* Muell.-Arg.)
 Transparent synthetic head and
SD: Hand selected goatskin head
SD-TF: True Feel synthetic head

FEATURES Steel balls inside; Sealable filling port

COLOUR Antique Brown, matte

5 MIZHARS

SIZES **FD12:** 12", 4" deep; **FD14:** 14", 4" deep;
FD18: 18", 4" deep

MATERIALS Siam Oak (*Hevea brasiliensis* Muell.-Arg.)
T-D: Hand selected goatskin head
T-D-TF: True Feel synthetic head

FEATURES Deep shell construction for full sound development; Internal tuning system

INCLUDES Hex key

COLOUR Brown Burl, matte

6 ARTISAN EDITION MIZHARS (PATENTED)

SIZES **AE-FD14:** 14", 4" deep
AE-FD18: 18", 4" deep
AE-FD22: 22", 4" deep

MATERIALS Siam Oak (*Hevea brasiliensis* Muell.-Arg.)
 Hand selected goatskin head

5 **HAND SELECTED GOATSKIN HEAD**

18" x 4" **FD18T-D**
14" x 4" **FD14T-D**
12" x 4" **FD12T-D**

TRUE FEEL SYNTHETIC HEADS

18" x 4" **FD18T-D-TF**
14" x 4" **FD14T-D-TF**
12" x 4" **FD12T-D-TF**

6

22" x 4" **AE-FD22T-D**
18" x 4" **AE-FD18T-D**
14" x 4" **AE-FD14T-D**

7 **HAND SELECTED GOATSKIN HEAD**

16" x 2 1/2" **FD16BE**
14" x 4" **FD14BE**
12" x 4" **FD12BE**

TRUE FEEL SYNTHETIC HEADS

16" x 2 1/2" **FD16BE-TF**
14" x 4" **FD14BE-TF**
12" x 4" **FD12BE-TF**

8 **METAL RINGS FOR SPECIAL EFFECTS**

20" x 2 1/2" **FD20D-TF**
20" x 2 1/2" **FD20D-WH**

9 **CROSS BAR**

18" x 4" **FD18BO**

10 **DAMPENING LAYER FOR LESS OVERTONES**

14" x 6" **FD14IBO**

11

7 1/2" **FD7KA**

13

Set, 4 pcs. **PL-SET**

12

15" **HOD15**
12 1/2" **HOD125**

FEATURES Special designed bearing edge (DE, US patent); Internal tuning system
INCLUDES Hex key
COLOUR Walnut Brown, matte

7 BENDIRS
SIZES **FD12:** 12", 4" deep; **FD14:** 14", 4" deep; **FD18:** 16", 2 1/2" deep
MATERIALS Siam Oak (*Hevea brasiliensis* Muell.-Arg.)
BE: Hand selected goatskin head
BE-TF: True Feel synthetic head
FEATURES Internal tuning system; Buzzing effect
INCLUDES Hex key
COLOUR Antique Brown, matte

8 DAFS
SIZE 20", 2 1/2" deep
MATERIALS Siam Oak (*Hevea brasiliensis* Muell.-Arg.)
FD20D-TF: True Feel synthetic head
FD20D-WH: Woven synthetic head

FEATURE Metal rings for special effects
COLOUR Antique Brown, matte

BODHRANS 9 10
MATERIALS Siam Oak (*Hevea brasiliensis* Muell.-Arg.)
Hand selected goatskin head
INCLUDES Hex key

9 CELTIC BODHRAN
SIZE 18", 4" deep
FEATURES Cross bar; Internal tuning system
COLOUR Antique Brown, matte

10 IRISH BODHRAN
SIZE 14", 6" deep
FEATURES Extra deep shell for full sound development; Dampening layer around rim for reduced overtones
COLOUR Brown Burl, matte

11 KANJIRA
SIZE 7 1/2", 2 1/4" deep
MATERIALS Siam Oak (*Hevea brasiliensis* Muell.-Arg.)
Hand selected goatskin head
FEATURES Many sound options; Set of 3 jingles
INCLUDES Hex key
COLOUR Antique Brown, matte

12 NATIVE AMERICAN-STYLE HOOP DRUMS
SIZES **HOD125:** 12 1/2"; **HOD15:** 15"
MATERIALS Hand selected buffalo head
Nylon lacing and grip
FEATURE Warm and powerful sound
INCLUDES Leather padded wooden beater

13 PLENERA SET
SIZES 8" Quinto; 10" Seguidor; 12" Tumbador
MATERIALS ABS molded frames; Goatskin heads
FEATURE External mechanical lug tuning
INCLUDES Nylon Bag; Tuning Key

RITUAL DRUMS

1



8 1/2" Bayan & 5 1/2" Dayan
TABLA

2

MADE BY MASTER CRAFTSMEN IN INDIA



9" Bayan & 5 1/2" Dayan
PRO-TABLA



3



ID10WH

4



ID3GO

RAWHIDE PLAYING SURFACE

5



THE FIBERGLASS LIQUID IBO DRUM IS FILLED WITH WATER

ID9BK/WH

PROFESSIONAL DOUMBЕК/IBO STAND (SEE PAGE 99)



TMID

4



ID4BKO

EXTRA FIBERGLASS PLAYING SURFACE

1 TABLA SET

- SIZES** 5 1/2" Dayan
8 1/2" Bayan
- MATERIALS** Chrome plated copper with goatskin head
Mahogany with goatskin head
- FEATURES** Authentic tabla heads
Nylon straps for longer durability
- INCLUDES** Padded support rings; Tuning hammer

2 ARTISAN EDITION TABLA SET

- SIZES** 5 1/2" Dayan
9" Bayan
- MATERIALS** Copper with goatskin head
Mahogany with goatskin head
- FEATURES** Top quality goatskin tabla heads
Traditional tuning system with rawhide thongs
- INCLUDES** Tuning hammer and wooden tuning dowel; Ring pads; Protective head covers

3 QUINTO IBO DRUM

- SIZE** Small
- MATERIAL** Ceramic
- FEATURES** Full and rich sounds
Built-in microphone hole
- COLOUR** **WH:** White

4 FIBERGLASS TRI SOUND IBO DRUMS

- SIZE** Large
- MATERIAL** Premium fiberglass
- FEATURES** Built-in microphone hole
Resistant shell construction
ID3GO: Rawhide playing surface
ID4BKO: Extra fiberglass playing surface
- INCLUDES** Foam padded base
- COLOUR** **BKO:** Black Ornament
GO: Gold Ornament

5 FIBERGLASS LIQUID IBO DRUM

- SIZE** Large
- MATERIAL** Premium fiberglass
- FEATURES** Special bottom, filled with water
Built-in microphone hole
Resistant shell construction
- INCLUDES** Foam padded base
- COLOUR** **BK/WH:** Black/White

6 BATAS

- SIZES** **BA1:** 5 1/4" & 8" Okonkolo
BA2: 5 3/4" & 8 3/4" Itotele
BA3: 6 3/4" & 12" Iya
- MATERIALS** Premium fiberglass
Hand selected buffalo heads
- FEATURE** Traditional TTR-Rims
- INCLUDES** Nylon strap; Tuning key
- COLOUR** **BK:** Black



6 3/4" & 12" Iya **BA3BK** 5 3/4" & 8 3/4" Itotele **BA2BK** 5 1/4" & 8" Okonkolo **BA1BK**



8" x 16" **ATD-L** 7" x 12" **ATD-M**

COMES WITH A CURVED WOODEN BEATER



11" **MTA1SNT-M**



BE1R



8" & 9" **HCG89NT**



SH-R

SHR-BR

NEARLY UNBREAKABLE

7 AFRICAN WOOD TALKING DRUMS

SIZES **M:** 7" diameter, 12" tall
L: 8" diameter, 16" tall
PP ROPES **M:** 3 mm thickness, 23 runners
L: 3 mm thickness, 28 runners
MATERIALS Mahogany Wood (*Swietenia macrophylla*)
Hand selected goatskin heads
FEATURE Nylon tuning strap
INCLUDES Curved wooden beater
FINISH Brown/Black

8 TAMBORA

SIZE 11"
MATERIALS Siam Oak (*Hevea brasiliensis* Muell.-Arg.)
True Skin Buffalo Heads
FEATURE Black powder coated hardware
INCLUDES Nylon strap; Wooden beaters; Tuning key
COLOUR **SNT-M:** Super Natural
FINISH Matte

9 BERIMBAU

MATERIAL Premium fiberglass
INCLUDES Small Caxixi; Metal plate; Wooden stick;
Carrying bag
COLOUR **R:** Red

10 WOOD CONGUITAS

SIZES 8" & 9"
MATERIALS Siam Oak (*Hevea brasiliensis* Muell.-Arg.)
Hand selected buffalo heads
FEATURES 8 mm strong tuning lugs; Original MEINL style tuning brackets; Traditional rims; Black powder coated hardware
INCLUDES Height adjustable tilting double braced tripod stand; Tuning key; Wrench
COLOUR **NT:** Natural
FINISH High gloss

11 SHEKERES

SIZES **SH-R:** Medium
SHR-BR: Medium
MATERIAL Premium fiberglass
COLOURS **BR:** Brown
R: Red

DRUM CIRCLE CAJONS



Snare Cajon
VR-CAJ-SO



Tri Tone Cajon
VR-TRICAJ-SO

3 DIFFERENT
SOUND OPTIONS



Cajon2Go
VR-CAJ2GO

POPS UP FROM A
FLAT PIECE INTO A
FULL SIZE CAJON



caiXoN
VR-CAIX

caiXoNet
VR-CAIXN

Set, 2 pcs.
VR-CAIX/CAIXN

FORWARD FACING SOUND PORT



STACKABLE FOR EASY STORAGE
AND TRANSPORTATION

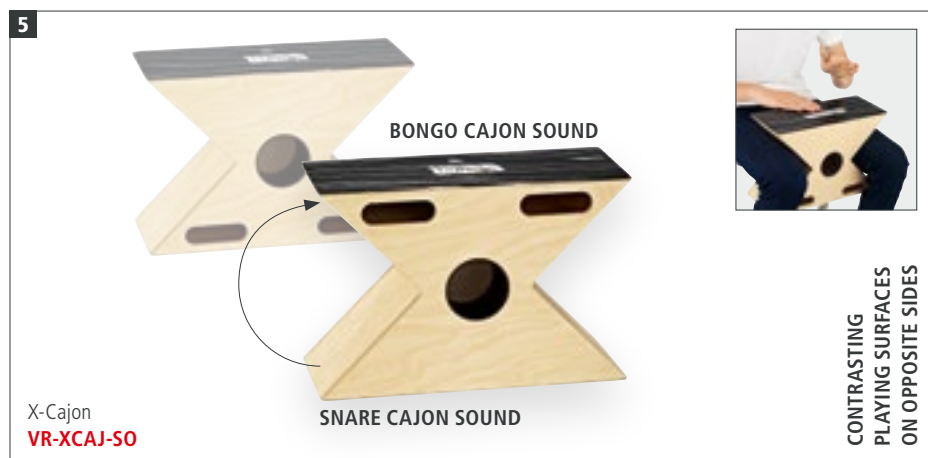

X-Cajon
VR-XCAJ-SO

SNARE CAJON SOUND

BONGO CAJON SOUND

CONTRASTING
PLAYING SURFACES
ON OPPOSITE SIDES



1 SNARE CAJON

SIZE 11 3/4" W x 17 3/4" H x 12" D
MATERIALS Resonating body: Baltic Birch (*Betula pendula*)
Frontplate: Striped Onyx
FEATURES Two internal snare wires
Birch construction
Four rubber feet
Wide sound options

2 TRI TONE CAJON

SIZE 11 3/4" W x 19 1/2" H x 13" D
MATERIALS Resonating body: Baltic Birch (*Betula pendula*)
Playing surfaces: Striped Onyx
FEATURES 3 different cajon sound options all in one unit: Bongo cajon (1); Snare cajon (2); Peruvian style cajon (3)
Two internal snare wires for the snare section

3 CAJON2GO

SIZE 13 1/2" W x 18" H x 12 1/2" D
MATERIAL Cardboard
FEATURES Folds from a single flat piece into a full size cajon
Internal fixed set of snare wires
Comfortably holds up to 150 kg / 330 lbs
Naturally deep bass and crisp snare sounds

4 CAIXON & CAIXONET

SIZES **VR-CAIX** (caiXoN)
11 1/2" W x 26 1/4" H x 12" D
VR-CAIXN (caiXoNet)
10 1/2" W x 26 1/4" H x 9 1/2" D
MATERIALS Resonating body: Baltic Birch (*Betula pendula*)
Playing surface: Striped Onyx
FEATURES Internal snare wires for cutting snare slaps

Perfect for seated players
Forward facing sound port
VR-CAIX: Deep bass tones
VR-CAIXN: Higher tones
VR-CAIX/CAIXN: Includes large caiXoN and smaller caiXoNet
Stackable for easy storage and transportation

5 X-CAJON

SIZE 14 1/2" W x 10" H x 5 3/4" D
MATERIALS Resonating body: Baltic Birch (*Betula pendula*)
Playing surfaces: Striped Onyx
FEATURES Comfortable and unique X-design
Forward sound projection
Internal snare wires for a snare cajon sound on one side
Bongo cajon sound on the opposite side

DRUM CIRCLE DJEMBEES



1

MAY BE PLAYED BY THEMSELVES AS A SMALL HAND DRUM

14" 12" 10" 9" 8" 14" 12" 10" 9" 8"

VR-POH14-SH VR-POH12-SH VR-POH10-SH VR-POH9-SH VR-POH8-SH VR-POH14-NH VR-POH12-NH VR-POH10-NH VR-POH9-NH VR-POH8-NH

DRUM CIRCLE INSTRUMENTS

2

BOOM SERIES

SOFT SOUND SERIES

CAN BE TAKEN OFF THE DRUM INSTANTLY WITHOUT ANY TUNING

14" x 26 1/4" 12" x 23" 10" x 19 1/2" 9" x 16 1/2" 8" x 16 1/4"

VR-SDJPO14-SH VR-SDJPO12-SH VR-SDJPO10-SH VR-SDJPO9-SH VR-SDJPO8-SH

14" x 26 1/4" 12" x 23" 10" x 19 1/2" 9" x 16 1/2" 8" x 16 1/4"

VR-SDJPO14-NH VR-SDJPO12-NH VR-SDJPO10-NH VR-SDJPO9-NH VR-SDJPO8-NH

3

BOOM SERIES

SOFT SOUND SERIES

Set, 3 pcs. VR-SDJSET-SH

THE POP OFF DJEMBE HEADS MAY BE PLAYED BY THEMSELVES AS A SMALL HAND DRUM

Set, 3 pcs. VR-SDJSET-NH

STACKABLE FOR EASY STORAGE AND TRANSPORTATION

1 POP OFF HEADS

SIZES VR-POH8: 8" head diameter
VR-POH9: 9" head diameter
VR-POH10: 10" head diameter
VR-POH12: 12" head diameter
VR-POH14: 14" head diameter

MATERIALS SH: Synthetic head
NH: Napa head

FEATURES Available as Napa style (soft sound) or standard synthetic (sharp sounds)
Instantly take on or off your MEINL VivaRhythm® Pop Off Djembe
May be played by themselves as a small hand drum
Nylon-loop for easy removal
Pre-tuned

2 POP OFF DJEMBEES

SIZES VR-SDJPO8: 8" head diameter, 16 1/4" height
VR-SDJPO9: 9" head diameter, 16 1/2" height
VR-SDJPO10: 10" head diameter, 19 1/2" height
VR-SDJPO12: 12" head diameter, 23" height
VR-SDJPO14: 14" head diameter, 26 1/4" height

MATERIALS Synthetic shell
SH: Synthetic head
NH: Napa head

FEATURES Synthetic shell is perfect for outdoor playing
Non-slip rubber bottom
Great for any skill level or style
SH: Removable, pre-tuned synthetic head for cutting sounds with sharp attack

NH: Removable, pre-tuned Napa head creates softer, warmer sound

3 3-IN-1 DJEMBEES

SIZES 8" head diameter, 16 1/4" height
10" head diameter, 19 1/2" height
12" head diameter, 23" height

MATERIALS Synthetic shell
SH: Synthetic head
NH: Napa head

FEATURES Synthetic shell is perfect for outdoor playing
Non-slip rubber bottom
Great for any skill level or style
Stackable for easy storage and transportation
SH: Pre-tuned synthetic head for cutting sounds with sharp attack
NH: Pre-tuned Napa head creates softer, warmer sound

DRUM CIRCLE CONGAS

1



11 1/2"
VR-POH115-SH

9 1/2"
VR-POH95-SH

8"
VR-POH8-SH



11 1/2"
VR-POH115-NH

9 1/2"
VR-POH95-NH

8"
VR-POH8-NH

MAY BE PLAYED BY THEMSELVES AS A SMALL HAND DRUM

2

CAN BE TAKEN OFF THE DRUM INSTANTLY WITHOUT ANY TUNING



BOOM SERIES

11 1/2" x 24 1/2"
VR-CPO115-SH

9 1/2" x 23"
VR-CPO95-SH

8" x 21"
VR-CPO8-SH

Set, 3 pcs.
VR-CPOSET-SH

STACKABLE FOR EASY STORAGE AND TRANSPORTATION



SOFT SOUND SERIES

11 1/2" x 24 1/2"
VR-CPO115-NH

9 1/2" x 23"
VR-CPO95-NH

8" x 21"
VR-CPO8-NH

Set, 3 pcs.
VR-CPOSET-NH

1 POP OFF HEADS

SIZES **VR-POH8:** 8" head diameter
VR-POH95: 9 1/2" head diameter
VR-POH115: 11 1/2" head diameter

MATERIALS **SH:** Synthetic head
NH: Napa head

FEATURES Available as Napa style (soft sound) or standard synthetic (sharp sounds)
Instantly take on or off your MEINL VivaRhythm® Pop Off Conga
May be played by themselves as a small hand drum
Nylon-loop for easy removal
Pre-tuned

2 POP OFF CONGAS

SIZES **VR-CPO8**
8" head diameter, 21" height
VR-CPO95
9 1/2" head diameter, 23" height
VR-CPO115
11 1/2" head diameter, 24 1/2" height
VR-CPOSET
8" x 21"; 9 1/2" x 23"; 11 1/2" x 24 1/2"

MATERIALS Synthetic shell
SH: Synthetic head
NH: Napa head

FEATURES Synthetic shell is perfect for outdoor playing
Non-slip rubber bottom
Great for any skill level or style
Stackable for easy storage and transportation
SH: Removable, pre-tuned synthetic head for cutting sounds with sharp attack
NH: Removable, pre-tuned Napa head creates softer, warmer sound

INCLUDES **VR-CPOSET:** Three wooden beaters

DRUM CIRCLE BASS DRUMS



1

REVERSE-DOT FOR DEEPER SOUNDS

14" **VR-POHBD14-SH**

12" **VR-POHBD12-SH**

10" **VR-POHBD10-SH**

14" **VR-POHBD14-NH**

12" **VR-POHBD12-NH**

10" **VR-POHBD10-NH**

2

CAN BE TAKEN OFF THE DRUM INSTANTLY WITHOUT ANY TUNING

BOOM SERIES

14" x 23 1/2" **VR-BDPO14-SH**

12" x 19 1/2" **VR-BDPO12-SH**

10" x 18" **VR-BDPO10-SH**

Set, 3 pcs. **VR-BDPOSET-SH**

STACKABLE FOR EASY STORAGE AND TRANSPORTATION

SOFT SOUND SERIES

14" x 23 1/2" **VR-BDPO14-NH**

12" x 19 1/2" **VR-BDPO12-NH**

10" x 18" **VR-BDPO10-NH**

Set, 3 pcs. **VR-BDPOSET-NH**

DRUM CIRCLE INSTRUMENTS

1 POP OFF BASS DRUM HEADS

SIZES **VR-POHBD10:** 10" head diameter
VR-POHBD12: 12" head diameter
VR-POHBD14: 14" head diameter

MATERIALS **SH:** Synthetic head
NH: Napa head

FEATURES Available as Napa style (soft sound) or standard synthetic (sharp sounds)
 Instantly take on or off your MEINL VivaRhythm® Pop Off Bass Drum
 Reverse Dot below the head for deeper sounds
 May be played by themselves as a small hand drum
 Nylon-loop for easy removal
 Pre-tuned

2 POP OFF BASS DRUMS

SIZES **VR-BDPO10**
 10" head diameter, 18" height
VR-BDPO12
 12" head diameter, 19 1/2" height
VR-BDPO14
 14" head diameter, 23 1/2" height
VR-BDPOSET
 10" x 18"; 12" x 19 1/2"; 14" x 23 1/2"

MATERIALS Synthetic shell
SH: Synthetic head
NH: Napa head

FEATURES Synthetic shell is perfect for outdoor playing
 Non-slip rubber bottom
 Great for any skill level or style
 Lower tones with great resonance
 Reverse Dot below the head for deeper sounds
 Stackable for easy storage and transportation
SH: Removable, pre-tuned synthetic head for cutting sounds with sharp attack
NH: Removable, pre-tuned Napa head creates softer, warmer sound

INCLUDES **VR-BDPOSET:** Three wooden beaters

DRUM CIRCLE STACK DRUM SETS, TIMBAS & MORE

1

BOOM SERIES



Set, 2 pcs.
VR-SDSET-SH

STACKABLE FOR EASY STORAGE AND TRANSPORTATION

SOFT SOUND SERIES



Set, 2 pcs.
VR-SDSET-NH

CAN BE TAKEN OFF THE DRUM INSTANTLY WITHOUT ANY TUNING

2

BOOM SERIES



12" x 28"
VR-T12-SH

SOFT SOUND SERIES



12" x 28"
VR-T12-NH

BASED ON THE SOUNDS OF TRADITIONAL SAMBA MUSIC

3



Molded ABS
VR-ABS1

4



Siam Oak
VR-TA2-ROM

5

RICH TONES



VR-HCB-R

6

PRECISE, CUTTING SOUND



Set, 2 pcs.
VR-ES2

7

SHAPES ANY GROOVE WITH CLARITY AND FEEL



VR-CSH

1 STACK DRUM SETS

SIZES 9 1/2" head diameter, 17 1/4" height
12" head diameter, 24" height

MATERIALS Synthetic shell
SH: Synthetic head
NH: Napa head

FEATURES Synthetic shell is perfect for outdoor playing; Stackable for easy storage and transportation; Non-slip rubber bottom; Great for any skill level or style
SH: Pre-tuned synthetic head for cutting sounds with sharp attack
NH: Pre-tuned Napa head creates softer, warmer sound

2 TIMBAS

SIZE 12" head diameter, 28" height

MATERIALS Fiberglass shell
SH: Synthetic head
NH: Napa head

FEATURES Based on the sounds of traditional Samba music; Non-slip rubber bottom
SH: Pre-tuned synthetic head for cutting sounds with sharp attack
NH: Pre-tuned Napa head creates softer, warmer sound

3 ABS PLASTIC TAMBOURINE

SIZE 8" diameter
MATERIALS Black plated steel jingles
Molded ABS

FEATURES Single row; Extra wide grip
FINISH Red/orange

4 WOOD TAMBOURINE

SIZE 10" diameter
MATERIALS Black plated steel jingles
Siam Oak (*Hevea brasiliensis* Muell.-Arg.)

FEATURES Double row; Ergonomic grip
FINISH Red/orange marble

5 HAND COWBELL

SIZE 8" long
MATERIALS Powder coated steel
Molded ABS

FEATURES Muffled, firm sound; Handheld; Rich tones
INCLUDES Cowbell beater with ribbed grip
COLOUR Red

6 EGG SHAKER PAIR

MATERIAL Synthetic
FEATURE Comes in a set of two
COLOUR Red/orange

7 CRYSTAL SHAKER

SIZE 8 1/4" long
MATERIALS Synthetic
Acrylic glass
FEATURES Shapes any groove with clarity and feel; Perfect for live playing
COLOUR Red/orange

DRUM CIRCLE BAGS



DRUM CIRCLE INSTRUMENTS

1 ADJUSTABLE BACKPACK STRAPS

VR-DJB-14 VR-DJB-12 VR-DJB-10 VR-DJB-9

2 CARRY ALL THREE SIZES OF MEINL VIVARHYTHM® CONGAS

VR-CSETB

3 CARRY ALL THREE SIZES OF MEINL VIVARHYTHM® BASS DRUMS

VR-BDSETB

4 CARRY BOTH SIZES OF MEINL VIVARHYTHM® STACK DRUM SET

VR-SDSETB

5 ADJUSTABLE BACKPACK STRAPS

VR-TB

6 ADJUSTABLE SHOULDER STRAP

VR-XCAJB

7 FITS MOST COMMON CAJON SIZES

VR-CAJB

8 ADJUSTABLE SHOULDER STRAP

VR-TRICAJB

9 FITS CAIXON AND CAIXONET STACKED OR INDIVIDUAL

VR-CAIXB

BAGS

MATERIAL Heavy-duty padded nylon
FEATURES Carrying handle with reinforced nylon stitching; Durable zipper
COLOUR Black

1 DJEMBE BAGS

SIZES
VR-DJB-9: 11 1/2" x 17 1/4"
VR-DJB-10: 11 3/4" x 19 3/4"
VR-DJB-12: 13 3/4" x 24 1/2"
VR-DJB-14: 15 3/4" x 27 1/2"
FEATURES Adjustable backpack straps
VR-DJB-9 Holds 8" & 9" diameter djembes
VR-DJB-10 Holds 10" diameter djembes
VR-DJB-12 Holds 12" diameter djembes
VR-DJB-14 Holds 14" diameter djembes

2 CONGA SET BAG

SIZE 13" x 26"
FEATURES Adjustable backpack straps; Carry all three sizes of MEINL VivaRhythm® Congas

3 BASS DRUM SET BAG

SIZE 16 1/4" x 25 1/4"
FEATURES Adjustable backpack straps; Carry all three sizes of MEINL VivaRhythm® Bass Drums

4 STACK DRUM SET BAG

SIZE 13 1/2" x 24 1/2"
FEATURES Adjustable backpack straps; Carry both sizes of MEINL VivaRhythm® Stack Drum Set

5 TIMBA BAG

SIZE 13 1/2" x 29"
FEATURE Adjustable backpack straps

6 X-CAJON BAG

SIZE 18 1/4" W x 13 1/2" H x 8" D
FEATURE Adjustable shoulder strap

7 CAJON BAG

SIZE 20 1/2" W x 13 1/2" H x 12" D
FEATURE Fits most common cajon sizes

8 TRI TONE CAJON BAG

SIZE 21" W x 13" H x 13 1/2" D
FEATURE Adjustable shoulder strap

9 CAIXON & CAIXONET BAG

SIZE 31" W x 12 1/2" H x 13 1/2" D
FEATURES Adjustable shoulder strap; Fits caiXoN and caiXoNet stacked or individual

STICKS, BEATERS, BRUSHES, MALLETS & SCRAPERS

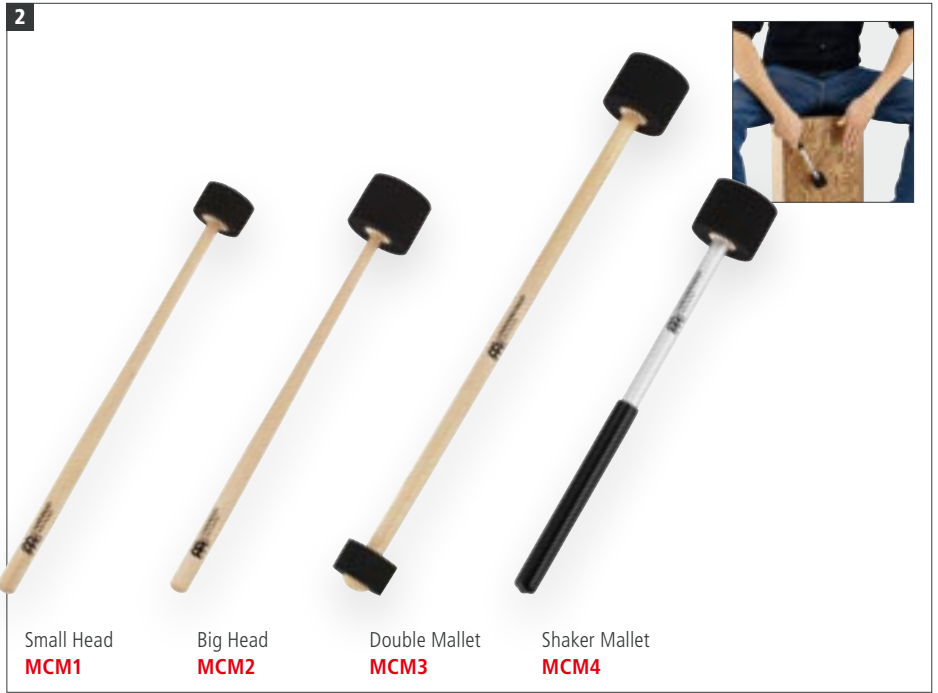

1 BASS BEAT CAJON BRUSH

SIZE 13" long
MATERIALS Polymer bristles
Foam rubber
FEATURES Straight polymer bristles for ultra-smooth precision; Soft foam rubber for full-bodied low notes; Two adjustable control rings; Flexible handle

2 CAJON MALLET COLLECTION

SIZES **MCM1, MCM4:** 11 3/4" long
MCM2: 12 1/4" long
MCM3: 15 1/2" long
MATERIALS Foam rubber
MCM1, MCM2, MCM3: Hard maple
MCM4: Aluminum
FEATURES Made in Germany
MCM1: Made out of the finest hand-selected maple; Small foam rubber head; Designed for softer playing
MCM2: Made out of the finest hand-selected maple; Extra thick foam rubber head
MCM3: Made out of the finest hand-selected maple; Foam rubber padding; Two different ends for contrasting sounds
MCM4: Integrated shaker effect in handle; Soft foam rubber head; Lightweight aluminum handle

3 TAMBORIM STICKS

MATERIAL Synthetic
COLOURS **BK:** Black
R: Red

4 BODHRAN TIPPERS

MATERIAL Ash Wood
COLOUR Antique Brown

5 SAMBA STICKS

SIZES **SST1-S:** Stick, short version
SST1-R: Stick, medium version
SST1-L: Stick, long version
SST3-S: Triple stick, short version
SST3: Triple stick
SST7: Sevenfold stick
MATERIAL Synthetic

6

Big felt head, medium hard
MPM1

Small felt head, hard
MPM2

Small rubber head, hard
MPM3

Small rubber head, soft
MPM4

7 **NEW**

American Hickory
MPM5

8 **EASY MOUNTABLE**

HAM1BK

9

Siam Oak
COW1

Molded ABS
COW3BK

Siam Oak
COW1BK

Siam Oak
COW2

PADDED BEATER SECTION

10

2" felt beater
SB1

2" felt beater
SB2

2 1/2" felt beater
SB3

2" leather beater
SB4

3" bushy felt beater
SB5

11

SBH

12

Mahogany Wood
SPARE-23

13

Wood
MGS1

ABS
MGS2

6 PERCUSSION MALLETS
 SIZE 12 1/2" long
 MATERIALS Hard maple
MPM1: Big felt head, medium hard
MPM2: Small felt head, hard
MPM3: Small rubber head, hard
MPM4: Small rubber head, soft
 FEATURES Made out of the finest hand-selected maple; Great for woodblocks and synthetic percussion blocks; Made in Germany

7 TEMPLE & WOOD BLOCK MALLETS
 SIZE 12 1/2" long
 MATERIAL American Hickory
 FEATURES Soft rubber mallet heads for wood blocks; Solid hickory handles

8 HANDMATE
 MATERIAL Steel construction with a wooden ball
 FEATURE Fully adjustable

9 COWBELL BEATERS
 MATERIALS **COW1, COW2:** Siam Oak (*Hevea brasiliensis* Muell.-Arg.)
COW3: Molded ABS
 FEATURES Ribbed grip; Durable construction

10 SAMBA BEATERS
 SIZES **SB1:** 15" long
SB2, SB3, SB4, SB5: 16" long
 MATERIALS **SB1:** Aluminum stick with 2" felt beater
SB2: Wood stick with 2" felt beater
SB3: Wood stick with 2 1/2" felt beater
SB4: Wood stick with 2" leather beater
SB5: Wood stick with 3" bushy felt beater

11 SURDO BEATER HOLDER
 MATERIAL Leather
 COLOUR Black

12 TALKING DRUM BEATER
 MATERIAL Mahogany Wood

13 GÜIRA SCRAPERS
 MATERIALS Steel rods
MGS1: Ergonomic wooden grip
MGS2: Sanded ABS grip

STANDS

1



Black powder coated



Chrome plated



Gold tone

Black powder coated

For Marathon® Classic Series
For Marathon® Designer Series
For Luis Conte Artist Series
ST-MCC11BK: 11"
ST-MCC1134BK: 11 3/4"
ST-MCC1212BK: 12 1/2"

Chrome plated

For Marathon® Exclusive Series
ST-MEC11CH: 11"
ST-MEC1134CH: 11 3/4"
ST-MEC1212CH: 12 1/2"
For Professional Series
For Fibercraft Series
ST-MP11CH: 11"
ST-MP1134CH: 11 3/4"
ST-MP1212CH: 12 1/2"
For Floatune Series
ST-FL10CH: 10"
ST-FL11CH: 11"
ST-FL12CH: 12"
ST-FL13CH: 13"
For Woodcraft Series
ST-WC11CH: 11"
ST-WC1134CH: 11 3/4"
ST-WC1212CH: 12 1/2"

Gold tone

For Marathon® Exclusive Series
ST-MEC11G: 11"
ST-MEC1134G: 11 3/4"
ST-MEC1212G: 12 1/2"
For Mongo Santamaria Artist Series
ST-MSA11G: 11"
ST-MSA1134G: 11 3/4"
ST-MSA1212G: 12 1/2"

**QUICK AND EASY HEIGHT
ADJUSTABILITY (DE PATENT)**

2

EASY HEIGHT EXTENSION

Black powder coated
ST-HEBK

Chrome plated
ST-HECH

Gold tone
ST-HEG



3



MIN. 43"
MAX. 52 3/4"

For Headliner® congas
HDSTAND

For MCC congas
TMDS

4



For HDSTAND and TMDS
THBM

**EASY
MOUNTABLE**

6



Chrome plated
MCH-CH

Gold tone
MCH-G

FOR ANY CONGA

5



Chrome plated
TMPDS

1 STEELY II CONGA STANDS (PATENTED)

MATERIAL Steel
FEATURES Metal spike attachment on each leg
L-shaped legs (DE, TH, US patent)
U-shaped notch for quick set up and breakdown (US patent)
Ergonomic arched rubber bracing for more stability (CN, DE, TH, US patent)
Notches for quick height adjustability (DE patent)
INCLUDES Hex key

2 STEELY II CONGA STAND HEIGHT EXPANDER SETS (DE PATENT)

MATERIAL Steel
FEATURE Easy and effective height extension
INCLUDES Mounting screws; Hex key
FINISHES **BK:** Black powder coated
CH: Chrome plated
G: Gold tone

3 CONGA DOUBLE STANDS

MATERIAL Steel
FEATURES Height adjustable
Double braced tripod legs
INCLUDES Hex key; Memory locks; Brackets; Set of screws, nuts, and washers; Mounting instructions

4 BONGO MOUNT

MATERIAL Chrome plated steel
FEATURES Easy mountable on our conga double stands HDSTAND and TMDS
Holds your bongo in place
Adjustable angle

5 PROFESSIONAL CONGA DOUBLE STAND WITH WHEELS

MATERIAL Chrome plated steel

FEATURES Height adjustable
Heavy construction
Double braced tripod legs
Lockable high-quality wheels
Padded separators for adjustable angle
Mounting instructions
INCLUDES Two mounting brackets

6 CONGA HANDLES

MATERIAL Steel
FEATURES Simple and safe add-on to help transport congas
Easily mountable with instructional guide
Fits any common conga
Leaves sound unaffected
INCLUDES Mounting screws and washers; Mounting instructions
FINISHES **CH:** Chrome plated
G: Gold tone

7 **STURDY LOCKABLE WHEELS MAKE IT EASY TO MOVE THE STAND INTO POSITION**

Chrome plated
TMPC

8 **THE LIGHTWEIGHT STAND CAN BE FOLDED TO A COMPACT UNIT WHICH REQUIRES LITTLE SPACE**

Chrome plated
TMC-CH

COMPATIBLE FOR ALL SIZES!

9

MIN. 34 1/2"
MAX. 50"

Black powder coated
THBS-BK

Chrome plated
THBS

AN INNOVATIVE BRACKET DESIGN ENABLES QUICK SET UP (PATENTED)

10 **PADDED T-SHAPED TUBE FOR MORE STABILITY**

MIN. 31 1/2"
MAX. 52 3/4"

Chrome plated
TMB

11 **A STABLE METAL CLAMP HOLDS THE ENTIRE UNIT IN PLACE**

MIN. 12 1/4"
MAX. 20"

Chrome plated
TMB-S

LOW HEIGHT FOR SEATED PLAYERS

12 **PERFECT HEIGHT FOR CAJON PLAYERS**

MIN. 22 3/4"
MAX. 29 1/2"

Black powder coated
THBS-S-BK

13 **DIFFERENT RODS FOR ALL NEEDS**

MIN. 31 1/2"
MAX. 52 1/2"

Chrome plated
TMPS

7 PROFESSIONAL CONGA STAND WITH WHEELS

- MATERIAL** Chrome plated steel
- FEATURES** Adjustable padded stops fit any conga size
Height adjustable legs
Lockable wheels

- FEATURES** Quick set up
Easy handling
Reliable placement
Double braced tripod stand
Fits all common bongos
- INCLUDES** Wrench
- FINISHES** **THBS:** Chrome plated
THBS-BK: Black powder coated

- FEATURES** Seated playing position possible
Padded T-shaped tube
Fully height and angle adjustable
Double braced tripod legs
Fits all common bongos
- INCLUDES** Hex key; Memory lock

8 PROFESSIONAL CONGA STAND

- MATERIAL** Chrome plated steel
- FEATURES** Unique design (DE patent)
Rubber padded crossbeams
Fully height adjustable
Folds up to a compact unit
- INCLUDES** Hex key; Memory locks

10 PROFESSIONAL BONGO STAND

- MATERIAL** Chrome plated steel
- FEATURES** Padded T-shaped tube
Fully height and angle adjustable
Double braced tripod legs
Fits all common bongos
- INCLUDES** Hex key; Memory locks

12 CAJON HEIGHT BONGO STAND

- MATERIAL** Black powder coated steel
- FEATURES** Quick set up
Easy handling
Perfect height for cajon players
Fits all common bongos

9 HEADLINER® SERIES BONGO STANDS (CN, DE, US PATENT)

- MATERIAL** Steel

11 PROFESSIONAL BONGO STAND FOR SEATED PLAYERS

- MATERIAL** Chrome plated steel

13 PERCUSSION STAND

- MATERIAL** Chrome plated steel
- FEATURES** Height adjustable
Double braced tripod legs
- INCLUDES** Hex key; Memory locks; 2 straight rods;
2 angled rods; 2 Z-shaped rods

STANDS

1 COLLAPSIBLE DESIGN



Black powder coated
STDJST-BK

2



QUICK AND EASY HEIGHT ADJUSTABILITY (DE PATENT)



Chrome plated
ST-DJEMBE

3 LENGTH ADJUSTABLE FOR VARIOUS DJEMBE SIZES



MIN. 23 1/2"
MAX. 37 3/4"



Chrome plated
TMD

4 FITS ALL CAJON SIZES



MIN. 26"
MAX. 40 1/2"

Black powder coated
TMCAJ

5



CMS

CAJON DRUM SET STANDS
(SEE PAGE 51)



CHS CCS CAS

6



MIN. 22"
MAX. 37"

Black powder coated
CPTS

7 SPECIAL LOW HEIGHT



MIN. 29 1/2"
MAX. 38"

Chrome plated
MLH

1 TRAVEL DJEMBE STAND

MATERIAL Black powder coated steel
FEATURES Collapsible design
Lightweight construction

2 STEELY II DJEMBE STAND (PATENTED)

MATERIAL Chrome plated steel
FEATURES Metal spike attached to each leg
L-shaped legs (DE, TH, US patent)
U-shaped notch for quick set up and breakdown (US patent)
Ergonomic arched rubber bracing for more stability (CN, DE, US patent)
Notches for quick height adjustability (DE patent)
Adapts to different djembe sizes
INCLUDES Hex key, 3 spacers

3 PROFESSIONAL DJEMBE STAND

MATERIAL Chrome plated steel
FEATURES Rubber padded hooks
Fully height and angle adjustable
Double braced tripod legs
INCLUDES Hex key; Memory lock

4 PROFESSIONAL CAJON STAND

MATERIAL Steel
FEATURES Quick set up
Fully height and angle adjustable
Double braced tripod stand
Fits all cajon sizes

5 CAJON MICROPHONE STAND

MATERIAL Black powder coated aluminum
FEATURES Round base for compact setup
Solid construction
Height adjustable

6 CAJON PICKUP TAPS STAND

MATERIAL Black powder coated aluminum
FEATURES Designed to mount the MEINL Cajon Pickup Tom and Snare Taps
Low-key stage footprint
L-Shaped 3/8" rod
Foldable legs, height adjustable

7 LOW HAT

MATERIAL Chrome plated steel
FEATURES Special low height
Made just for cajon players

8 TIMBALE STAND

MATERIAL Chrome plated steel
FEATURES Double braced tripod base
Height and angle adjustable
Standard mounting rod for auxiliary percussion



INCLUDES Accessory pouch; L-shaped tuning key; Tune Up Oil

9 PROFESSIONAL TIMBALE STAND

MATERIAL Chrome plated steel
FEATURES Heavy-duty double braced tripod base
Height and angle adjustable
Standard mounting rod for auxiliary percussion
INCLUDES Accessory pouch; L-shaped tuning key; Tune Up Oil

10 HAND-BALE STAND

MATERIAL Chrome plated steel
FEATURES Quick set up
Rubber-tipped three arm basket
Easy handling
Double braced tripod stand

11 PROFESSIONAL DOUMBЕК/IBO STAND

MATERIAL Chrome plated steel
FEATURES Foam padded ring
Fully height and angle adjustable
Double braced tripod legs
INCLUDES Hex key; Memory lock

12 DIDGERIDOO STAND

MATERIAL Black powder coated aluminum
FEATURES Steady support for your didgeridoo
Stable tripod base
Soft padding
Rubber yoke for added protection
FINISH Black

13 PROFESSIONAL DIDGERIDOO STAND

MATERIAL Black powder coated aluminum

FEATURES Dual leg base and strong aluminum construction
Protective rubber yoke and soft padding
Height and angle adjustable
FINISH Black

14 PRO DIDGERIDOO STAND

MATERIAL Chrome plated steel
FEATURES Play your didgeridoo in a seated or standing position
Accommodates most didgeridoo sizes and shapes
Padded rest with adjustable strap

15 CHIMES STAND

MATERIAL Chrome plated steel
FEATURES Full angle and height adjustability
Secure angle clamps
Telescoping stem

TABLES

1



20" x 12 1/2"
TMLTS



2

FABRIC ANTI-SLIP SURFACE



11" x 7"
MC-PTXS



12" x 12"
MC-PTS



18" x 12"
MC-PT

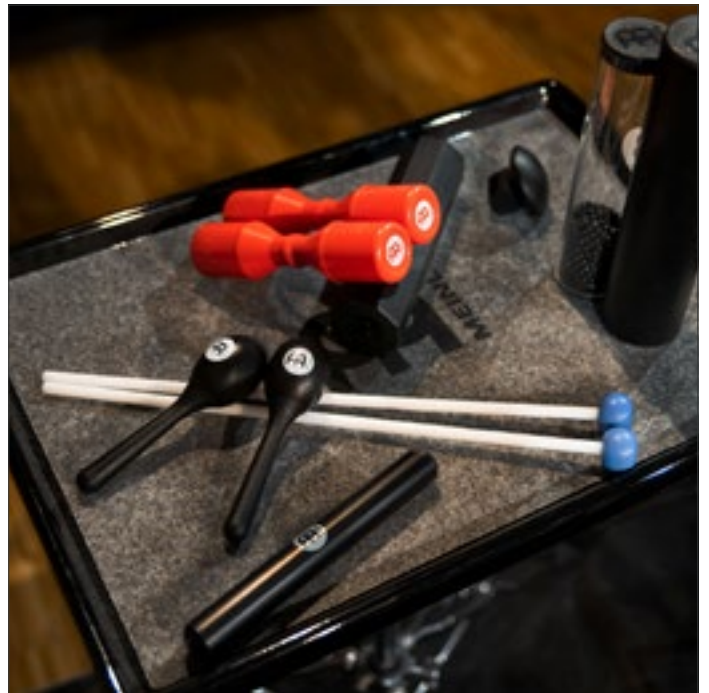

1 LAPTOP TABLE STAND

SIZE 20" x 12 1/2"
MATERIAL Perforated metal plate
FEATURES Holds laptops up to 17"
Stoppers and hook and loop fastener to secure the laptop
Holder for headphones
Cord strain relief

2 PERCUSSION TABLES

SIZES **MC-PT:** 18" x 12"
MC-PTS: 12" x 12"
MC-PTXS: 11" x 7"
MATERIALS **MC-PT, MC-PTS:** Premium fiberglass
MC-PTXS: Synthetic
FEATURES Fabric anti-slip surface
Adjustable angle
Strong mounting clamp

3

HEIGHT ADJUSTABILITY AT ALL POINTS



Black powder coated
TMPWS

4

ALL MEINL TRIPOD STANDS ARE EQUIPPED WITH MEMORY AND QUICK LOCKS

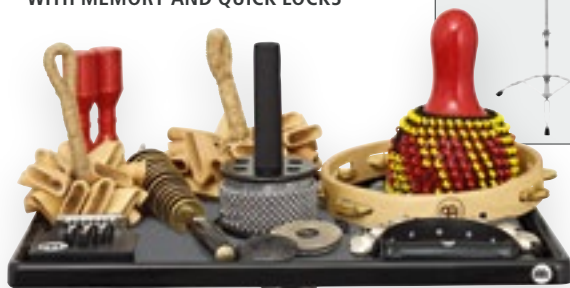

16" x 22"
TMPTS

MIN. 30"
MAX. 46 3/4"

5

ERGONOMIC SHAPE FOR MORE EFFICIENCY

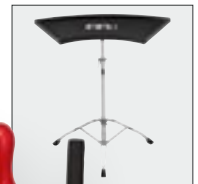

20" x 34"
TMPETS

MIN. 30"
MAX. 46 3/4"

3 PERCUSSION WORKSTATION

- MATERIAL** Black powder coated steel
- FEATURES** Fully height adjustable
Angle adjustable top bar
Heavy-duty construction
Infinitely expandable
Fabric anti-slip surfaces
Colour doesn't interfere with stage lighting
- INCLUDES** 1 x Padded fiberglass percussion table, 22" x 24"
2 x Padded fiberglass percussion tables, 18" x 12" (attachable)
1 x Vertical bar, 30"
2 x Vertical bars, 15" (attachable)
4 x Straight rods with hook
3 x Angled rods with hook
1 x Z-shaped rod with hook



4 PERCUSSION TABLE STAND

- SIZE** 16" x 22"
- MATERIALS** Table: Premium fiberglass
Stand: Chrome plated steel
- FEATURES** Fabric anti-slip surface
Fully height adjustable
Double braced tripod legs
- INCLUDES** Hex key
Memory lock

5 ERGO TABLE

- SIZE** 20" x 34"
- MATERIALS** Table: Premium fiberglass
Stand: Chrome plated steel
- FEATURES** Fabric anti-slip surface
Padded edge
Fully height adjustable
Ergonomic shape for more efficiency
Double braced tripod legs
- INCLUDES** Hex key
Memory lock

HARDWARE

<p>1 HOLDS TAMBOURINES AND SHAKERS</p>  <p>Mini Percussion Rack MC-SHTA</p>	<p>2 PADEDDED SURFACE</p>  <p>Tambourine Holder MC-TH</p>	<p>3</p> <p>MIN. 1" MAX. 6"</p>  <p>Shaker Holder MC-SH</p>	
<p>4</p> <p>MIN. 2 1/2" MAX. 3 3/4"</p>  <p>Güiro Holder MC-GU</p>	<p>5</p>  <p>Wood Block Holder MWBH1</p>	<p>6</p>  <p>Standard Frame Drum Holder MC-STFDH</p>	<p>7</p>  <p>Triangle Holder MC-TRI</p>
<p>8</p>  <p>Triangle Clamp CLAMP-TRI</p>	<p>9 FOR TURBO CABASA, MEDIUM</p>  <p>Cabasa Holder MC-CA</p>	<p>10</p>  <p>Frame Drum Holder MC-FDH</p>	
<p>11</p>  <p>Chimes Holders MC-CH MC-CHL</p>	<p>12</p>  <p>Drumstick Holders MC-DSH MC-DSH-JB</p>	<p>13</p>  <p>Bass Drum Cowbell Holders MC-STBD MC-BD</p>	

1 MINI PERCUSSION RACK

MATERIALS Black powder coated steel; Foam rubber
FEATURE Holds tambourines and shakers
COLOUR Black

2 TAMBOURINE HOLDER

MATERIAL Chrome plated steel
FEATURES Rubber pads; Padded surface

3 SHAKER HOLDER

MATERIAL Chrome plated steel
FEATURES Rubber pads; Length adjustable

4 GÜIRO HOLDER

MATERIAL Chrome plated steel
FEATURE Rubber pads

5 WOOD BLOCK HOLDER

MATERIAL Chrome plated steel

6 STANDARD FRAME DRUM HOLDER

MATERIAL Chrome plated steel
FEATURE Perfect for frame drums or traditional wood tambourines

7 TRIANGLE HOLDER

MATERIAL Chrome plated steel
FEATURES Knurled surface; Nylon cord

8 TRIANGLE CLAMP

MATERIAL Chrome plated steel
FEATURES Holds any triangle in place; Easy mountable

9 CABASA HOLDER

MATERIAL Chrome plated steel
FEATURES Strong mounting clamp; Padded surface

10 FRAME DRUM HOLDER

MATERIALS Chrome plated steel; Anodized aluminum
FEATURE Fully adjustable for any frame drum size

11 CHIMES HOLDERS

SIZES **MC-CH**: Regular
MC-CHL: Large
MATERIAL Chrome plated steel
FEATURES Knurled surface; Foam washer

12 DRUMSTICK HOLDERS

MATERIALS Chrome plated steel; Black textile pouch
FEATURE Strong mounting clamp
FINISHES **MC-DSH**: MEINL
MC-DSH-JB: Jawbreaker motif

13 BASS DRUM COWBELL HOLDERS

MATERIALS **MC-BD**: Chrome plated steel
MC-STBD: Black powder coated steel
FEATURES Rubber pads
MC-BD: Fully adjustable
INCLUDES **MC-BD**: L-shaped rod

14

Multi Clamp for Cymbal Stands
PMC-1

15

Pedal Mount
PM-1

16

Pedal Mount for Cymbals
PM-2

17

Cymbal Stackers
MC-CYS **MC-CYS8** **MC-CYS8-S**

18

MC-CY1
MC-CY2
MC-CY

Cymbal Holder Attachments

20

Cymbal Attachment
MCA

19

X-Hat Cymbal Stand Adapter
MXHA

21

NEW

Double Extension Arm
MDEA

22

X-Hat Auxiliary Hihat Arm
MXH

14 MULTI CLAMP FOR CYMBAL STANDS

MATERIAL Chrome plated steel
FEATURES Double-sided clamp; Attach a cymbal or tom arm to any stand; Universal for all standard drum hardware; Metal body with durable synthetic thumb screws

15 PEDAL MOUNT

MATERIAL Black powder coated steel
FEATURES Height adjustable legs; Metal spikes; Fits on all common bass drum pedals and firmly holds cowbells, blocks, or tambourines
INCLUDES 2 differently sized L-rods

16 PEDAL MOUNT FOR CYMBALS

MATERIAL Black powder coated steel
FEATURES For foot activated cymbal crashes; Holds cymbals ranging from 16" to 22"
INCLUDES Cymbal arm

17 CYMBAL STACKERS

SIZES **MC-CYS:** Ø 6 mm, long
MC-CYS8: Ø 8 mm, long
MC-CYS8-S: Ø 8 mm, short
MATERIAL Chrome plated steel
FEATURE Felt washers

18 CYMBAL HOLDER ATTACHMENTS

MATERIAL Chrome plated steel
FEATURES Knurled surface; Felt washers; For splashes or small crashes; Easy placement on a drumkit, cajon set or percussion rig
MC-CY: Z-shaped 3/8" rod
MC-CY1: S-shaped 3/8" rod
MC-CY2: Z-shaped 3/8" rod with extra-long knurled end

19 X-HAT CYMBAL STAND ADAPTER

MATERIAL Chrome plated steel
FEATURES Turn any cymbal stand into an X-Hat stand; Fits 8 mm threaded cymbal stand posts; Use with any size hihat or stack

20 CYMBAL ATTACHMENT

MATERIAL Chrome plated steel
FEATURES Multi-clamp; Cymbal boom arm

21 DOUBLE EXTENSION ARM

MATERIAL Chrome plated steel
FEATURES Two points of 360-degree adjustability; Heavy-duty chrome plated steel; Length adjustable

22 X-HAT AUXILIARY HIHAT ARM

MATERIAL Chrome plated steel
FEATURE Easy to attach and position at any height or angle

HARDWARE



Mic. Cymbal Clamp Set
MPMCS

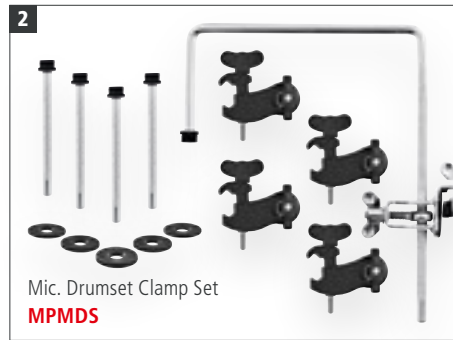

Mic. Drumset Clamp Set
MPMDS

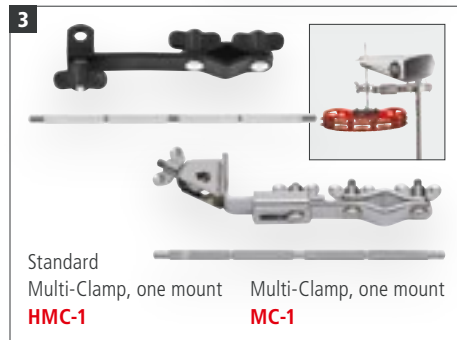

Standard Multi-Clamp, one mount
HMC-1 Multi-Clamp, one mount
MC-1



Multi-Clamp, two mounts
MC-2



Multi-Clamp, four mounts
MC-4

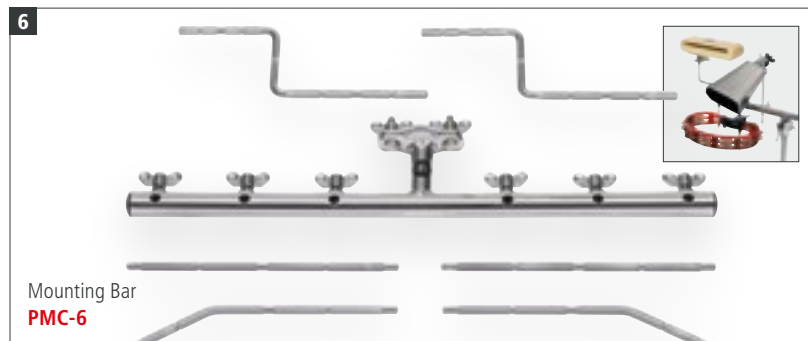

Mounting Bar
PMC-6

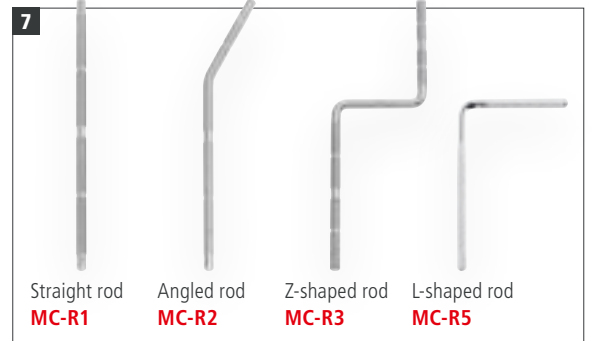

Straight rod
MC-R1 Angled rod
MC-R2 Z-shaped rod
MC-R3 L-shaped rod
MC-R5

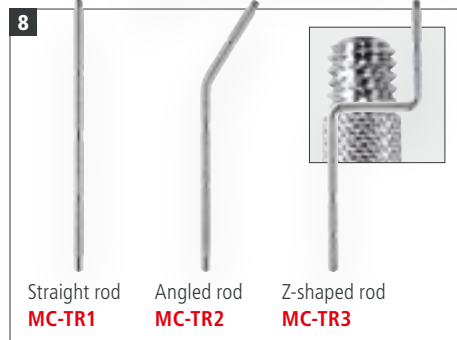

Straight rod
MC-TR1 Angled rod
MC-TR2 Z-shaped rod
MC-TR3

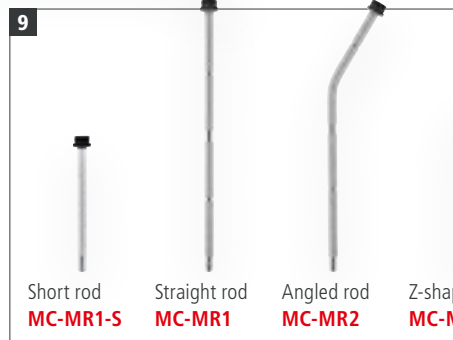

Short rod
MC-MR1-S Straight rod
MC-MR1 Angled rod
MC-MR2 Z-shaped rod
MC-MR3

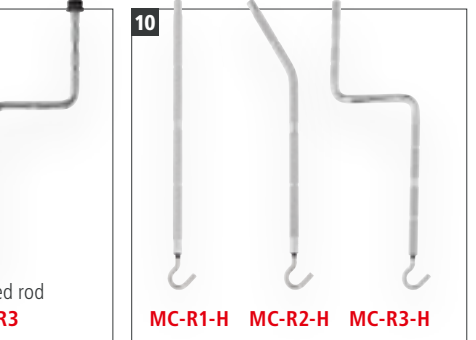

MC-R1-H **MC-R2-H** **MC-R3-H**

1 MICROPHONE CYMBAL CLAMP SET

CONTAINS 3 x Standard Multi-Clamp (HMC-1); 3 x Short Rod With Threaded Microphone Connector (MC-MR1-S); 1 x Microphone Rod Counter Nuts (MRCN5)

2 MICROPHONE DRUMSET CLAMP SET

CONTAINS 1 x Bass Drum Microphone Clamp (MC-MRBD); 4 x Rimclamp (RIMCLAMP-2); 4 x Short Rod With Threaded Microphone Connector (MC-MR1-S); 1 x Microphone Rod Counter Nuts (MRCN5)

3 MULTI-CLAMPS, ONE MOUNT

MATERIALS **HMC-1:** Black powder coated steel
MC-1: Chrome plated steel
FEATURES Strong mounting clamp
MC-1: Length adjustable
INCLUDES Straight rod

4 MULTI-CLAMP, TWO MOUNTS

MATERIAL Chrome plated steel
FEATURES Length adjustable; Strong mounting clamp
INCLUDES 2 straight rods

5 MULTI-CLAMP, FOUR MOUNTS

MATERIAL Chrome plated steel
FEATURES Length adjustable; Strong mounting clamp
INCLUDES 2 straight and 2 angled rods

6 MOUNTING BAR

MATERIAL Chrome plated steel
INCLUDES 2 straight, 2 angled and 2 z-shaped rods

7 RODS

MATERIAL Chrome plated steel
FEATURES Knurled surface; Available as a straight, angled, z-shaped, or l-shaped rod

8 THREADED PERCUSSION RODS

MATERIAL Chrome plated steel
FEATURE Threaded tip to mount any standard 3/8" threaded percussion instrument

9 RODS WITH THREADED MICROPHONE CONNECTOR

MATERIAL Chrome plated steel
FEATURES 3/8" diameter rod with threaded end; Designed to attach microphones; Use with the MEINL Rim Clamp; Available as a short, straight, angled, or z-shaped rod
INCLUDES Microphone screw adapter

10 RODS WITH HOOK

SHAPES **MC-R1-H:** Straight rod
MC-R2-H: Angled rod
MC-R3-H: Z-shaped rod
MATERIAL Chrome plated steel
FEATURES Knurled surface; Hook



11
Bass Drum
Microphone Clamp
MC-MRBD



12
Set, 5 pcs.
Microphone Rod Counter Nuts
MRCN5

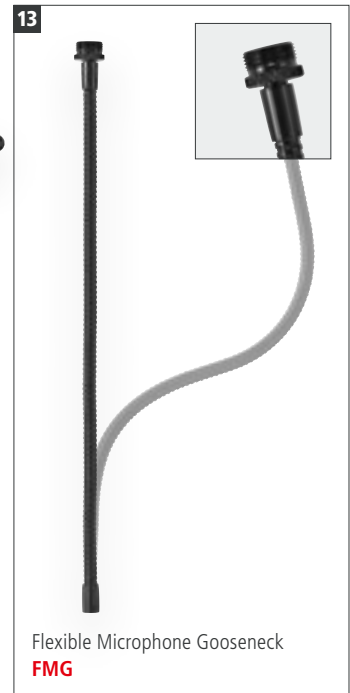

13
Flexible Microphone Gooseneck
FMG



14
Microphone
Cajon Clamp
MPMCC



15
Microphone
Adapter
TMMA



16
Clamp
CLAMP

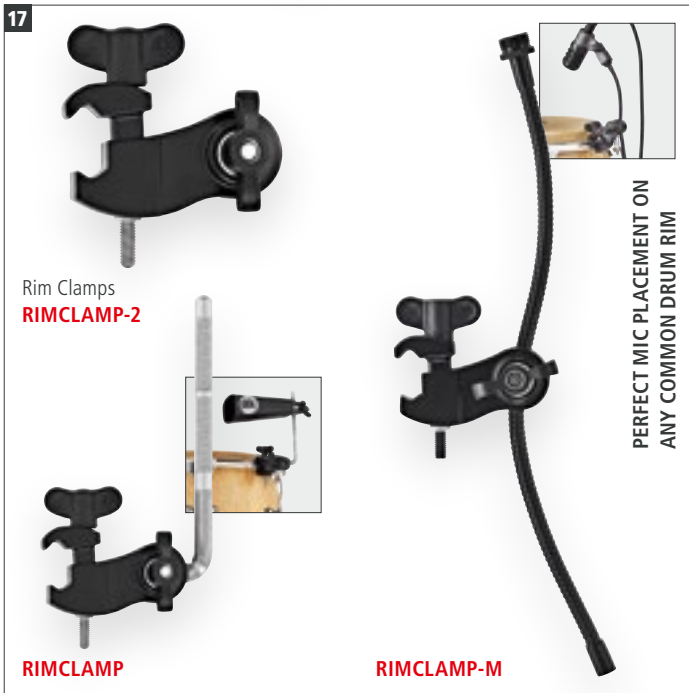

17
Rim Clamps
RIMCLAMP-2

RIMCLAMP

RIMCLAMP-M

PERFECT MIC PLACEMENT ON
ANY COMMON DRUM RIM

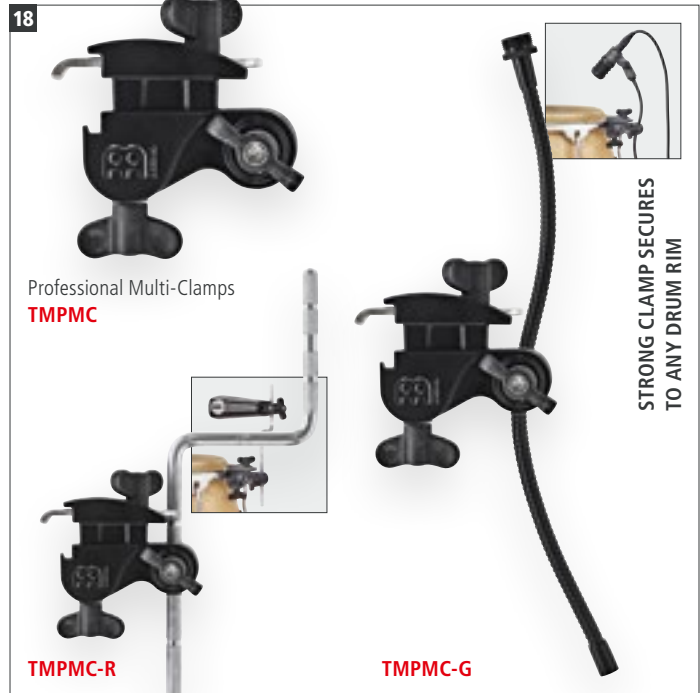

18
Professional Multi-Clamps
TMPMC

TMPMC-R

TMPMC-G

STRONG CLAMP SECURES
TO ANY DRUM RIM

11 BASS DRUM MICROPHONE CLAMP
MATERIAL Chrome plated steel
FEATURE U-shape 3/8" diameter rod with threaded end to attach a microphone

12 MICROPHONE ROD COUNTER NUTS
MATERIAL Black powder coated steel
FEATURES Set of 5 counter nuts; Securely lock your microphone attachments

13 FLEXIBLE MICROPHONE GOOSENECK
SIZE 12.8" (32.5 cm)
MATERIAL Metal
FEATURES Optimal microphone placement; No additional stand required; Fits in the MEINL Rim Clamp; 3/8" and 5/8" threads

14 MICROPHONE CAJON CLAMP
MATERIAL Steel
FEATURE Foam padding ensures quiet recording

15 MICROPHONE ADAPTER
MATERIAL Chrome plated steel
FEATURES Turns your cymbal stand into a microphone stand; 8 mm threaded attachment
INCLUDES 5/8" male to 3/8" mic screw adapter

16 CLAMP
MATERIAL Chrome plated steel
FEATURE Compact and solid design

17 RIM CLAMPS
MATERIALS Black powder coated steel
RIMCLAMP: Chrome plated steel (L-shaped rod)
RIMCLAMP-M: Metal (Gooseneck)
FEATURES Fully height and angle adjustable; Fits to any common drum rim
RIMCLAMP, RIMCLAMP-2: Holds percussion accessories right where you need them

INCLUDES
RIMCLAMP-M: Works with all 3/8" or 5/8" mic clips (Mic clip not included)
RIMCLAMP: L-shaped rod
RIMCLAMP-M: Flexible Microphone Gooseneck

18 PROFESSIONAL MULTI-CLAMPS
MATERIALS Black powder coated die cast steel
TMPMC-G: Metal (Gooseneck)
TMPMC-R: Chrome plated steel (Z-shaped rod)
FEATURES 360-degree adjustable 3/8" rod eye bolt mount
TMPMC: Strong clamp secures to any drum set or percussion rim
TMPMC-G: Removable flexible microphone gooseneck; Strong clamp secures to any drum set or percussion rim
TMPMC-R: Removable Z-shaped 3/8" rod to mount percussion instruments

BAGS



BAGS

MATERIAL Heavy-duty nylon
(unless noted otherwise)

1 CAJON GIG BAG

SIZE 20 1/2" W x 12" H x 12" D

FEATURE Carrying grip

2 PROFESSIONAL CAJON BAGS

SIZES **MCJB, MCJB-CG:**

20 1/2" W x 12" H x 12" D

MCJB-L: 23 1/2" W x 17" H x 15" D

MATERIAL **MCJB-CG:** Ripstop Fabric

FEATURES Padded shoulder strap; External pocket;
Carrying grip

MCJB-L: Fits bigger sized cajons

FINISH **MCJB-CG:** Carbon Grey

3 DELUXE CAJON BAG

SIZE 20 1/2" W x 12" H x 12" D

FEATURES Synthetic fur; Padded shoulder strap;
External pocket; Carrying grip

4 DELUXE BASS PEDAL CAJON BAG

SIZE 21 1/2" W x 17" H x 14 1/2" D

FEATURES Synthetic fur; Padded shoulder strap;
External pocket; Carrying grip

5 PROTECTION COVER FOR HEADLINER® CAJONS

FEATURE Fits all HCAJ1 models

6 CAJON BACKPACK

SIZE 13 1/2" W x 19 3/4" H x 14" D

FEATURES Backpack; Carrying grip

7 CAJON BACKPACK PRO

SIZE 12" W x 20 1/2" H x 12" D

MATERIAL Ripstop Fabric

FEATURES Padded backpack shoulder straps;
External pocket; Carrying grip

FINISH Carbon Grey

8 JAM CAJON GIG BAG

SIZE 12" W x 16" H x 12" D

FEATURES Fits all Jam Cajon models;
Strong carrying grip; Two-way zipper

9 PROFESSIONAL SLAPTOP CAJON BAG

SIZE 23" W x 15" H x 13" D

FEATURES Padded shoulder strap; External pocket;
Carrying grip



MULTI-PERCUSSION BAG

MCPB



DELUXE DJEMBE BAGS

MDLXDJB-M

MDLXDJB-L



STANDARD DJEMBE BAGS

MSTDJB10

MSTDJB12



PRO DJEMBE BAGS

MDJB-S

MDJB-M

MDJB-L

MDJB-XL



DJEMBE GIG BAG

MSTDJB



PRO DJEMBE CAPS

DCAP-M

DCAP-L

DCAP-XL



CONGA GIG BAG

MSTCOB



PRO CONGA BAGS

MCOB-11

MCOB-1134

MCOB-1212



PRO PANDEIRO BAGS

MPAB-10

MPAB-12



TAMBOURINE GIG BAG

MSTTB

10 PROFESSIONAL HYBRID SLAPTOP CAJON BAG

SIZE 17 1/2" W x 13" H x 8" D
FEATURES Padded shoulder strap; Carrying grip

11 TRAVEL CAJON GIG BAG

SIZE 12"
FEATURES Double-slide zipper; Carrying grip

12 MULTI-PERCUSSION BAG

SIZE 21" W x 12" H x 15" D
FEATURES Padded shoulder strap; External pocket; Carrying grip; Padded dividers

13 DELUXE DJEMBE BAGS

SIZES **M**: Medium (up to 12")
L: Large (up to 13 1/2")
FEATURES Synthetic fur; External pocket; Padded backpack straps; Carrying grip

14 STANDARD DJEMBE BAGS

SIZES **MSTDJB10**: Medium (10")
MSTDJB12: Large (12")
FEATURES External pocket; Carrying grip

15 PROFESSIONAL DJEMBE BAGS

SIZES **S**: Small (up to 10")
M: Medium (up to 12")
L: Large (up to 13 1/2")
XL: XL: Extra large (up to 14")
FEATURES External pocket; Carrying grip
MDJB-M, MDJB-L, MDJB-XL: Padded backpack straps

16 DJEMBE GIG BAG

FEATURES Carrying grip; Shoulder strap; Outer pocket

17 PROFESSIONAL DJEMBE CAPS

SIZES **M**: 10"; **L**: 12"; **XL**: 13"

18 CONGA GIG BAG

FEATURES Carrying grip; Shoulder strap; Outer pocket

19 PROFESSIONAL CONGA BAGS

SIZES **MCOB-11**: 11"
MCOB-1134: 11 3/4"
MCOB-1212: 12 1/2"
FEATURES Additional upright zipper; External pocket; Padded backpack straps; Carrying grip

20 PROFESSIONAL PANDEIRO BAGS

SIZES **MPAB-10**: 10"; **MPAB-12**: 12"
FEATURES Double-slide zipper; Shoulder strap; External pocket
MPAB-12: Also fits for our 10" Tambourines

21 TAMBOURINE GIG BAG

SIZE 10"
FEATURES Sturdy zipper; Carrying grip

BAGS



BAGS

MATERIAL Heavy-duty nylon
(unless noted otherwise)

1 BONGO GIG BAG

SIZE Bongos up to 7 1/2" Macho & 8 1/2" Hembra
FEATURE Carrying grip

2 PROFESSIONAL BONGO BAG

FEATURES Additional room for accessories; Padded shoulder strap; Carrying grip; Padded separator

3 PROFESSIONAL TIMBALES BAG

SIZE 14" & 15"
FEATURES External pocket for stand and cowbell; Padded shoulder strap; Carrying grip; Padded separator

4 PROFESSIONAL SURDO BAGS

SIZES **MSUB-16:** 16" x 20"
MSUB-18: 18" x 22"
MSUB-20: 20" x 24"
MSUB-22: 22" x 24"

FEATURES Double-slide zipper; Padded backpack straps; Carrying grip; External pocket

5 PROFESSIONAL TIMBA BAGS

SIZES **MTIMB-1428:** 14" x 28"
MTIMB-1435: 14" x 35"

FEATURES Double-slide zipper; Padded backpack straps; Carrying grip; External pocket

6 PROFESSIONAL TANTAM BAG

SIZE 14" x 28"
FEATURES Double-slide zipper; Padded backpack straps; Carrying grip; External pocket

7 PROFESSIONAL REBOLO BAG

SIZE 12" x 18"
FEATURES Double-slide zipper; Padded shoulder strap; Carrying grip; External pocket

8 PROFESSIONAL REPINIQUE BAGS

SIZES **MREB-10:** 10" x 10"
MREB-12: 12" x 12"
FEATURES Double-slide zipper; Shoulder strap; Carrying grip; External pocket

9 PROFESSIONAL TAMBORIM BAG

SIZE 6"
FEATURES Double-slide zipper; Shoulder strap; External pocket



PRO CUIXA BAGS

MQW-6 MQW-7 MQW-10



PRO CAIXA BAGS

MCA-12 MCA-12T MCA-14



PRO CHIMES BAG

MCHB



PRO FRAME DRUM BAGS

MFDB-14 MFDB-16 MFDB-18 MFDB-20 MFDB-22



PRO DEEP SHELL FRAME DRUM BAGS

MFDB-12BE MFDB-14BE MFDB-14IBO MFDB-18BO MFDB-22-D



PRO KANJIRA BAG

MFDB-7KA

10 PROFESSIONAL CUIXA BAGS

SIZES MQW-6: 6"
MQW-7: 8"
MQW-10: 10"

FEATURES Padded shoulder strap; Carrying grip; External pocket

11 PROFESSIONAL CAIXA BAGS

SIZES MCA-12: 12" x 4 1/2"
MCA-12T: 12" x 6"
MCA-14: 14" x 4"

FEATURES Double-slide zipper; Shoulder strap; Extra pocket for spare heads; Carrying grip; External pocket

12 PROFESSIONAL CHIMES BAG

FEATURES Stores up to 2 chimes; Carrying grip; Inner hook and loop fastener straps; 2 internal pockets

13 PROFESSIONAL FRAME DRUM BAGS

SIZES MFDB-14: 14", 2 1/2" deep
MFDB-16: 16", 2 1/2" deep
MFDB-18: 18", 2 1/2" deep
MFDB-20: 20", 2 1/2" deep
MFDB-22: 22", 2 1/2" deep

FEATURES Double-slide zipper; Shoulder strap; Carrying grip

14 PROFESSIONAL DEEP SHELL FRAME DRUM BAGS

SIZES MFDB-12BE: 12" x 4"
MFDB-14BE: 14" x 4"
MFDB-14IBO: 14" x 6"
MFDB-18BO: 18" x 4"
MFDB-22-D: 22" x 4"

FEATURES Double-slide zipper; Shoulder strap; Carrying grip

15 PROFESSIONAL KANJIRA BAG

SIZE 8 1/2" x 2 1/2"

FEATURES Double-slide zipper; Shoulder strap; External pocket

BAGS



BAGS

MATERIAL Heavy-duty nylon
(unless noted otherwise)

1 STANDARD DARBUKA BAG

SIZE Medium
FEATURES Carrying grip; Shoulder strap; Outer pocket

2 PROFESSIONAL DARBUKA BAG

FEATURES Double-slide zipper; Additional upright zipper; Padded shoulder strap; Carrying grip; External pocket

3 PROFESSIONAL IBO BAGS

SIZES **S:** Small (9 3/4" W x 13 1/3" H x 9 3/4" D)
M: Medium (11" W x 14 1/2" H x 11" D)
L: Large (11 3/4" W x 15" H x 11 3/4" D)
FEATURES Padded shoulder strap; Carrying grip; External pocket

4 STANDARD DOUMBЕК BAG

SIZE Medium
FEATURES Carrying grip; Shoulder strap; Outer pocket

5 PROFESSIONAL DOUMBЕК BAGS

SIZES **MDOB:** Medium
MDOB-L: Large
FEATURES Double-slide zipper; Additional upright zipper; Padded shoulder strap; Carrying grip; External pocket

6 STRAIGHT DIDGERIDOO BAG

SIZE 53"
FEATURES Padded shoulder strap; External pocket

7 PRO DIDGERIDOO BAG

SIZE 58"
FEATURES Padded shoulder strap; External pocket

8 PERCUSSION BACKPACK

MATERIAL Ripstop Fabric
FEATURES Travel backpack for small percussion instruments; Numerous pockets on the inside and outside; Padded backpack shoulder straps; Carrying grip
FINISH Carbon Grey

9 HAND PERCUSSION BAGS

SIZES **M:** Medium
L: Large
FEATURES Great for cowbells, blocks or small hand percussion; Drawstring top; Durable nylon prevents scuffs and scratches; No hassle storage or travel

10 COMPACT STICK BAG

FEATURE Carrying grip

BAGS & DRUM RUGS



COMPACT STICK BAG

MCSB



PROFESSIONAL STICK BAG

MSB-1

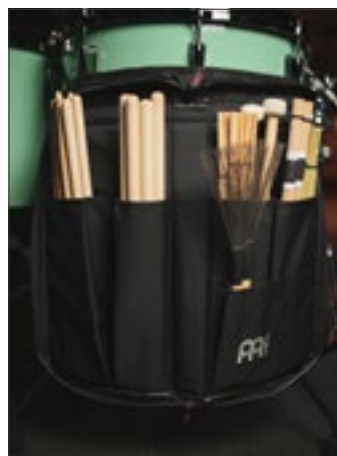

DELUXE STICK BAG

MDLXSB



STICK SLING BAG

MSSB



DRUM RUG



JUAN CARLOS MELJAN, SPAIN

Black, small
MDRS-BK

Black, large
MDRL-BK

Oriental, small
MDRS-OR

Oriental, large
MDRL-OR

11 PROFESSIONAL STICK BAG

FEATURES External pockets; Shoulder straps; Extension straps
COLOUR Black

12 DELUXE STICK BAG

MATERIAL Padded synthetic leather
FEATURES External pockets; Shoulder straps; Elastic cord attachments

13 STICK SLING BAG

FEATURES Wider version of our Professional Stick Bag; Eleven internal pockets of varying size for any kind of stick, mallet, rod, brush or accessory; Oversized exterior pocket that can fit books, sheet music, practice pads or metronomes

14 DRUM RUGS

SIZES **MDRS:** 5.25 ft (160 cm) x 4.6 ft (140 cm)
MDRL: 6.5 ft (200 cm) x 6.5 ft (200 cm)

MATERIAL Woven fabric

FEATURES **MDRS**

Tightly woven fabric creates a strong grip with spurs and stands; Durable no-slip rubber bottom; Compact size for smaller drum or percussion setups; Ideal for smaller stage footprint

MDRL

Durable no-slip rubber bottom; Full-size for any drum or percussion setup; Ideal for drum risers

INCLUDES Travel bag
Strap

FINISHES **BK:** Black
OR: Oriental



Music is an essential part of early childhood development

Learning an instrument means learning for life. Making music in kindergarten, or at home at an early age, makes it easier for children to learn a new instrument later on. NINO® Percussion gives children the possibility to make their first contact with musical instruments, starting at an early age of 3 years.

Early childhood development includes encouraging children to live out their natural musicality. Playing an instrument helps them to gain a bunch of new skills, such as hand-eye coordination, fine and gross motor control, concentration, and of course a sense of rhythm.



NINO® Percussion specialized on rhythm, shaker, and classroom sets for musical programmes in kindergarten, schools, and other educational institutions. Those sets are flexibly combinable. The coloured buttons allow you to learn about the group size per set:

Small groups: max. 6 kids

Medium-sized groups: max. 16 kids

Large groups: more than 16 kids

NINO® Percussion hand percussion, drum circle and sound instruments are instruments for the whole family. They look good in the living or the children's room, are easy to storage, and most of them can be space-sparingly taken on a family trip. Nowadays, there are tons of good books and tutorials, that allow parents to easily learn an instrument with their children.

NINO sets	114-119
Shaker sets	114
Rhythm sets	116
Classroom sets	118
NINO instruments	120-135
Hand percussion	120
Drum circle instruments	128
Sound instruments	134
Accessories	136-137

SHAKER SETS



Set, 3 pcs.
NINO507

Set, 3 pcs.
NINO508

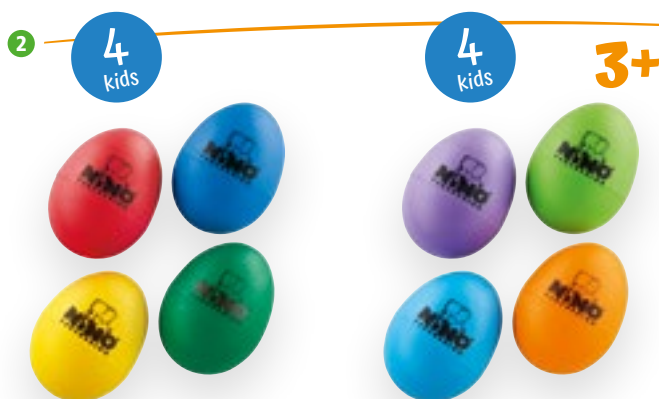

Set, 4 pcs.
NINOSET540

Set, 4 pcs.
NINOSET540-2



Set, 80 pcs.
VE80-NINO540



Set, 80 pcs.
VE80-NI540-2



Set, 4 pcs.
NINOSET100



Set, 18 pcs.
NINOSET536

1 WOOD SHAKER SETS, 3 PCS.

SHAPES NINO507: Square
NINO508: Triangular
MATERIAL Siam Oak (*Hevea brasiliensis* Muell.-Arg.)
FEATURE Different sounding fillings

2 EGG SHAKER SETS, 4 PCS.

MATERIAL Synthetic
CONTAINS NINOSET540
Egg Shaker, 4 pcs. (blue, green, red, yellow)
NINOSET540-2
Egg Shaker, 4 pcs. (aubergine, grass green, orange, sky blue)

3 EGG SHAKER ASSORTMENTS, 80 PCS.

MATERIAL Synthetic
CONTAINS VE80-NINO540
Egg Shaker, 25 pcs. (black)
Egg Shaker, 15 pcs. (blue)
Egg Shaker, 10 pcs. (orange)
Egg Shaker, 15 pcs. (red)
Egg Shaker, 15 pcs. (yellow)
VE80-NI540-2
Egg Shaker, 10 pcs. (aubergine)
Egg Shaker, 10 pcs. (black)
Egg Shaker, 10 pcs. (grass green)
Egg Shaker, 10 pcs. (orange)
Egg Shaker, 10 pcs. (red)
Egg Shaker, 10 pcs. (sky blue)
Egg Shaker, 10 pcs. (strawberry pink)
Egg Shaker, 10 pcs. (yellow)
INCLUDES One elephant shaped rattan basket

4 "FRUIT" SHAKER SET, 4 PCS.

MATERIAL Synthetic
CONTAINS "Apple" Shaker, 1 pc.
"Banana" Shaker, 1 pc.
"Lemon" Shaker, 1 pc.
"Orange" Shaker, 1 pc.

5 "FRUIT" SHAKER ASSORTMENT, 18 PCS.

MATERIAL Synthetic
CONTAINS "Banana" Shaker, 4 pcs.
"Apple" Shaker, 4 pcs.
"Orange" Shaker, 4 pcs.
"Lemon" Shaker, 4 pcs.
"Pineapple" Shaker, 2 pcs.
INCLUDES One rattan basket



6 2-4 kids



3+

Shake the pieces and find a pair that sounds the same! The photos on the bottom show you if they are correct.

NINO526

7 7 kids

NEW

3+



Set, 7 pcs.
NINOSSET13

8 4 kids

NEW

3+



Set, 4 pcs.
NINOSSET569

9 48 kids

3+



Set, 48 pcs.
VE48-NINO569

6 SHAKE 'N PLAY, 16 PCS.

MATERIALS Synthetic shakers
Siam Oak baseplate
(*Hevea brasiliensis* Muell.-Arg.)

CONTAINS 16 shakers (8 pairs)
Wooden baseplate
Game guide (in 8 languages)

COLOUR Orange

7 MIXED SHAKER SET, 7 PCS.

MATERIAL Synthetic
CONTAINS Egg Shaker, 2 pcs. (blue, green)
Egg Maraca, 2 pcs. (orange, red)
"Banana" Shaker, 1 pc.
"Salt & Pepper" Shakers, 2 pcs.

8 MARACAS SHAKER SET, 4 PCS.

MATERIAL Synthetic
CONTAINS Egg Maraca, 4 pcs.
(sky blue, grass green, orange, red)

9 MARACAS SHAKER ASSORTMENT, 48 PCS.

MATERIAL Synthetic
CONTAINS Egg Maraca, 12 pcs. (grass green)
Egg Maraca, 12 pcs. (orange)
Egg Maraca, 12 pcs. (red)
Egg Maraca, 12 pcs. (sky blue)
INCLUDES One rattan basket

RHYTHM SETS

1 **4**
kids



Set, 4 pcs.
NINOSET2

3+

4
kids

NEW

3+



Set, 5 pcs.
NINOSET7

5
kids

3+



Set, 5 pcs.
NINOSET3

5
kids

NEW

3+



Set, 5 pcs.
NINOSET8

5
kids

3+



Set, 5 pcs.
NINOSET1

8
kids

3+



Set, 8 pcs.
NINOSET4

1 MIXED RHYTHM SETS

- CONTAINS** **NINOSET1**
ABS Hand Drum 6", 1 pc. (red)
Jingle Stick, 1 pc. (red)
Wood Shaker, large, 1 pc.
Skin Maraca, small, 2 pcs.
- NINOSET2**
Jingle Stick, 1 pc. (red)
Wood Claves pair, small (natural)
Egg Shaker, 2 pcs. (blue, yellow)
- NINOSET3**
ABS Hand Drum 6", 1 pc. (blue)
Jingle Stick, 1 pc. (red)
Wood Claves pair, small (natural)
Egg Shaker, 2 pcs. (green, yellow)

NINOSET4

- Wood Güiro, 1 pc.
Caxixi, 1 pc.
Wood Claves pair, small (natural)
Triangle, small, 1 pc.
Egg Shaker, 2 pcs. (black, blue)
"Banana" Shaker, 1 pc.
"Apple" Shaker, 1 pc.
- NINOSET7**
Egg Shaker, 2 pcs. (sky blue, grass green)
"Banana" Shaker, 1 pc.
- NINOSET8**
ABS Hand Drum 6", 1 pc. (strawberry pink)
Egg Shaker, 2 pcs. (orange, grass green)
"Banana" Shaker, 1 pc.
Energy Chime, small, 1 pc.

INCLUDES **NINOSET1, NINOSET4:** Harlekin bag

2 RHYTHM ASSORTMENT, 12 PCS.

- CONTAINS** **NINOSET012, NINOSET012-WB**
Headed ABS Tambourine 10", 1 pc. (red)
ABS Hand Drum 12", 1 pc. (sky blue)
ABS Hand Drum 8", 1 pc. (grass green)
ABS Hand Drum 6", 1 pc. (yellow)
Jingle Stick, 1 pc. (yellow)
Jingle Stick, 1 pc. (red)
Skin Maracas, small, 2 pcs.
Wood Block, large, 1 pc.
Skin Egg Shaker, 1 pc.
Wood Tambourine 10", 1 pc.
Wood Shaker, small, 1 pc.
- INCLUDES** **NINOSET012-WB:** Wooden Box



Set, 12 pcs.
NINOSSET012



Set, 15 pcs.
NINOSSET515



Set, 12 pcs.
NINOSSET012-WB



Set, 15 pcs.
NINOSSET515-WB



Set, 12 pcs.
NINOSSET9



Set, 5 pcs.
NINOSSET6



Set, 6 pairs
NINOS502-MC

3 RHYTHM ASSORTMENT, 15 PCS.

CONTAINS **NINOSSET515, NINOSSET515-WB**

- Wood Güiro, 1 pc.
- Triangle, medium, 1 pc.
- Egg Maracas, 2 pcs. (red)
- Mini Güiro, 1 pc. (red)
- Egg Shaker, 1 pc. (yellow)
- Racket Wood Tambourine, 1 pc.
- Wood Claves pair, small
- Energy Chime, medium, 1 pc.
- Wood A-Go-Go, 2 rows, 1 pc.
- Double Shaker, 1 pc.
- Wood Shaker Set, 3 pcs. (Triangular)
- "Banana" Shaker, 1 pc.

INCLUDES **NINOSSET515**: One rattan basket
NINOSSET515-WB: Wooden Box

4 MIXED RHYTHM SET, 12 PCS.

- CONTAINS Egg Shaker, 4 pcs. (aubergine, yellow, sky blue, grass green)
Egg Maracas, 4 pcs. (sky blue, grass green, orange, red)
ABS Hand Drum 8", 1 pc. (grass green)
ABS Hand Drum 12", 1 pc. (sky blue)
Headed ABS Tambourine 10", 1 pc. (red)
ABS Tambourine 8", 1 pc. (yellow)
- INCLUDES Wooden beaters, 3 pcs.

5 HAND DRUM SET, 4 PCS.

- CONTAINS ABS Hand Drum 6", 1 pc. (yellow)
ABS Hand Drum 8", 1 pc. (sky blue)
ABS Hand Drum 10", 1 pc. (grass green)
ABS Hand Drum 12", 1 pc. (red)
- INCLUDES Wooden beaters
One red nylon bag

6 MULTI-COLOURED CLAVE PACK

- SIZE Small
MATERIAL Siam Oak (*Hevea brasiliensis* Muell.-Arg.)
CONTAINS 12 Claves (6 pairs)
COLOURS Natural, orange, red, green, blue

CLASSROOM SETS

1 7 players



NEW

4+

Set, 7 pcs.
NINOSSET950

2 6 kids



3+



Set, 6 pcs.
NINOSSET931

NEW

3 8 kids



3+

4 8 kids

3+



NEW

NEW

Set, 10 pcs.
NINOSSET954

Set, 18 pcs.
NINOSSET954-2

1 CLASSROOM CAJON GROUP RHYTHM SET, 7 PCS.

CONTAINS Cajon, small, 6 pcs. (kids)
Cajon, 1 pc. (adult)
COLOURS Natural, green, blue, red, orange, yellow

2 CLASSROOM BONGO CAJON GROUP RHYTHM SET, 6 PCS.

CONTAINS Bongo Cajon, 6 pcs.
COLOURS Natural, green, blue, red, orange, yellow

3 CLASSROOM CAJON GROUP RHYTHM SET

CONTAINS Classroom Cajon, 8 instruments – 1 pc.
Wooden Classroom Cajon Stand
Wooden stools
COLOURS Classroom Cajon and stools: Natural, green, blue, red, orange, yellow

4 DELUXE CLASSROOM CAJON GROUP RHYTHM SET

CONTAINS Deluxe Classroom Cajon, 8 separate instruments
Wooden baseplate
Wooden stools
COLOURS Classroom Cajon and stools: Natural, green, blue, red, orange, yellow

5

6
kids

3+



NEW

Set, 6 pcs.
NINOSETMDJ



6

4
kids

3+



Set, 11 pcs.
NINO966

5 CLASSROOM DJEMBE GROUP RHYTHM SET, 6 PCS.

CONTAINS Elements Mini Djembes, 6 pcs.
COLOURS Fire engine, tangerine, lemon, green apple, sea foam, grape

7

4
kids

3+



NEW

Set, 15 pcs.
NINOSET966

6 CLASSROOM HAND DRUM GROUP RHYTHM SET

CONTAINS ABS Hand Drum 6", 4 pcs.
ABS Hand Drum 8", 4 pcs.
ABS Hand Drum 12", 1 pc.
INCLUDES Wooden stand
Wooden baseplate
Wooden beaters, 8 pcs.
COLOUR Baseplate: Green

7 CLASSROOM HAND DRUM GROUP RHYTHM SET WITH STOOLS

CONTAINS ABS Hand Drum 6", 4 pcs.
ABS Hand Drum 8", 4 pcs.
ABS Hand Drum 12", 1 pc.
INCLUDES Wooden stand
Wooden baseplate
Wooden beaters, 8 pcs.
Wooden stools, 4 pcs.
COLOURS Baseplate: Green
Stools: Blue, red, orange, yellow

HAND PERCUSSION

1 ALSO AVAILABLE AS SETS



Lemon
NINO599



Orange
NINO598



Banana
NINO597



Apple
NINO596



Pineapple
NINO595

3+

2 ALSO AVAILABLE AS SETS



Sky Blue
NINO569SB



Grass Green
NINO569GG



Orange
NINO569OR

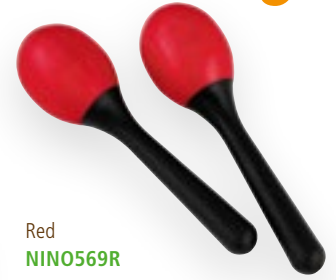

Red
NINO569R

3+

3



Green
NINO582GR



Yellow
NINO582Y



Red
NINO582R

3+

4



Set, 2 pcs.
NINO578

3+

5 ALSO AVAILABLE AS SETS



Aubergine
NINO540AU-2



Sky Blue
NINO540SB-2



Grass Green
NINO540GG-2



Yellow
NINO540Y-2



Orange
NINO540OR-2



Red
NINO540R-2



Strawberry Pink
NINO540SP-2



Black
NINO540BK-2

3+

1 "FRUIT" SHAKERS

MATERIAL Synthetic
FRUITS NINO595: "Pineapple" Shaker
NINO596: "Apple" Shaker
NINO597: "Banana" Shaker
NINO598: "Orange" Shaker
NINO599: "Lemon" Shaker

2 EGG MARACAS, PAIR

MATERIAL Synthetic
FEATURE Ergonomically shaped handle
COLOURS SB: Sky blue
OR: Orange
GG: Grass green
R: Red

3 MARACAS, PAIR

MATERIAL Synthetic
FEATURE Ergonomically shaped handle
COLOURS GR: Green
Y: Yellow
R: Red

4 "SALT & PEPPER" SHAKERS, PAIR

MATERIAL Synthetic
FEATURE Different sounding fillings

5 EGG SHAKERS, PAIR

MATERIAL Synthetic
COLOURS AU: Aubergine
SB: Sky Blue
GG: Grass Green
OR: Orange
R: Red
SP: Strawberry Pink
Y: Yellow
SB: Black



Large
NINO564

Medium
NINO563

Small
NINO562

Small pair
NINO562-2



Small
NINO1

Large
NINO2



NINO565



NINO10



NINO501



Blue
NINO955B

Green
NINO955GR

Red
NINO955R



Blue
NINO576B

Green
NINO576GR



Regular
NINO574

Small
NINO502



Orange
NINO576OR

Red
NINO576R

6 WOOD EGG SHAKERS

SIZES **NINO562**: Small
NINO562-2: Pair, small
NINO563: Medium
NINO564: Large
MATERIAL Siam Oak (*Hevea brasiliensis* Muell.-Arg.)

7 WOOD SHAKERS

SHAPES **NINO1**: Cylindrical, small
NINO2: Cylindrical, large
MATERIAL Siam Oak (*Hevea brasiliensis* Muell.-Arg.)
FEATURE Different sounding fillings

8 WOOD EGG MARACAS, PAIR

SIZE Small
MATERIAL Siam Oak (*Hevea brasiliensis* Muell.-Arg.)
FEATURE Ergonomically shaped handle

9 RAWHIDE MARACAS, PAIR

SIZE Small
MATERIAL Natural rawhide
FEATURE Ergonomically shaped wood handle

10 CAXIXI

MATERIAL Rattan with natural hide bottom

11 MINI CAJON SHAKERS

MATERIAL Baltic Birch (*Betula pendula*)
COLOURS **B**: Blue
GR: Green
R: Red

12 RATTLE STICKS, PAIR

MATERIAL Siam Oak (*Hevea brasiliensis* Muell.-Arg.)
COLOURS **B**: Blue
GR: Green
OR: Orange
R: Red

13 WOOD CLAVES, PAIR

SIZES **NINO502**: Small
NINO574: Regular
MATERIAL Siam Oak (*Hevea brasiliensis* Muell.-Arg.)

HAND PERCUSSION



1 JINGLE STICKS

MATERIALS ABS molded frame
Nickel Silver plated steel jingles

FEATURE Ergonomically shaped handle

COLOURS **BK:** Black
R: Red
Y: Yellow

2 SLEIGH BELL

MATERIALS Wooden handle
4 steel bells

FEATURE Ergonomic grip

3 CABASAS

SIZES **NINO701:** Small
NINO702: Medium

MATERIALS Beech Wood
Steel chain and cylinder

FEATURE Ergonomically shaped wooden handle

4 BELL STICK

MATERIALS Wooden handle
Steel bell

FEATURE Ergonomically shaped handle

5 DOUBLE BELL STICK

MATERIALS Wooden handle
2 steel bells

FEATURE Ergonomically shaped handle

6 WRIST BELLS

MATERIALS Nylon strap
3 steel bells

FEATURE Hook and loop fastener

COLOURS **B:** Blue
GR: Green
R: Red

7 ALSO AVAILABLE AS SETS



Sky Blue **NINO4SB** Grass Green **NINO4GG** Yellow **NINO4Y** Red **NINO4R** Strawberry Pink **NINO4SP**



Sky Blue **NINO45SB** Grass Green **NINO45GG** Yellow **NINO45Y** Red **NINO45R** Strawberry Pink **NINO45SP**

3+



Sky Blue **NINO5SB** Grass Green **NINO5GG** Yellow **NINO5Y** Red **NINO5R**



Sky Blue **NINO6SB** Grass Green **NINO6GG** Yellow **NINO6Y** Red **NINO6R**

5+



NINO965

3+



8" **NINO43**

10" **NINO27**

3+

5+



Goatskin head, 10" **NINO36**

True Feel synthetic head, 10" **NINO38**

10

5+

7 ABS HAND DRUMS

- SIZES** **NINO4**: 6" diameter
NINO45: 8" diameter
NINO5: 10" diameter
NINO6: 12" diameter
- MATERIALS** ABS molded frame
 Synthetic head
- INCLUDES** Wooden beater
- COLOURS** **GG**: Grass Green
R: Red
SB: Sky Blue
SP: Strawberry Pink
Y: Yellow

8 HAND DRUMS, PAIR

- MATERIALS** ABS molded frame
 Synthetic head
 Baltic Birch (*Betula*)
- CONTAINS** ABS Hand Drum 6", 1 pc.
 ABS Hand Drum 8", 1 pc.
- INCLUDES** Wooden stand
 Wooden beaters, 2 pcs.

9 WOOD HAND DRUMS

- SIZES** **NINO43**: 8" diameter
NINO27: 10" diameter
- MATERIALS** Wooden frame
 Synthetic head

10 TUNABLE HAND DRUMS

- SIZE** 10" diameter
- MATERIALS** Wooden frame
NINO36: Hand selected goatskin head
NINO38: True Feel synthetic head
- FEATURES** Chrome plated hardware
 Countersunk bolt lugs
 Replaceable head
- INCLUDES** Tuning key

HAND PERCUSSION



1
3+
Sky Blue NINO49SB Grass Green NINO49GG Yellow NINO49Y Red NINO49R Strawberry Pink NINO49SP



2
5+
Sky Blue NINO51SB Grass Green NINO51GG Yellow NINO51Y Red NINO51R Strawberry Pink NINO51SP



3
3+ 5+
1 row, 8" NINO46 2 rows, 8" NINO50 1 row, 10" NINO14 2 rows, 10" NINO15



Sky Blue NINO24SB Grass Green NINO24GG Yellow NINO24Y Red NINO24R



4
3+ 5+
1 row, 8" NINO47 1 row, 10" NINO25



5
NEW 3+
1 row, 6" NINO941 1 row, 8" NINO943 2 rows, 8" NINO945



6
NEW 3+
1 row, 6" NINO942 1 row, 8" NINO944 2 rows, 8" NINO946

1 COMPACT ABS TAMBOURINES

SIZE 8" diameter
MATERIALS ABS molded frame
Stainless steel jingles
FEATURES 1 row version
Extra wide grip
Durable frame
Compact size
COLOURS **GG:** Grass Green
R: Red
SB: Sky Blue
SP: Strawberry Pink
Y: Yellow

2 ABS TAMBOURINES

SIZES **NINO51:** 8" diameter
NINO24: 10" diameter
MATERIALS ABS molded frame
Synthetic head
Nickel Silver plated steel jingles
INCLUDES Wooden beater
COLOURS **GG:** Grass Green
R: Red
SB: Sky Blue
SP: Strawberry Pink
Y: Yellow





3+

5+



8"
NINO044



10"
NINO034



12"
NINO035



14"
NINO030

8 5+ 3+



24"
NINO-SRS1-L

18"
NINO-SRS1-M

9 5+



12"
NINO-WRM1



HAND PERCUSSION

3 TRADITIONAL WOOD TAMBOURINES

SIZES NINO046, NINO050: 8" diameter
NINO14, NINO15: 10" diameter

MATERIALS Wooden frame
Nickel Silver plated steel jingles

FEATURES NINO14, NINO046: 1 row version
NINO15, NINO050: 2 row version

4 TRADITIONAL HEADED WOOD TAMBOURINES

SIZES NINO47: 8" diameter
NINO25: 10" diameter

MATERIALS Wooden frame
Synthetic head
Nickel Silver plated steel jingles

FEATURE 1 row version

INCLUDES Wooden beater

5 WOOD TAMBOURINES

SIZES NINO941: 6" diameter
NINO943, NINO945: 8" diameter

MATERIALS Wooden frame
Nickel Silver plated steel jingles

FEATURES NINO941, NINO943: 1 row version
NINO945: 2 row version

6 HEADED WOOD TAMBOURINES

SIZES NINO942: 6" diameter
NINO944, NINO946: 8" diameter

MATERIALS Wooden frame
Synthetic head
Nickel Silver plated steel jingles

FEATURES NINO942, NINO944: 1 row version
NINO946: 2 row version

7 SEA DRUMS

SIZES NINO044: 8" diameter
NINO034: 10" diameter
NINO035: 12" diameter
NINO030: 14" diameter

MATERIALS Siam Oak frame
(*Hevea brasiliensis* Muell.-Arg.)
Two clear synthetic heads

8 SYNTHETIC RAINSTICKS

SIZES NINO-SRS1-M: 18" long
NINO-SRS1-L: 24" long

MATERIAL Lightweight synthetic

FINISH Sunshine

9 WOOD RAINMAKER

SIZE 12" long

MATERIAL Baltic Birch (*Betula Pendula*)

FEATURE Rounded corners

HAND PERCUSSION

1 3+



NINO585

2 4+



NINO557

3 3+



NINO556

4 3+



NINO519

5 3+



2 rows
NINO560

3 rows
NINO561

6 3+

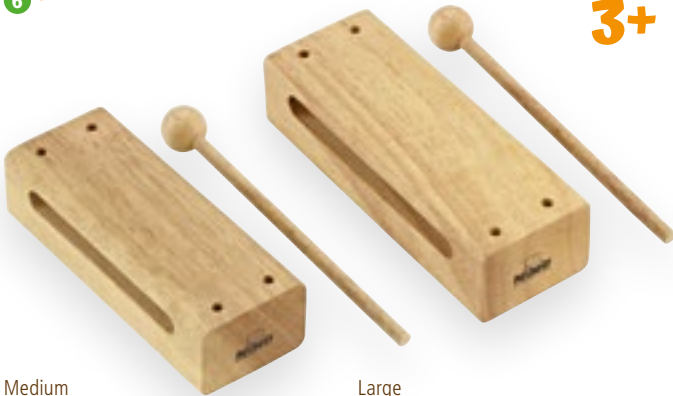

Medium
NINO21

Large
NINO22

7 3+



Large
NINO571

Medium
NINO570

1 WOOD HAND CASTANET

MATERIAL Siam Oak (*Hevea brasiliensis* Muell.-Arg.)
FEATURE Attractive shape

2 WOOD BALL STIRRING DRUM

MATERIAL Siam Oak (*Hevea brasiliensis* Muell.-Arg.)
FEATURE Ergonomically shaped handle

3 WOOD STIRRING DRUM

MATERIAL Siam Oak (*Hevea brasiliensis* Muell.-Arg.)
FEATURE Ergonomically shaped handle
INCLUDES Wooden beater

4 WOODPECKER

MATERIAL Siam Oak (*Hevea brasiliensis* Muell.-Arg.)

5 WOOD A-GO-GO'S

SIZES NINO560: 2 rows
NINO561: 3 rows

MATERIAL Siam Oak (*Hevea brasiliensis* Muell.-Arg.)
FEATURES Different playing options
Ergonomically shaped handle

INCLUDES Wooden beater

6 WOOD BLOCKS

SIZES NINO21: Medium
NINO22: Large

MATERIAL Siam Oak (*Hevea brasiliensis* Muell.-Arg.)
INCLUDES Wooden beater

7 WOOD TONE BLOCKS

SIZES NINO570: Medium
NINO571: Large

MATERIAL Siam Oak (*Hevea brasiliensis* Muell.-Arg.)
FEATURE Tonally matched resonating bodies
INCLUDES Wooden beater

8 5+



NIN0555

9 3+



NIN0520

10 3+



Black
NIN0581BK

Red
NIN0581R

11 3+



X-Large
NIN0516GR



Large
NIN0515GR



Medium
NIN0514GR



Small
NIN0513GR



X-Small
NIN0517



HAND PERCUSSION

8 WOOD GÜIRO

MATERIAL Siam Oak (*Hevea brasiliensis* Muell.-Arg.)
INCLUDES Wooden scraper

9 WOOD GÜIRO SHAKER

MATERIAL Siam Oak (*Hevea brasiliensis* Muell.-Arg.)
FEATURE Additional shaker sound
INCLUDES Wooden scraper

10 MINI GÜIROS

SIZE Mini
INCLUDES Wooden scraper
COLOUR **BK:** Black
R: Red

11 WOOD FROG GÜIROS

SIZES **NIN0517:** X-Small
NIN0513GR: Small
NIN0514GR: Medium
NIN0515GR: Large
NIN0516GR: X-Large

MATERIAL Wood
INCLUDES Wooden scraper
COLOUR **GR:** Green

DRUM CIRCLE INSTRUMENTS

1 ALSO AVAILABLE AS SETS FOR THE CLASSROOM

4+



Blue
NINO950B



Green
NINO950GR



Yellow
NINO950Y



Orange
NINO950OR



Red
NINO950R

4+

10+

2

10+

3

4+



Natural
NINO950



Natural
NINO952

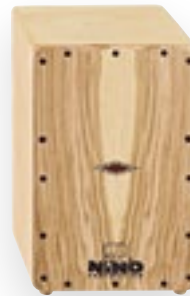

White Oak
AE-NINO951



Dark Green
NINO951DG

4

5+

5

5+



Natural
NINO951-MYO



Dark Green
NINO951DG-MYO

1 CAJONS

SIZE NINO950
9 3/4" W x 13" H x 9 1/2" D
NINO952
12" W x 17 3/4" H x 11 3/4" D

MATERIAL Baltic Birch (*Betula*)

FEATURES Internal snare wires
Adjustable top corners

COLOURS B: Blue
GR: Green
OR: Orange
R: Red
Y: Yellow

2 ARTISAN EDITION CAJON, NINO LINE

SIZE 9" W x 14 3/4" H x 9 1/2" D

MATERIALS Frontplate: White Oak
Resonating Body: Baltic Birch (*Betula*)

FEATURES 8 pre-tuned internal metal strings for a sensitive snare effect
Baltic Birch resonating body with rear port
Made in Spain

3 CHALKBOARD CAJON

SIZE 10 1/4" W x 15" H x 10 1/4" D

MATERIAL Baltic Birch (*Betula*)

FEATURES Internal snare wires
Adjustable top corners
Customizable frontplate

INCLUDES Chalk pack, 7 different colours

COLOUR DG: Dark Green

4 MAKE YOUR OWN CAJON

SIZE 10.25" W x 15" H x 10.25" D

MATERIAL Baltic Birch (*Betula*)

CONTAINS 1 x assembly instructions in nine languages
2 x side panels
1 x base, 1 x top & 1 x rear panel
1 x playing surface (with NINO® logo)
2 x side battens
1 x base & 1 x top batten
1 x securing batten for the snare
1 x snare
4 x rubber feet
15 x screws, 3 x 20 mm (for playing surface)
4 x screws, 4 x 15 mm (for rubber feet)
2 x screws, 3 x 12 mm (for snare)

FEATURES Internal snare wires
Includes stencil designs

COLOUR Natural



6

3+



NINO954

7

3+



NINO954-2

8

ALSO AVAILABLE AS SETS FOR THE CLASSROOM

3+

9

4+

Natural
NINO931Green
NINO931GRRed
NINO931RNatural
NINO953

5 MAKE YOUR OWN CHALKBOARD CAJON

SIZE	10.25" W x 15" H x 10.25" D
MATERIAL	Baltic Birch (<i>Betula</i>)
CONTAINS	1 x assembly instructions in nine languages 2 x side panels 1 x base, 1 x top & 1 x rear panel 2 x side battens 1 x base & 1 x top batten 1 x securing batten for the snare 1 x snare 4 x rubber feet 15 x screws, 3 x 20 mm (for playing surface) 4 x screws, 4 x 15 mm (for rubber feet) 2 x screws, 3 x 12 mm (for snare) 1 x customizable face with NINO® logo 1 x pack of chalk, 7 different colours
FEATURES	Internal snare wires Includes stencil designs
COLOUR	DG: Dark Green

6 CLASSROOM CAJON

SIZE	34" diameter
MATERIAL	Baltic Birch (<i>Betula</i>)
FEATURES	8 individual cajons connected in one unit Multi-coloured playing surfaces Internal snare wires
COLOURS	Natural, green, blue, red, orange, yellow

7 DELUXE CLASSROOM CAJON

SIZE	36" diameter
MATERIAL	Baltic Birch (<i>Betula</i>)
FEATURES	8 separate cajons Birch wood baseplate to hold the cajons together Internal snare wires
COLOURS	Natural, green, blue, red, orange, yellow

8 BONGO CAJONS

SIZE	12" W x 5 1/2" H x 5" D
MATERIAL	Baltic Birch (<i>Betula</i>)
FEATURE	High and low pitch playing surface
COLOURS	GR: Green R: Red

9 SLAPTOP CAJON

SIZE	15" W x 8" H x 7.5" D
MATERIAL	Baltic Birch (<i>Betula</i>)
FEATURES	Low and high notes for various beat combinations Internal snare wires Forward facing sound ports Sits comfortably in the lap
COLOUR	Natural

DRUM CIRCLE INSTRUMENTS

1 ALSO AVAILABLE AS SETS FOR THE CLASSROOM

3+



Grape NINO-EMDJ-GP Blueberry NINO-EMDJ-BB Sea Foam NINO-EMDJ-SF Green Apple NINO-EMDJ-GA Lemon NINO-EMDJ-LE Tangerine NINO-EMDJ-T Fire Engine NINO-EMDJ-FE Bubble Gum NINO-EMDJ-BG

Gold Metallic NINO-EMDJ-GM Silver Metallic NINO-EMDJ-SM Copper Metallic NINO-EMDJ-CM Flat Black NINO-EMDJ-FB Snow NINO-EMDJ-SN Twisted Amber NINO-EMDJ-TA Sunshine NINO-EMDJ-SU Pharaoh's Script NINO-EMDJ-PS Kenyan Quilt NINO-EMDJ-KQ

2 5+

3 5+

4+



Red/Black NINO18R/BK

Green/Yellow NINO18G/Y

Sunshine, 10" NINO-PDJ1-M-F

Sunshine, 10" NINO-PDJ1-M-G

Sunshine, 8" NINO-PDJ1-S-F

Sunshine, 8" NINO-PDJ1-S-G

1 ELEMENTS MINI DJEMBES

SIZE 6" diameter, 10 1/2" tall
MATERIALS Synthetic shell
 Synthetic head
FEATURES Outdoor Djembes
 100% synthetic head
 Ultra light weight
COLOURS **BB:** Blueberry
BG: Bubble Gum
CM: Copper Metallic
FB: Flat Black
FE: Fire Engine
GA: Green Apple
GM: Gold Metallic
GP: Grape
KQ: Kenyan Quilt
LE: Lemon
PS: Pharaoh's Script
SF: Sea Foam
SM: Silver Metallic

SN: Snow
SU: Sunshine
T: Tangerine
TA: Twisted Amber

2 ABS DJEMBES

SIZE 8" diameter, 13 3/4" tall
MATERIALS Molded ABS
 Synthetic heads
INCLUDES Nylon strap
COLOURS **G/Y:** Green/Yellow
R/BK: Red/Black

3 ROPE TUNED SYNTHETIC DJEMBES

SIZES **NINO-PDJ1-S:** 8" diameter, 16" tall
NINO-PDJ1-M: 10" diameter, 21" tall
MATERIALS Synthetic shell
NINO-PDJ1-S-F, NINO-PDJ1-M-F: Synthetic head
NINO-PDJ1-S-G, NINO-PDJ1-M-G: Hand selected goatskin head
PP ROPE 4 mm thickness, 30 runners
FEATURES Outdoor instrument
 100% synthetic shell
 Ultra light weight
 High quality PP nylon ropes
 Produces sharp slaps and deep bass tones
 Non-slip rubber bottom
FINISH Sunshine

4

4+

3+

4+

3+

EARTH RHYTHM SERIES



8"
NINO-ADJ3-S

7"
NINO-ADJ3-XS

4 1/2"
NINO-ADJ3-XXS

WATER RHYTHM SERIES



8"
NINO-ADJ2-S

7"
NINO-ADJ2-XS

4 1/2"
NINO-ADJ2-XXS

4+

3+

MOON RHYTHM SERIES



8"
NINO-ADJ4-S

7"
NINO-ADJ4-XS

4 1/2"
NINO-ADJ4-XXS

5

5+



10"
NINO48NT

DRUM CIRCLE INSTRUMENTS

4 ORIGINAL AFRICAN STYLE ROPE TUNED WOOD DJEMBES

- SIZES** **XXS:** 4 1/2" diameter, 8" tall
XS: 7" diameter, 11 3/4" tall
S: 8" diameter, 15 3/4" tall
- MATERIALS** Mahogany Wood
 Hand selected goatskin heads
- PP ROPES** **XXS:** 3 mm thickness, 10 runners
XS: 3 mm thickness, 20 runners
S: 4 mm thickness, 20 runners
- FEATURES** Carved from one solid piece of plantation grown Mahogany Wood
 High quality PP nylon ropes
 Hand carved shells
- COLOURS** **NINO-ADJ2:** Brown (Water Rhythm Series)
NINO-ADJ3: Brown/Black (Earth Rhythm Series)
NINO-ADJ4: Black (Moon Rhythm Series)

5 WOOD DJEMBE

- SIZE** 10" diameter, 21" tall
- MATERIALS** Siam Oak (*Hevea brasiliensis* Muell.-Arg.)
 Hand selected goatskin head
- FEATURES** Rounded rim for playing comfort
 Black powder coated hardware
- INCLUDES** Tuning key
- COLOUR** **N:** Natural



DRUM CIRCLE INSTRUMENTS

1

5+



Natural/Black
NINO3NT-BK



Natural/Harlekin
NINO3NT-HK



2

4+



Green/Yellow
NINO19G/Y



Red
NINO19R

3

5+



Blue
NINO17B-BK



Yellow
NINO17Y-BK



Red
NINO17R-BK

1 WOOD BONGOS

SIZES 6 1/2" Macho & 7 1/2" Hembra
MATERIALS Siam Oak (*Hevea brasiliensis* Muell.-Arg.)
 Hand selected buffalo heads
FEATURES Rounded rims for playing comfort
INCLUDES Tuning key
COLOURS **NT-BK:** Natural Shell / Black Hardware
NT-HK: Natural Shell / Harlekin Hardware

2 ABS BONGOS

SIZES 6 1/2" Macho & 7 1/2" Hembra
MATERIALS Molded ABS
 Synthetic heads
COLOURS **G/Y:** Green/Yellow
R: Red

3 ABS BONGOS PLUS

SIZES 6 1/2" Macho & 7 1/2" Hembra
MATERIALS Molded ABS
 Hand selected buffalo heads
FEATURES Rounded rims for playing comfort
 Black powder coated hardware
INCLUDES Tuning key
COLOURS **B-BK:** Blue Shell / Black Hardware
R-BK: Red Shell / Black Hardware
Y-BK: Yellow Shell / Black Hardware



Set, 2 pcs.
NINO89NT

4 WOOD CONGAS, PAIR

- SIZES** 8" & 9" head diameter, 22" tall
- MATERIALS** Siam Oak (*Hevea brasiliensis* Muell.-Arg.)
Hand selected buffalo heads
- FEATURES** Rounded rims for playing comfort
Black powder coated hardware
- INCLUDES** Basket stands
Tuning key
- COLOUR** NT: Natural



SOUND INSTRUMENTS

1 **3+**



Small
NINO579S



Medium
NINO579M



Large
NINO579L



3 rows
NINO580

2 **4+**



NINO600

4 **4+**



NINO505

5 **4+**



NINO602R

3 **4+**



4"
NINO550

6"
NINO551

8"
NINO552

6 **5+**



FX9, 12"
NINO-NS305



FX9, 14"
NINO-NS355

7 **5+**



FX9, 7"
NINO-NS18



FX9, 8"
NINO-NS20



Bronze, 8"
NINO-BO20



Brass, 8"
NINO-BR20

1 ENERGY CHIMES

SIZES NINO579S: Small
NINO579M: Medium
NINO579L: Large
NINO580: 3 rows
MATERIAL Silver anodized aluminum alloy
INCLUDES Wooden beater

2 CHIMES

SIZE 12 bars
MATERIAL Silver anodized aluminum alloy

3 TRIANGLES

SIZES NINO550: Small (4")
NINO551: Medium (6")
NINO552: Large (8")
MATERIALS Steel
Wooden holder with braided nylon strap
INCLUDES Metal beater with rubber padded grip

4 A-GO-GO BELL

MATERIAL Black powder coated steel
INCLUDES Wooden beater

5 WAH-WAH TUBE

MATERIAL Anodized aluminum
INCLUDES Wooden stick with rubber beater
COLOUR R: Red

6 CYMBALS

SIZES NINO-NS305: 12"
NINO-NS355: 14"
MATERIAL FX9 alloy
INCLUDES Leather strap (BR6)

NINO® CYMBALS "MADE IN GERMANY"

The NINO® cymbals and cymbal pairs made out of valuable materials provide the best sound at an unbeatable price. The best possible sound and consistency is a result of our state-of-the-art cymbal manufacturing facility located in Germany.





NINO901



NINO902



g#, c', f', f'', c'''
NINO963GR

c', c', a', a, f', e', e''
NINO964R



Red
NINO980R

White
NINO980WH



7 CYMBALS, PAIR

SIZES NINO-NS18: 7"
NINO-BO20, NINO-BR20,
NINO-NS20: 8"
MATERIALS NINO-BO20: B8 bronze alloy
NINO-BR20: MS63 brass alloy
NINO-NS18, NINO-NS20: FX9 alloy
INCLUDES Leather strap (BR4)

8 GLOCKENSPIEL

TONES c, d, e, f, g, a, b, c
MATERIALS Pine Wood body
Removable colour-coded metal keys
INCLUDES Two wooden mallets
Songbook
FINISH Matte

9 C MAJOR SCALE GLOCKENSPIEL

TONES c3, d3, e3, f-sharp3, g3, a3, b-flat3, b3,
c4, d4, e4, f4, f3
MATERIALS Wooden body
Removable steel keys
INCLUDES Two wooden mallets
FINISH Matte

10 WOOD KALIMBAS

TONES NINO963GR: g#, c', f', f'', c'''
NINO964R: c', c', a', a, f', e', e''
MATERIALS Radiata Pine (*Pinups Radiata*)
Chrome plated steel keys
FEATURES Solid wood construction
Light and pleasant sound
COLOURS GR: Green
R: Red

11 MINI MELODY STEEL TONGUE DRUMS

SIZE 6"
MATERIAL Steel
TUNING C5, D5, E5, G5, A5, C6
FEATURES Miniature size Steel Tongue Drum
Pre-tuned scale
Creates a soothing and tranquil tone
INCLUDES Bag
Rubber mallet pair
COLOURS R: Red
WH: White

ACCESSORIES

1
NEW



NEW



NINO-WB1

NINO-WB2

2
3+



NINO957

3
3+



NINO958

4
3+



Set, 8 pcs.
NINO959

1 WOODEN STORAGE BOXES

SIZES NINO-WB1: 14,5" W x 9,25" H x 6,1" D
NINO-WB2: 14,5" W x 14,5" H x 9" D
MATERIAL Baltic Birch (*Betula*)

2 WOODEN CLASSROOM CAJON STAND

SIZE 34.5" diameter
MATERIAL Baltic Birch (*Betula*)
FEATURES Two piece assembly
Designed for the Classroom Cajon (NINO954)
Protective corners to keep from scratching
COLOUR Natural

3 WOODEN DELUXE CLASSROOM CAJON STAND

SIZE 36.5" diameter
MATERIAL Baltic Birch (*Betula*)
FEATURES Two piece assembly
Designed for the Deluxe Classroom Cajon (NINO954-2)
Protective corners to keep from scratching
COLOUR Natural

4 WOODEN STOOLS, 8 PCS.

SIZE 12.5" height
MATERIAL Baltic Birch (*Betula*)
FEATURES 8 stools for Classroom Cajon and Deluxe Classroom Cajon
Perfect height to play the instruments when they are placed on a stand
COLOURS Natural, green, blue, red, orange, yellow

5 WOODEN BEATER

MATERIAL Siam Oak (*Hevea brasiliensis* Muell.-Arg.)
FEATURE Can be used for most percussion instruments

6 PERCUSSION MALLETS

SIZE 10" long
MATERIALS White Beech
NINO970: Natural felt
NINO971: Rubber
FEATURES Great to use with woodblocks, hand drums, and other commonly found percussion instruments
Extremely versatile and durable
Different options for sound and touch
Made in Germany
NINO970: Big felt head, medium hard
NINO971: Small rubber head, medium hard



NIN09



NIN0970

NIN0971



NIN0972

NIN0973

NIN0974



NIN0567



For 7", 8"
BR4

For 12", 14"
BR6



5+



For 8" congas
NISTAND-08



For 9" congas
NISTAND-09

5+

NIN020

7 DRUMSTICKS, PAIR

SIZE 14" length, 0.520" diameter
MATERIAL American Hickory
FEATURES Oval wood tip
 Weight and pitch matched
COLOURS NIN0972: Blue
 NIN0973: Red
 NIN0974: Green

8 TRIANGLE BEATER

MATERIAL Steel

9 LEATHER STRAPS

SIZES BR4: For 7" and 8" cymbals
 BR6: For 12" and 14" cymbals
MATERIAL Leather
FEATURES Easily hold the cymbals in the traditional marching grip
 BR4: Sold in pairs

10 BONGO STAND

MATERIAL Chrome plated steel
FEATURES Fully height adjustable from 31" to 45"
 90° angle adjustable
 Tripod stand with rubber feet
 Suitable for other common bongo models

11 CONGA BASKET STANDS

SIZES NISTAND-08: For 8" congas
 NISTAND-09: For 9" congas
MATERIAL Black powder coated steel
FEATURES Holds your conga in place
 Heavy construction
 Leaves sound unaffected



Meinl Sonic Energy is ... Your Sound Journey

Step into a journey with us. A journey to find more calmness, focus and relaxation. A journey to discover fresh, energizing sounds through instruments designed for anyone to **explore, create and feel**.

Explore

There is so much to explore about the world of Meinl Sonic Energy, from singing bowls with pure tones to enormous vibrating gongs and dream inspiring handpans to muscle relaxing tuning forks. You'll discover yourself in a whole new light with the aid of our instruments, and gain guidance on the road to harmony and better quality of life.

Create

This isn't about performance – anyone can create with Sonic Energy instruments. A musical background isn't required. The way we design these instruments immediately activates your senses and opens your mind when you play them. It will come natural to create beautiful and calming sounds that fill your surroundings with ethereal tone.

Feel

You will feel the vibrations of the Sonic Energy tools as they move through your body, melting away tension. Imagine the sound waves clearing and alleviating anything that could be weighing you down on your path. Get ready for a full body immersion of relaxation and restoration for the mind, body and spirit.

Focus your mind, clear out negative energy and **enjoy your sound journey**.



Crystal Singing Bowls	140-144	Steel Tongue Drums	168-169
Crystal Singing Chalices	145	Kalimbas	170-171
Singing Bowls	146-151	Chimes & Bell	172-173 / 177
Gongs	152-159	Energy Chimes	174-175
Tuning Forks	160-161	Sound Effects	175-177
Therapy Tuning Forks	162-163	Didgeridoos	177
Crystal Tuning Forks	163	Frame Drums	178-179
Handpans	164-167		

CRYSTAL SINGING BOWLS

1



Crown Chakra, 8" / 20 cm
CSB8B



Heart Chakra, 8" / 20 cm
CSB8F



Brow Chakra, 9" / 22 cm
CSB9A



Throat Chakra, 10" / 25 cm
CSB10G



Heart Chakra, 10" / 25 cm
CSB10F



Navel Chakra, 10" / 25 cm
CSB10E



Sacral Chakra, 10" / 25 cm
CSB10D



Heart Chakra, 11" / 28 cm
CSB11F



Heart Chakra, 12" / 30 cm
CSB12F



Navel Chakra, 12" / 30 cm
CSB12E



Sacral Chakra, 12" / 30 cm
CSB12D



Root Chakra, 12" / 30 cm
CSB12C



Sacral Chakra, 13" / 33 cm
CSB13D



Root Chakra, 14" / 35 cm
CSB14C



Throat Chakra, 14" / 35 cm
CSB14G

NEW

1 CRYSTAL SINGING BOWLS

SIZES
CSB8: 8" / 20 cm diameter
CSB9: 9" / 22 cm diameter
CSB10: 10" / 25 cm diameter
CSB11: 11" / 28 cm diameter
CSB12: 12" / 30 cm diameter
CSB13: 13" / 33 cm diameter
CSB14: 14" / 35 cm diameter

MATERIAL
 Gemstone (Quartz)

TUNING
 A4/a' 432 Hz

CSB8B: Crown Chakra, B4 ~484.9 Hz
CSB8F: Heart Chakra, F4 ~342.88 Hz
CSB9A: Brow Chakra, A4 ~432 Hz
CSB10D: Sacral Chakra, D4 ~288.33 Hz
CSB10E: Navel Chakra, E4 ~323.63 Hz
CSB10F: Heart Chakra, F4 ~342.88 Hz
CSB10G: Throat Chakra, G4 ~384.87 Hz
CSB11F: Heart Chakra, F4 ~342.88 Hz
CSB12C: Root Chakra, C4 ~256.87 Hz
CSB12D: Sacral Chakra, D4 ~288.33 Hz

FEATURES

CSB12E: Navel Chakra, E4 ~323.63 Hz
CSB12F: Heart Chakra, F4 ~342.88 Hz
CSB13D: Sacral Chakra, D4 ~288.33 Hz
CSB14C: Root Chakra, C4 ~256.87 Hz
CSB14G: Throat Chakra, G3 ~192.43 Hz

Made of high-purity quartz
 White-frosted
 Extremely long-lasting resonance
 Includes White silicone ring

INCLUDES

2 CRYSTAL SINGING BOWL CHAKRA SET

CONTAINS
 CSB8B (Crown Chakra), CSB9A (Brow Chakra), CSB10G (Throat Chakra), CSB11F (Heart Chakra), CSB12E (Navel Chakra), CSB13D (Sacral Chakra), CSB14C (Root Chakra)

INCLUDES
 7 x white silicone ring
 Crystal silicone rods (CSBRM, CSBRHL)
 Crystal singing bowl mallet (CSBM)

3 CRYSTAL SINGING BOWL COLOUR-FROSTED CHAKRA SET

CONTAINS
 CSBC8B (Crown Chakra), CSBC9A (Brow Chakra), CSBC10G (Throat Chakra), CSBC11F (Heart Chakra), CSBC12E (Navel Chakra), CSBC13D (Sacral Chakra), CSBC14C (Root Chakra)

INCLUDES
 7 x white silicone ring
 Crystal silicone rods (CSBRM, CSBRHL)
 Crystal singing bowl mallet (CSBM)

4 CRYSTAL SINGING BOWLS COLOUR-FROSTED

SIZES
CSBC8: 8" / 20 cm diameter
CSBC9: 9" / 22 cm diameter
CSBC10: 10" / 25 cm diameter
CSBC11: 11" / 28 cm diameter
CSBC12: 12" / 30 cm diameter
CSBC13: 13" / 33 cm diameter
CSBC14: 14" / 35 cm diameter

2



Set, 7 pcs.
CSBSETCHA

3



Set, 7 pcs.
CSBSETCHA

4



Crown Chakra, 8" / 20 cm
CSBC8B



Brow Chakra, 9" / 22 cm
CSBC9A



Throat Chakra, 10" / 25 cm
CSBC10G



Heart Chakra, 11" / 28 cm
CSBC11F



Navel Chakra, 12" / 30 cm
CSBC12E



Sacral Chakra, 13" / 33 cm
CSBC13D



Root Chakra, 14" / 35 cm
CSBC14C

- MATERIAL** Gemstone (Quartz)
TUNING A4/a' 440 Hz
CSBC8B: Crown Chakra, B4 ~493.88 Hz
CSBC9A: Brow Chakra, A4 ~440 Hz
CSBC10G: Throat Chakra, G4 ~392 Hz
CSBC11F: Heart Chakra, F4 ~349.23 Hz
CSBC12E: Navel Chakra, E4 ~329.63 Hz
CSBC13D: Sacral Chakra, D4 ~293.67 Hz
CSBC14C: Root Chakra, C4 ~261.63 Hz
- FEATURES**
Made of high-purity quartz
Gradient colour (exterior frosted colour)
Extremely long-lasting resonance
- INCLUDES** White silicone ring
- COLOURS**
CSBC8B: Purple
CSBC9A: Dark Blue
CSBC10G: Light Blue
CSBC11F: Green
CSBC12E: Yellow
CSBC13D: Orange
CSBC14C: Red



CRYSTAL SINGING BOWLS

1 NEW



Mi 528 Hz, 8" / 20 cm
SOLCSB8-528



Ut 396 Hz, 10" / 25 cm
SOLCSB10-396



Re 417 Hz, 10" / 25 cm
SOLCSB10-417



Fa 639 Hz, 10" / 25 cm
SOLCSB10-639



Sol 741 Hz, 10" / 25 cm
SOLCSB10-741



La 852 Hz, 10" / 25 cm
SOLCSB10-852



963 Hz, 10" / 25 cm
SOLCSB10-963



174 Hz, 12" / 30 cm
SOLCSB12-174



285 Hz, 12" / 30 cm
SOLCSB12-285

2 NEW



Set, 6 pcs.
SOLCSBSET

1 SOLFEGGIO CRYSTAL SINGING BOWLS

- SIZES** **SOLCSB8:** 8" / 20 cm diameter
SOLCSB10: 10" / 25 cm diameter
SOLCSB12: 12" / 30 cm diameter
- MATERIAL** Gemstone (Quartz)
- TUNING**
174: 174 Hz / F3
285: 285 Hz / C#4
396: Ut 396 Hz / G4
417: Re 417 Hz / G#4
528: Mi 528 Hz / C5
639: Fa 639 Hz, 319.5 Hz / D#4
741: Sol 741 Hz, 370.5 Hz / F#4
852: La 852 Hz, 426 Hz / G#4
963: 963 Hz, 481.5 Hz / B4
- FEATURES** Made of high-purity quartz
White-frosted
Extremely long-lasting resonance
Printed logo
- INCLUDES** White silicone ring

2 SOLFEGGIO CRYSTAL SINGING BOWL SET

- CONTAINS** SOLCSB10-396 (Ut 396 Hz),
SOLCSB10-417 (Re 417 Hz),
SOLCSB8-528 (Mi 528 Hz),
SOLCSB10-639 (Fa 639 Hz),
SOLCSB10-741 (Sol 741 Hz),
SOLCSB10-852 (La 852 Hz)
- INCLUDES** 6 x white silicone ring
Crystal Silicone Rod (CSBRM)
Crystal Singing Bowl Mallet (CSBM)

3 NEW



Schumann Resonance, 12" / 30 cm
PCSB12SF



Venus, 12" / 30 cm
PCSB12V



Synodic Moon, 12" / 30 cm
PCSB12MSY



Synodic Day, 12" / 30 cm
PCSB12ESY



Jupiter, 12" / 30 cm
PCSB12J



Chiron, 12" / 30 cm
PCSB12CH



Earth Platonic Year, 12" / 30 cm
PCSB12EPL



Mars, 12" / 30 cm
PCSB12MA



Mercury, 12" / 30 cm
PCSB12ME



Earth Year/Om, 12" / 30 cm
PCSB12E



Sun, 12" / 30 cm
PCSB12S



4 NEW



Set, 7 pcs.
PCSBSETCHA

SINGING BOWLS

3 PLANETARY TUNED CRYSTAL SINGING BOWLS

- SIZE** 12" / 30 cm diameter
MATERIAL Gemstone (Quartz)
TUNING **CH:** Chiron 172.86 Hz / F3 (A4/a' 440 Hz » 435.58 Hz)
E: Earth Year/Om 136.10 Hz, 272.2 Hz / C#4 (A4/a' 440 Hz » 432.09 Hz)
EPL: Earth Platonic Year 172.06 Hz / F3 (A4/a' 440 Hz » 433.56 Hz)
ESY: Synodic Day 194.18 Hz / G3 (A4/a' 440 Hz » 435.92 Hz)
J: Jupiter 183.58 Hz / F#3 (A4/a' 440 Hz » 436.63 Hz)
MA: Mars 144.72 Hz, 289.44 Hz / D4 (A4/a' 440 Hz » 433.67 Hz)
ME: Mercury 141.27 Hz, 282.54 Hz / C#4 (A4/a' 440 Hz » 448.50 Hz)

FEATURES

- MSY:** Synodic Moon 210.42 Hz / G#3 (A4/a' 440 Hz » 445.86 Hz)
S: Sun 126.22 Hz, 252.44 Hz / B3 (A4/a' 440 Hz » 449.80 Hz)
SF: Schumann Resonance 250.56 Hz / B3 (A4/a' 440 Hz » 446.56 Hz)
V: Venus 221.23 Hz / A3 (A4/a' 440 Hz » 442.46 Hz)
FEATURES Made of high-purity quartz
White-frosted
Extremely long-lasting resonance
Printed logo
INCLUDES White silicone ring

4 PLANETARY TUNED CRYSTAL SINGING BOWL CHAKRA SET

- CONTAINS** PCSB12EPL (Crown Chakra), PCSB12V (Brow Chakra), PCSB12ME (Throat Chakra), PCSB12E (Heart Chakra), PCSB12S (Navel Chakra), PCSB12MSY (Sacral Chakra), PCSB12ESY (Root Chakra)
INCLUDES 7 x white silicone ring
Crystal Silicone Rod (CSBRL)
Crystal Singing Bowl Mallet (CSBM)

CRYSTAL SINGING BOWLS & ACCESSORIES

1 NEW



Flower of Life, 8" / 20 cm
PCSB8FOL



NEW

Flower of Life, 10" / 25 cm
PCSB10FOL



OM, 8" / 20 cm
CSB8OM



2



Crown Chakra, 8" / 20 cm
CSBH8B



Heart Chakra, 10" / 25 cm
CSBH10F

3



Medium
CSBRM

Large
CSBRL

Medium
CSBRHM

Large
CSBRHL

4



Crown Chakra, Amethyst, 8" / 20 cm
CSBA8B

5



Heart Chakra, Rose Quartz, 10" / 25 cm
CSBR10F

6



Heart Chakra, Emerald, 10" / 25 cm
CSBE10F

7



Mallet
CSBM

8



8" / 20 cm
CSBB8

10" / 25 cm
CSBB10

12" / 30 cm
CSBB12

14" / 35 cm
CSBB14

9



Set, 6 pcs.
CSBPSSET

1 FLOWER OF LIFE CRYSTAL SINGING BOWLS & OM CRYSTAL SINGING BOWL

SIZE 8" / 20 cm diameter

MATERIAL Gemstone (Quartz)

TUNING **PCSB8FOL**: 128 Hz, 512 Hz / C5

(A4/a' 440 Hz » 430.54 Hz)

PCSB10FOL: 128 Hz, 256 Hz / C4

(A4/a' 440 Hz » 430.54 Hz)

CSB8OM: C#5 ~544.29 Hz

(A4/a' 432 Hz)

FEATURES Made of high-purity quartz; White-frosted; Extremely long-lasting resonance

PCSB8FOL, PCSB10FOL: Printed logo

CSB8OM: Engraved logo

INCLUDES White silicone ring

SYMBOLS **FOL**: Flower of Life

OM: OM

2 CRYSTAL SINGING BOWLS WITH HANDLE

SIZES **CSBH8B**: 8" / 20 cm diameter

CSBH10F: 10" / 25 cm diameter

MATERIAL Gemstone (Quartz)

TUNING **CSBH8B**: Crown Chakra, B4 ~484.9 Hz

CSBH10F: Heart Chakra, F4 ~342.88 Hz

FEATURES White-frosted bowl with clear hollow

handle to hold; Precisely control the

healing vibrations; Extremely long-

lasting resonance

3 CRYSTAL SILICONE RODS

SIZES **M**: Medium (7.8")

L: Large (9.0")

MATERIAL Silicone coated glass

FEATURES Perfect for gently tapping or rubbing

crystal singing bowls

CSBRHM, CSBRHL:

Glass handle for a comfortable grip

4 AMETHYST CRYSTAL SINGING BOWL

SIZE 8" / 20 cm diameter

MATERIALS Gemstones (Quartz and Amethyst)

TUNING A4/a' 432 Hz, Crown Chakra,

B4 ~484.9 Hz

FEATURE Extremely long-lasting resonance

INCLUDES White silicone ring

5 ROSE QUARTZ CRYSTAL SINGING BOWL

SIZE 10" / 25 cm diameter

MATERIALS Gemstones (Quartz and Rose Quartz)

TUNING A4/a' 432 Hz, Heart Chakra,

F4 ~342.88 Hz

FEATURE Extremely long-lasting resonance

INCLUDES White silicone ring

6 EMERALD CRYSTAL SINGING BOWL

SIZE 10" / 25 cm diameter

MATERIALS Gemstones (Quartz and Emerald)

CRYSTAL SINGING CHALICES & BAGS

10



Heart Chakra,
Flower of Life, 6" / 15 cm
CSC6FPFOL



Heart Chakra,
Flower of Life, 8" / 20 cm
CSC8FPFOL



Brow Chakra, 5.5" / 14 cm
CSC55AC



Root Chakra, 6.75" / 17 cm
CSC675CC



Crown Chakra, 7" / 18 cm
CSC7BCL



RESONANT Mallet PERFECT
FOR PLAYING CRYSTAL SINGING
CHALICES (SEE PAGE 150)



SB-RM-LE

11

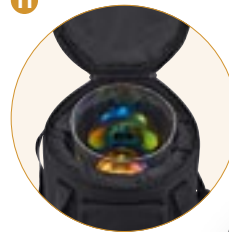

6" / 15 cm
CSCB6



7" / 18 cm
CSCB7



8" / 20 cm
CSCB8

NEW

SINGING BOWLS

TUNING A4/a' 432 Hz, Heart Chakra,
F4 ~342.88 Hz
FEATURE Extremely long-lasting resonance
INCLUDES White silicone ring

7 CRYSTAL SINGING BOWL Mallet

SIZE 7.8"
MATERIALS Wood; Rubber
FEATURE Comfortable wooden handle with a
rubber head

8 CRYSTAL SINGING BOWL BAGS

SIZES **CSCB8**: For 8" crystal singing bowls
CSCB10: For 9" to 10" crystal sing. bowls
CSCB12: For 11" to 12" crystal sing. bowls
CSCB14: For 13" to 14" crystal sing. bowls
MATERIAL Heavy-duty padded synthetic fabric
FEATURES Safe transport method; Carrying grip;
Double-slide zipper; External pocket
COLOUR Black

9 CRYSTAL SINGING BOWL PROTECTIVE SLEEVE SET

CONTAINS Six protective sleeves:
8", 9", 10", 11", 12", 13"
MATERIAL Neoprene
FEATURE Stack the whole Crystal Singing Bowl
Chakra Set in just two bags (2 x CSCB14)
COLOUR Black

10 CRYSTAL SINGING CHALICES

SIZES **CSC55AC**: 5.5" / 14 cm diameter
CSC6FPFOL: 6" / 15 cm diameter
CSC675CC: 6.75" / 17 cm diameter
CSC7BCL: 7" / 18 cm diameter
CSC8FPFOL: 8" / 20 cm diameter
MATERIAL Gemstone (Quartz)
TUNING A4/a' 440 Hz
CSC55AC: Brow Chakra, A4 ~440 Hz
CSC6FPFOL: Heart Chakra, F4 ~349.23 Hz
CSC675CC: Root Chakra, C4 ~261.63 Hz

FEATURES **CSC7BCL**: Crown Chakra, B3 ~246.94 Hz
CSC8FPFOL: Heart Chakra, F3 ~174.61 Hz
Made of high-purity quartz; Extremely
long-lasting resonance; Clear, strong,
deep, and rich vibrations
FINISHES **CSC55AC**, **CSC675CC**: Creamy
CSC6FPFOL: Pink
CSC7BCL: Clear
CSC8FPFOL: Purple
SYMBOL **FOL**: Flower of Life

11 CRYSTAL SINGING CHALICE BAGS

SIZES **CSCB6**: For 5.5" to 6" singing chalices
CSCB7: For 6.75" to 7" singing chalices
CSCB8: For 7.5" to 8" singing chalices
MATERIAL Heavy-duty padded synthetic fabric
FEATURES Safe transport method; Reinforced
carrying grip; Double-slide zipper;
External pocket
COLOUR Black

SINGING BOWLS

1



~600 g
SB-O-600



~700 g
SB-O-700



~900 g
SB-O-900

2



Set, 3 pcs.
SB-O-2200

3



~400 g
SB-U-400



~500 g
SB-U-500



~600 g
SB-U-600



~700 g
SB-U-700



~750 g
SB-U-750

SHAPE



4



Set, 2 pcs.
SB-U-900



Set, 3 pcs.
SB-U-1500



Set, 4 pcs.
SB-U-1750



Set, 3 pcs.
SB-U-1950



Set, 5 pcs.
SB-U-2950

1 ORIGIN SERIES SINGING BOWLS

DIMENSIONS SB-O-600: ~5.1" diameter; ~600 g
SB-O-700: ~5.7" diameter; ~700 g
SB-O-900: ~6.7" diameter; ~900 g

MATERIAL Special bronze alloy

FEATURES Ideal for yoga and meditation

Handcrafted masterpiece made in India
Engraved logo on the bottom

INCLUDES Corresponding cover and felt ring

2 ORIGIN SERIES SINGING BOWL SET

CONTAINS SB-O-600, SB-O-700, SB-O-900

INCLUDES Corresponding covers and felt rings
Mallet (SB-M-ST-L)

3 UNIVERSAL SERIES SINGING BOWLS

DIMENSIONS SB-U-400: ~4.5" diameter; ~400 g
SB-U-500: ~4.9" diameter; ~500 g
SB-U-600: ~5.5" diameter; ~600 g
SB-U-700: ~5.9" diameter; ~700 g
SB-U-750: ~6.5" diameter; ~750 g

MATERIAL Special bronze alloy

FEATURES Ideal for yoga and meditation

Handcrafted masterpiece made in India
Engraved logo

INCLUDES Corresponding cover and felt ring

4 UNIVERSAL SERIES SINGING BOWL SETS

CONTAINS SB-U-900: SB-U-400, SB-U-500

SB-U-1500: SB-U-400, SB-U-500,
SB-U-600

SB-U-1750: SB-U-400, SB-U-500,
SB-U-600, SB-C-250

SB-U-1950: SB-U-500, SB-U-700,
SB-U-750

SB-U-2950: SB-U-400, SB-U-500,
SB-U-600, SB-U-700, SB-U-750

INCLUDES Corresponding covers and felt rings
Resonant Mallet (SB-RM-LE)

SB-U-2950: Mallet (SB-M-LT-S)

5

SHAPE



~700 g
SB-E-700



~1000 g
SB-E-1000



~1400 g
SB-E-1400



~1800 g
SB-E-1800



~2200 g
SB-E-2200



~2500 g
SB-E-2500



6



Set, 3 pcs.
SB-E-3100

Therapy
Basis Set



Set, 3 pcs.
SB-E-4600



Set, 3 pcs.
SB-E-5400

SINGING BOWLS

**5 ENERGY THERAPY SERIES
SINGING BOWLS**

DIMENSIONS SB-E-700: ~6.4" diameter; ~700 g
SB-E-1000: ~7.8" diameter; ~1000 g
SB-E-1400: ~9.0" diameter; ~1400 g
SB-E-1800: ~10.2" diameter; ~1800 g
SB-E-2200: ~11.4" diameter; ~2200 g
SB-E-2500: ~12.2" diameter; ~2500 g

MATERIAL Special bronze alloy
FEATURES Ideal for upper body sound massage
Reinforcement rim that will produce a high tone at first followed afterwards by a deep tone
Handcrafted masterpiece made in India
Engraved logo

INCLUDES Corresponding cover and felt ring

**6 ENERGY THERAPY SERIES
SINGING BOWL SETS**

CONTAINS SB-E-3100: SB-E-700, SB-E-1000, SB-E-1400

SB-E-4600: SB-E-1000, SB-E-1400, SB-E-2200

SB-E-5400: SB-E-1400, SB-E-1800, SB-E-2200

INCLUDES Corresponding covers and felt rings
SB-E-3100: Resonant Mallet (SB-RM-LE), Mallet (SB-M-ST-L)

SB-E-4600: Professional Mallets (SB-PM-MF-S, SB-PM-MF-L)

SB-E-5400: Resonant Mallet (SB-RM-LE), Mallets (SB-M-LT-L, SB-M-ST-L)



SINGING BOWLS



1 COSMOS THERAPY SERIES SINGING BOWLS

DIMENSIONS **SB-C-250:** ~3.7" diameter; ~250 g
SB-C-650: ~5.8" diameter; ~650 g
SB-C-800: ~6.6" diameter; ~800 g
SB-C-1000: ~7.6" diameter; ~1000 g
SB-C-1500: ~9.0" diameter; ~1500 g
SB-C-2000: ~10.3" diameter; ~2000 g
SB-C-2500: ~11.5" diameter; ~2500 g

MATERIAL Special bronze alloy
FEATURES Ideal for yoga and meditation; Generates a sustained deep tone that will fill a room with ambient sounds; Handcrafted masterpiece made in India; Engraved logo
INCLUDES Corresponding cover and felt ring

2 SUCTION HOLDERS

SIZES **SBSHS:** Small (6.3")
SBSHM: Medium (7.9")
MATERIALS Beech handle; PVC suction pad

FEATURES Direct healing vibrations to specific areas of the body; Perfect for therapeutic use
SBSHS: For singing bowls up to 650 g
SBSHM: For singing bowls from 700 g to 1500 g

3 COSMOS THERAPY SERIES SUCTION HOLDER SINGING BOWL SET

CONTAINS SB-C-1500, SB-C-650
FEATURE Perfect for therapeutic use
INCLUDES Corresponding covers and felt rings
 Suction Holders (SBSHS, SBSHM)
 Resonant Mallet (SB-RM-LE)

4 COSMOS THERAPY SERIES SINGING BOWL SETS

CONTAINS **SB-C-2700:** SB-C-250, SB-C-650, SB-C-800, SB-C-1000
SB-C-3800: SB-C-800, SB-C-1000, SB-C-2000

SB-C-4750: SB-C-250, SB-C-1000, SB-C-1500, SB-C-2000
INCLUDES Corresponding covers and felt rings
SB-C-2700: Resonant Mallet (SB-RM-LE), Mallet (SB-M-LT-S)
SB-C-3800: Professional Mallets (SB-PM-MF-S, SB-PM-MF-L)
SB-C-4750: Resonant Mallet (SB-RM-LE), Mallets (SB-M-LT-L, SB-M-ST-L)

5 SINGING BOWL CHAKRA SET

CONTAINS SB-C-250 (Crown Chakra), SB-E-700 (Brow Chakra), SB-E-1000 (Throat Chakra), SB-E-1400 (Heart Chakra), SB-C-1500 (Navel Chakra), SB-E-1800 (Sacral Chakra), SB-E-2200 (Root Chakra)
INCLUDES Corresponding covers and felt rings
 Mallets (SB-M-LT-L, SB-M-ST-L, SB-M-ST-S, SB-M-LT-S)
 Professional Mallet (SB-PDM-F-XL)



6 SPECIAL ENGRAVED SERIES SINGING BOWLS

DIMENSIONS **SB-SE-600:** ~5.4" diameter; ~600 g
SB-SE-800: ~6.7" diameter; ~800 g
SB-SE-1000: ~8.0" diameter; ~1000 g

MATERIAL Special bronze alloy

FEATURES Perfect combination of a pleasing sound and look; Handcrafted masterpiece made in India; Brilliant finish; Hand-engraved ornamental design; Engraved logo

INCLUDES Corresponding cover and felt ring

7 SPECIAL ENGRAVED SERIES SINGING BOWL SET

CONTAINS SB-SE-600, SB-SE-800, SB-SE-1000

INCLUDES Corresponding covers and felt rings
 Resonant Mallet (SB-RM-LE)
 Mallet (SB-M-LT-S)

8 SYNTHESIS SERIES SINGING BOWLS

DIMENSIONS ~7.6" diameter; ~1000 g

MATERIAL Special bronze alloy

FEATURES Ideal for meditation, sound therapy, concerts and yoga; Generates a sustained deep tone that will fill a room with ambient sounds; Handcrafted masterpiece made in India; Engraved logo

INCLUDES Corresponding cover and felt ring

SYMBOLS **FOL:** Flower of Life
VF: Venus Flower

9 GROUNDING SERIES

DIMENSIONS **SB-G-5000:** ~15.8" diameter; ~5000 g
SB-G-9000: ~18.9" diameter; ~9000 g
SB-G-10000: ~19.7" diameter; ~10000 g
SB-G-11000: ~20.5" diameter; ~11000 g
SB-G-12000: ~20.9" diameter; ~12000 g
SB-G-13000: ~22.1" diameter; ~13000 g
SB-G-14000: ~23.2" diameter; ~14000 g

MATERIAL Special bronze alloy

FEATURES Ideal for sound therapy and can also be used for a full body experience by standing in these bowls; Handcrafted masterpiece made in India; Engraved logo

INCLUDES Corresponding buckwheat cushion

SINGING BOWL ACCESSORIES &

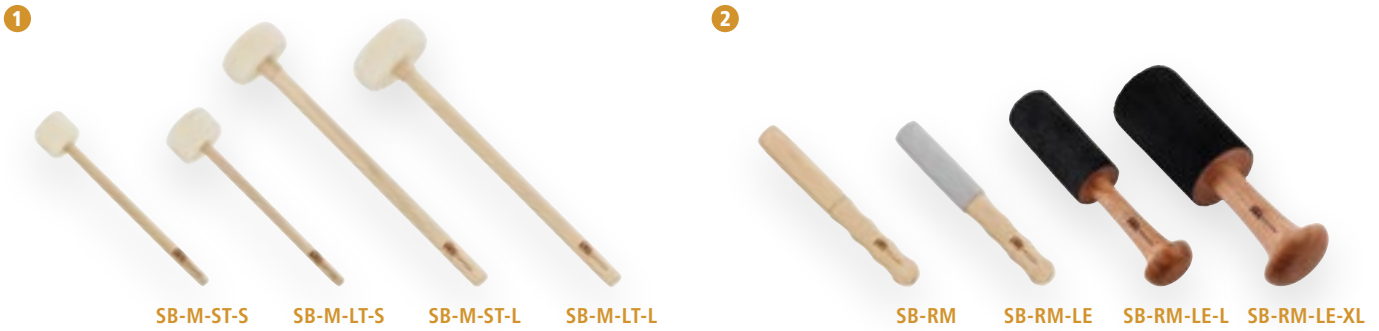

GONG BEATERS PERFECT FOR PLAYING SINGING BOWLS (SEE PAGE 158)

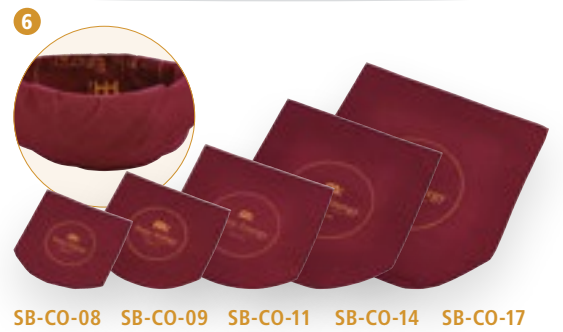

1 MALLETS

DIMENSIONS SB-M-ST-S: Small felt tip; Small (8.27")
SB-M-LT-S: Large felt tip; Small (8.27")
SB-M-ST-L: Small felt tip; Large (12.44")
SB-M-LT-L: Large felt tip; Large (12.44")
MATERIAL Indian eucalyptus tree wood

2 RESONANT MALLETS

DIMENSIONS SB-RM: Plain; 7.91"
SB-RM-LE: Suede leather; 7.91"
SB-RM-LE-L: Suede leather; 10.24"
SB-RM-LE-XL: Suede leather; 10.63"
MATERIAL Indian eucalyptus tree wood

3 PROFESSIONAL MALLETS

DIMENSIONS SB-PM-SR-S: Soft rubber tip; Small (8.86")
SB-PM-HFS-S: Hard felt, small tip; Small (8.86")

SB-PM-HFM-S: Hard felt, medium tip; Small (8.86")

SB-PM-HFL-L: Hard felt tip, Large (13.78")

SB-PM-MF-S: Medium felt tip; Small (12.01")

SB-PM-MF-M: Medium felt tip; Medium (12.99")

SB-PM-MF-L: Medium felt tip; Large (13.78")

SB-PDM-F/R-S: Double Mallet; Felt & rubber tip; Small (9.25")

SB-PDM-F-XL: Double Mallet; Felt tips; X-Large (15.94")

MATERIALS Sapele wood handle except: SB-PDM-F-XL: Maple handle

4 GROUNDING SINGING BOWL Mallet

DIMENSIONS Fleece tip, XX-Large (27.56")
MATERIALS Beech wood handle; Synthetic fleece

5 FELT RINGS

SIZES SB-FR-08: 3.15" diameter
SB-FR-10: 3.94" diameter
SB-FR-13: 5.12" diameter
SB-FR-16: 6.3" diameter

MATERIAL Natural felt
FEATURE Nonslip

6 COVERS

SIZES SB-CO-08: 8" x 8"
SB-CO-09: 9.5" x 9.5"
SB-CO-11: 11.5" x 11.5"
SB-CO-14: 14" x 15.5"
SB-CO-17: 17" x 19"

MATERIAL Synthetic
FEATURE Prevents from dust and fingerprints

ZEN, ORNAMENTAL, OM SINGING BOWLS

9



78" / 200 cm, Navy Blue
MMR1NB

78" / 200 cm, Vintage Gold
MMR1VG



10



12.2" / 31 cm, Beige
MMC

11



Set, 3 pcs.: ~170 g; ~260 g; ~340 g
SBZ2

12



Set, 3 pcs.: ~170 g; ~260 g; ~340 g
SBZ1



~300 g
SB-OR-300-BK



~300 g
SB-OR-300-R

13



~300 g
SB-OM-300



~400 g
SB-OR-400-BK



~400 g
SB-OR-400-R

7 BUCKWHEAT CUSHIONS

- SIZES** **SB-BC-10:** 3.94" diameter
SB-BC-16: 6.3" diameter
SB-BC-21: 8.27" diameter
SB-BC-26: 10.24" diameter
- FEATURES** Filled with buckwheat;
Transferring vibrations while playing

8 COTTON BAGS

- SIZES** **SB-CB-20:** 7.87" x 7.87"
SB-CB-25: 9.84" x 9.84"
SB-CB-30: 11.81" x 11.81"
SB-CB-38: 14.96" x 14.96"
SB-CB-50: 19.69" x 19.69"
- MATERIALS** Natural cotton linen fabric
Synthetic fleece inlay
- FEATURES** Safe transport method;
Prevents from scratches

9 MEDITATION RUGS

- SIZE** 78" / 200 cm diameter
- MATERIALS** 45% cotton, 45% polyester, 10% viscose
- FEATURES** Suitable as the center of your meditation instruments; Calming spot for relaxation; Washable at 30°C

10 MEDITATION CUSHION

- SIZE** 12.2" / 31 cm diameter,
7.87" / 20 cm height
- MATERIALS** Cotton; Buckwheat filling
- FEATURE** Washable at 30°C

11 ZEN SINGING BOWL SETS

- SIZES** 2.8"; 3.5"; 3.9" diameter
~170 g; ~260 g; ~340 g
- MATERIAL** Special cast alloy
- FEATURES** High and clear tone; Perfect for meditation
- INCLUDES** Cloth bags; Mallet
SBZ1: Felt coasters

12 ORNAMENTAL SERIES SINGING BOWLS

- DIMENSIONS** **SB-OR-300:** ~3.74" diameter; ~300 g
SB-OR-400: ~4.13" diameter; ~400 g
- MATERIAL** Special cast alloy
- FEATURES** Hand-painted ornamental design;
Great gift idea
SB-OR-300: Consistently warm,
high-pitched sound
SB-OR-400: Consistently warm,
low-pitched sound
- INCLUDES** Corresponding mallet and coaster
BK: Black gift box
R: Red gift box

13 OM SERIES SINGING BOWL

- DIMENSIONS** ~4.33" diameter; ~300 g
- MATERIAL** Special cast alloy
- FEATURES** Consistently warm, low-pitched sound;
Hand-painted OM design; Great gift idea
- INCLUDES** Corresponding mallet, ring and gift box

GONGS

1 BASED ON THE CALCULATIONS OF HANS COUSTO (THE COSMIC OCTAVE)



24" / 60 cm
G24CC7

24" / 60 cm
G24BC6

32" / 80 cm
G32TC5

36" / 90 cm
G36HC4

36" / 90 cm
G36NC3

24" / 60 cm
G24SC2

24" / 60 cm
G24RC1

2



50" / 125 cm
TT50

60" / 150 cm
TT60

3



TMGS-5

TMGS-4

1 CHAKRA GONGS

SIZES **G24:** 24" / 60 cm
G32: 32" / 80 cm
G36: 36" / 90 cm

MATERIAL Nickelsilver

TUNING **G24CC7:** Crown Chakra, 172.06 Hz / F2 (A4/a' 440 Hz » 433.56 Hz)
G24BC6: Brow Chakra, 221.23 Hz / A2 (A4/a' 440 Hz » 442.46 Hz)
G32TC5: Throat Chakra, 141.27 Hz / C#2 (A4/a' 440 Hz » 448.50 Hz)
G36HC4: Heart Chakra, 136.10 Hz / C#2 (A4/a' 440 Hz » 432.09 Hz)
G36NC3: Navel Chakra, 126.22 Hz / B1 (H1) (A4/a' 440 Hz » 449.80 Hz)
G24SC2: Sacral Chakra, 210.42 Hz / G#2 (A4/a' 440 Hz » 445.86 Hz)
G24RC1: Root Chakra, 194.18 Hz / G2 (A4/a' 440 Hz » 435.92 Hz)

FEATURES Handcrafted masterpiece made in Germany
Deep, warm sound characteristic
Sandblasted chakra symbol

INCLUDES Cover and gloves

2 GIANT TAM TAMs

SIZES **TT50:** 50" / 125 cm
TT60: 60" / 150 cm

MATERIAL Nickelsilver

TUNING **TT50:** F1 - F#1
TT60: D1 - E1

FEATURES Handcrafted masterpiece made in Germany
Deep, warm sound character with multi-layered overtones
Meets the highest musical demands

INCLUDES Gloves

3 FRAMED GONG STANDS

SIZES **TMGS-4:** Up to 50" gong size
TMGS-5: Up to 60" gong size

MATERIAL Anthracite powder coated steel

FEATURE Especially for bigger sized gongs

INCLUDES Sturdy wheels

4 DON CONREAUX EIGHT CORNERS OF HEAVEN MIRROR GONG

SIZE 32" / 80 cm

MATERIAL Nickelsilver

TUNING D2 - D#2

FEATURES Handcrafted masterpiece made in Germany
Exact fine tuning through hand-hammering
Printed ancient mysterious symbols on front and tuning info on the back
The eight runic glyphs represent the cycle of life
Mirror surface allows player to see himself, listeners or other gong players

INCLUDES Cover and gloves

4 DON CONREAUX
SIGNATURE GONG



32" / 80 cm
G32-DC-B

5 DESIGNED IN COOPERATION
WITH JENS ZYGAR



24" / 60 cm
G24-FOL

36" / 90 cm
G36-FOL

6 BASED ON THE CALCULATIONS OF
HANS COUSTO (THE COSMIC OCTAVE)



Sidereal Moon,
24" / 60 cm
G24-M-SI

Venus,
24" / 60 cm
G24-V

Neptune,
24" / 60 cm
G24-N

Synodic Moon,
24" / 60 cm
G24-M-SY

Uranus,
24" / 60 cm
G24-U

Sidereal Day,
28" / 70 cm
G28-E-SI

Jupiter,
28" / 70 cm
G28-J

Sedna,
28" / 70 cm
G28-SE



Chiron,
28" / 70 cm
G28-CH

Platonic Year,
28" / 70 cm
G28-E-PL

Saturn,
32" / 80 cm
G32-SA

Mars,
32" / 80 cm
G32-MA

Mercury,
32" / 80 cm
G32-ME

Earth Year/Om,
36" / 90 cm
G36-E

Sun,
36" / 90 cm
G36-S

5 FLOWER OF LIFE GONGS

SIZES **G24-FOL:** 24" / 60 cm
G36-FOL: 36" / 90 cm

MATERIAL Nickelsilver

TUNING **G24-FOL:** 128 Hz / C3
(A4/a' 440 Hz » 430.54 Hz)
G36-FOL: 64 Hz / C2
(A4/a' 440 Hz » 430.54 Hz)

FEATURES Handcrafted masterpiece made in Germany
Exact fine tuning through hand-hammering
Printed logo on front and tuning info on the back

INCLUDES Cover and gloves

6 PLANETARY TUNED GONGS

SIZES **G24:** 24" / 60 cm
G28: 28" / 70 cm
G32: 32" / 80 cm
G36: 36" / 90 cm

MATERIAL Nickelsilver

TUNING

CH: Chiron, 172.86 Hz / F2
(A4/a' 440 Hz » 435.58 Hz)
E: Earth Year/Om, 136.10 Hz / C#2
(A4/a' 440 Hz » 432.09 Hz)
E-PL: Platonic Year, 172.06 Hz / F2
(A4/a' 440 Hz » 433.56 Hz)
E-SI: Sidereal Day, 194.71 Hz / G2
(A4/a' 440 Hz » 437.11 Hz)
J: Jupiter, 183.58 Hz / F#2
(A4/a' 440 Hz » 436.63 Hz)
M-SI: Sidereal Moon, 227.43 Hz / A#2
(A4/a' 440 Hz » 429.33 Hz)
M-SY: Synodic Moon, 210.42 Hz / G#2
(A4/a' 440 Hz » 445.86 Hz)
MA: Mars, 144.72 Hz / D2
(A4/a' 440 Hz » 433.67 Hz)
ME: Mercury, 141.27 Hz / C#2
(A4/a' 440 Hz » 448.50 Hz)
N: Neptune, 211.44 Hz / G#2
(A4/a' 440 Hz » 448.03 Hz)

S: Sun, 126.22 Hz / B1 (H1)
(A4/a' 440 Hz » 449.80 Hz)
SA: Saturn, 147.85 Hz / D2
(A4/a' 440 Hz » 443.05 Hz)
SE: Sedna, 181.60 Hz / F#2
(A4/a' 440 Hz » 431.92 Hz)
U: Uranus, 207.36 Hz / G#2
(A4/a' 440 Hz » 439.38 Hz)
V: Venus, 221.23 Hz / A2
(A4/a' 440 Hz » 442.46 Hz)

FEATURES Handcrafted masterpiece made in Germany
Exact fine tuning through hand-hammering
Printed alchemical symbols for each planet
on front and tuning info on the back

INCLUDES Cover and gloves

Notice: Each gong is unique, variations in hand hammer patterns and coloration from the heating process may occur.

GONGS

1



24" / 60 cm
CHYY24

28" / 70 cm
CHYY28

32" / 80 cm
CHYY32

2



20" / 50 cm
CH-TT20

22" / 55 cm
CH-TT22

24" / 60 cm
CH-TT24

26" / 65 cm
CH-TT26

28" / 70 cm
CH-TT28



30" / 75 cm
CH-TT30

32" / 80 cm
CH-TT32

34" / 85 cm
CH-TT34

36" / 90 cm
CH-TT36

38" / 95 cm
CH-TT38

40" / 100 cm
CH-TT40

44" / 110 cm
CH-TT44

48" / 120 cm
CH-TT48

3



20" / 50 cm
WGYY20

22" / 55 cm
WGYY22

24" / 60 cm
WGYY24

26" / 65 cm
WGYY26

28" / 70 cm
WGYY28

30" / 75 cm
WGYY30

32" / 80 cm
WGYY32

1 CHAU TAM TAMS YIN & YANG

SIZES CHYY24: 24" / 60 cm
CHYY28: 28" / 70 cm
CHYY32: 32" / 80 cm

MATERIAL Special bronze alloy

FEATURES Handcrafted masterpiece made in China
Large sound characteristics
Blends well with other instruments

INCLUDES Beater and cover

SYMBOL Yin & Yang

2 CHAU TAM TAMS

SIZES CH-TT20: 20" / 50 cm
CH-TT22: 22" / 55 cm
CH-TT24: 24" / 60 cm
CH-TT26: 26" / 65 cm
CH-TT28: 28" / 70 cm
CH-TT30: 30" / 75 cm
CH-TT32: 32" / 80 cm
CH-TT34: 34" / 85 cm
CH-TT36: 36" / 90 cm
CH-TT38: 38" / 95 cm
CH-TT40: 40" / 100 cm
CH-TT44: 44" / 110 cm
CH-TT48: 48" / 120 cm

MATERIAL Special bronze alloy

FEATURES Handcrafted masterpiece made in China
Large sound characteristics
Blends well with other instruments
Printed logo and size info on the front

INCLUDES Beater and cover

3 WIND GONGS YIN & YANG

SIZES WGYY20: 20" / 50 cm
WGYY22: 22" / 55 cm
WGYY24: 24" / 60 cm
WGYY26: 26" / 65 cm
WGYY28: 28" / 70 cm
WGYY30: 30" / 75 cm
WGYY32: 32" / 80 cm

MATERIAL Special bronze alloy

FEATURES Handcrafted masterpiece made in China
Mainly low-pitched sound
Wave-like overtones

INCLUDES Beater and cover

SYMBOL Yin & Yang

4



20" / 50 cm
WGK20

22" / 55 cm
WGK22

24" / 60 cm
WGK24

26" / 65 cm
WGK26

28" / 70 cm
WGK28

30" / 75 cm
WGK30

32" / 80 cm
WGK32



5



12" / 30 cm
WG-TT12

16" / 40 cm
WG-TT16

18" / 45 cm
WG-TT18

20" / 50 cm
WG-TT20

22" / 55 cm
WG-TT22



24" / 60 cm
WG-TT24

26" / 65 cm
WG-TT26

28" / 70 cm
WG-TT28

30" / 75 cm
WG-TT30

32" / 80 cm
WG-TT32

36" / 90 cm
WG-TT36

40" / 100 cm
WG-TT40

44" / 110 cm
WG-TT44

48" / 120 cm
WG-TT48

4 WIND GONGS KUN

SIZES WGK20: 20" / 50 cm
WGK22: 22" / 55 cm
WGK24: 24" / 60 cm
WGK26: 26" / 65 cm
WGK28: 28" / 70 cm
WGK30: 30" / 75 cm
WGK32: 32" / 80 cm

MATERIAL Special bronze alloy
FEATURES Handcrafted masterpiece made in China
Mainly low-pitched sound
Wave-like overtones

INCLUDES Beater and cover
SYMBOL Kun

5 WIND GONGS

SIZES WG-TT12: 12" / 30 cm
WG-TT16: 16" / 40 cm
WG-TT18: 18" / 45 cm
WG-TT20: 20" / 50 cm
WG-TT22: 22" / 55 cm
WG-TT24: 24" / 60 cm
WG-TT26: 26" / 65 cm
WG-TT28: 28" / 70 cm
WG-TT30: 30" / 75 cm
WG-TT32: 32" / 80 cm
WG-TT36: 36" / 90 cm
WG-TT40: 40" / 100 cm
WG-TT44: 44" / 110 cm
WG-TT48: 48" / 120 cm

MATERIAL Special bronze alloy

FEATURES Handcrafted masterpiece made in China
Mainly low-pitched sound
Wave-like overtones

INCLUDES Printed logo and size info on the front
WG-TT12 - WG-TT18: Beater
WG-TT20 - WG-TT40: Beater and cover
WG-TT44 - WG-TT48: Beater

GONGS

1



22" / 55 cm
IG1

2



16" / 40 cm
WGFOL16

20" / 50 cm
WGFOL20

24" / 60 cm
WGFOL24

3

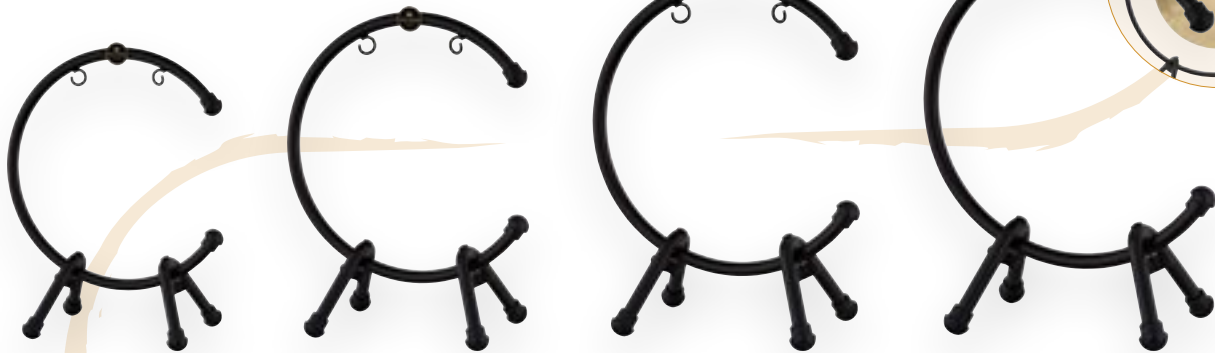

Small
TMTGS-S

Medium
TMTGS-M

Large
TMTGS-L

X-Large
TMTGS-XL

4



12" / 30 cm
OG-12

5



12" / 30 cm
WG-12

14.5" / 37 cm
WG-145

6



12.5" / 31.5 cm
TG-125

13" / 33 cm
TG-13

14" / 36 cm
TG-14

1 INDIAN PREMIUM WIND GONG

SIZE 22" / 55 cm
MATERIAL Special bronze alloy
FEATURES Handcrafted masterpiece made in India
Mainly low-pitched sound
Wave-like overtones
Hand engraved mantra
INCLUDES Table Gong Stand (TMTGS-L)

2 WIND GONGS FLOWER OF LIFE

SIZES **WGFOL16:** 16" / 40 cm
WGFOL20: 20" / 50 cm
WGFOL24: 24" / 60 cm
MATERIAL Special bronze alloy
FEATURES Handcrafted masterpiece made in China
Mainly low-pitched sound
Wave-like overtones
INCLUDES Beater
WGFOL20, WGFOL24: Cover
SYMBOL Flower of Life

3 TABLE GONG STANDS

SIZES **S:** Small; Up to 13" gong size
M: Medium; Up to 15" gong size
L: Large; Up to 22" gong size
XL: X-Large; Up to 26" gong size
MATERIAL Black powder coated steel
FEATURE Gong can be played in comfortable position on the floor or table
INCLUDES Hex key

4 OPERA GONG

SIZE 12" / 30 cm
MATERIAL Special bronze alloy
FEATURES Handcrafted masterpiece made in China
Descending pitch
Audible glissando effect with very short sustain
INCLUDES Beater

5 WHITE GONGS

SIZES **WG-12:** 12" / 30 cm
WG-145: 14.5" / 37 cm
MATERIAL Special bronze alloy
FEATURES Handcrafted masterpiece made in China
Powerful and splashy clear sound
Flat profile with bended rim
INCLUDES Beater

6 TIGER GONGS

SIZE **TG-125:** 12.5" / 31.5 cm
TG-13: 13" / 33 cm
TG-14: 14" / 36 cm
MATERIAL Special bronze alloy
FEATURES Handcrafted masterpiece made in China
Splashy sound
Pronounced bent-out shape
INCLUDES Beater

1



TMGS

2



TMGS-2

3



TMGS-2-G

5



TMGWM

4



TMGS-DS

6



TMGS-3

7



TMGS-3-G

8



Set
TMGS-W

9



Medium
TMWGS-M

Large
TMWGS-L

1 GONG STAND

SIZE Up to 32" gong size
MATERIAL Black powder coated steel
FEATURE Height-adjustable with locking system
INCLUDES Allen wrench

2 PRO GONG STAND

SIZE Up to 40" gong size
MATERIAL Black powder coated steel
FEATURES Especially for bigger sized gongs; Height-adjustable with locking system
INCLUDES Allen wrench

3 GONG HOLDER

SIZE Upper gong size up to 32"
Lower gong size up to 40"
MATERIAL Black powder coated steel
FEATURE For Pro Gong Stand only
INCLUDES Allen wrench

4 GONG DAMPENING SYSTEM

MATERIALS Black powder coated steel; Foam
FEATURES Height-adjustable to mute all gong sizes

5 GONG WALL MOUNT

SIZE Up to 40" gong size
MATERIAL Black powder coated steel
FEATURE Space-saving
INCLUDES Screws and dowels

6 FRAMED GONG STAND

SIZE Up to 40" gong size
MATERIAL Black powder coated steel
FEATURES Especially for bigger sized gongs; Height-adjustable with locking system
INCLUDES Allen wrench

7 FRAMED GONG HOLDER

SIZE Upper gong size up to 38"
Lower gong size up to 40"
MATERIAL Black powder coated steel
FEATURE For Framed Gong Stand only
INCLUDES Allen wrench

8 WHEELS FOR GONG STANDS

FEATURES For all TMGS Gong Stands; Set of four; For ease of mobility

9 WOOD GONG STANDS

SIZES **M:** Medium; Up to 34" gong size
L: Large; Up to 40" gong size
MATERIAL Beech wood

GONG MALLETS & BEATERS

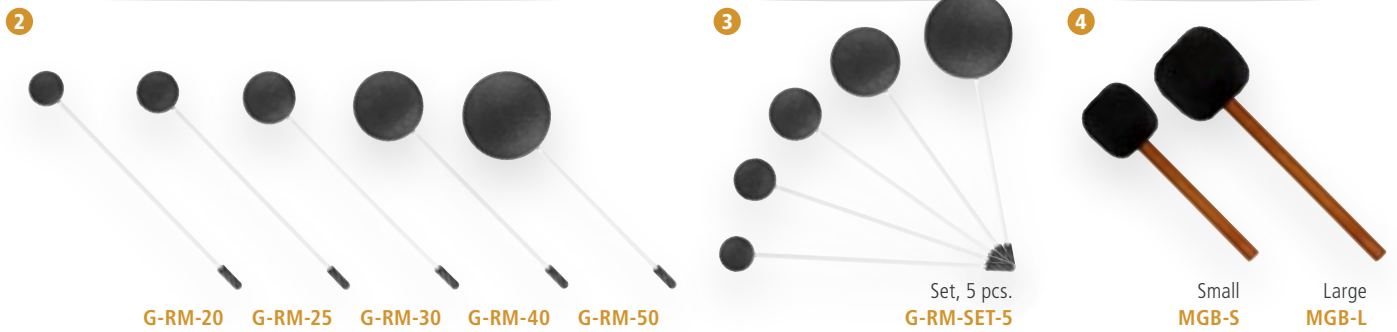

1 GONG MALLETS

DIMENSIONS **MGM-S:** Small (11.81" x 2.76" x 2.76"); 138 g; For gongs from 20" to 80"
MGM-M: Medium (13.58" x 3.15" x 3.15"); 222 g; For gongs from 22" to 80"
MGM-L: Large (15.55" x 3.94" x 3.94"); 374 g; For gongs from 24" to 80"

MATERIALS Beech wood; Synthetic fleece

FEATURE May be used also as a pair

COLOURS **C:** Chai
L: Lavender
PG: Pure Green
R: Rose
SP: Sea Petrol
ST: Sweet Tangerine

2 GONG RESONANT MALLET SETS

SIZES **G-RM-20:** 0.8"
G-RM-25: 1.0"
G-RM-30: 1.2"
G-RM-40: 1.6"
G-RM-50: 2.0"

MATERIAL Specially treated rubber ball

FEATURES Produces a gentle effect of the high and deepest low tones
 Explore therapeutic and atmospheric sounds with these mallets

3 GONG RESONANT MALLET SET

CONTAINS G-RM-20, G-RM-25, G-RM-30, G-RM-40, G-RM-50

4 GONG BEATERS

DIMENSIONS **MGB-S:** Small; +/- 220 g; For gongs up to 28"
MGB-L: Large; +/- 350 g; For gongs up to 40"

MATERIALS Sapele wood; Synthetic fleece

FEATURES To create a wide range of dynamics
 Heat-branded logo
MGB-S: Also perfect for singing bowls from 1,000 grams

5 TAM TAM BEATERS

DIMENSIONS **MTTB-24:** +/- 250 g; For 24" tam tams
MTTB-28: +/- 500 g; For 28" tam tams
MTTB-32: +/- 600 g; For 32" tam tams
MTTB-36: +/- 700 g; For 36" tam tams
MTTB-40: +/- 800 g; For 40" tam tams

MATERIALS Beech wood; Cotton plush; Sheep wool

7

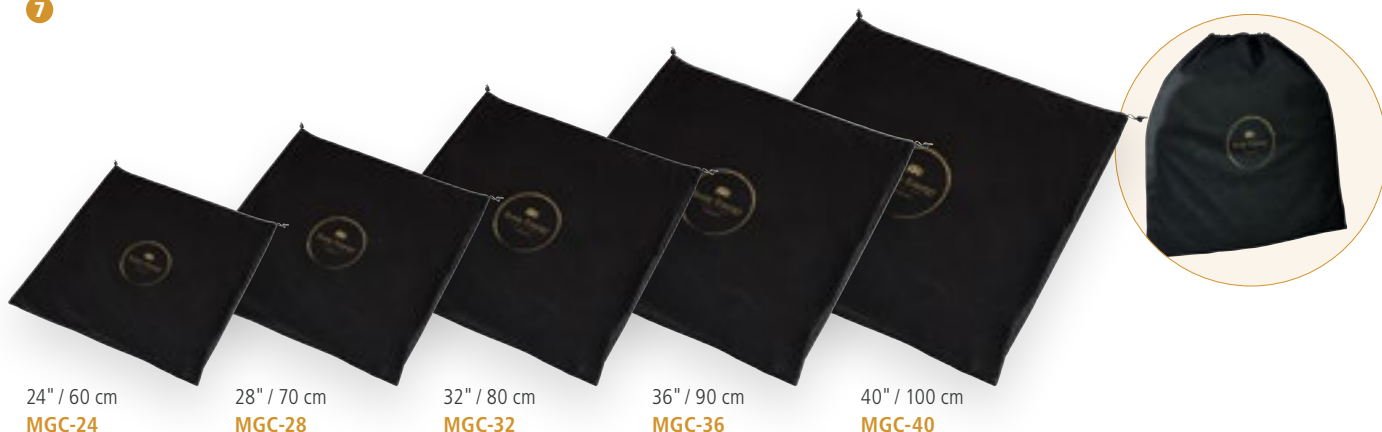

24" / 60 cm
MGC-24

28" / 70 cm
MGC-28

32" / 80 cm
MGC-32

36" / 90 cm
MGC-36

40" / 100 cm
MGC-40

8



24" / 60 cm
MGB-24

28" / 70 cm
MGB-28

32" / 80 cm
MGB-32

36" / 90 cm
MGB-36

38" / 95 cm
MGB-38

40" / 100 cm
MGB-40



9



G-HANDLE

11



MGP

12



MCCK-MCCL

10



GC-2428

GC-32

GC-3640

6 GONG & SINGING BOWL MALLETS

DIMENSIONS **MGM1:** 14.5" x 2.6"
For gongs from 20" to 80"
MGM2: 14.5" x 3.2"
For gongs from 22" to 80"

MATERIALS Maple; Synthetic fleece
FEATURES Hard synthetic core with soft synthetic fleece coating
For powerful and precise playing
Wrist strap

7 GONG COVERS

SIZES **MGC-24:** For 24" gongs
MGC-28: For 28" gongs
MGC-32: For 32" gongs
MGC-36: For 36" gongs
MGC-40: For 40" gongs
MATERIALS Inner material velvet;
Outer material polyester
FEATURE Protects against dust and fingerprints

8 GONG BAGS

SIZES **MGB-24:** For 24" gongs
MGB-28: For 28" gongs
MGB-32: For 32" gongs
MGB-36: For 36" gongs
MGB-38: For 38" gongs
MGB-40: For 40" gongs
MATERIALS Inner material velvet;
Outer material durable synthetic fleece
FEATURE Protects during transportation

9 GONG HANDLE

MATERIAL Beech wood
FEATURE For comfortable holding a gong

10 GONG CORDS

SIZES **GC-2428:** For gongs from 24" to 28"
GC-32: For 32" gongs
GC-3640: For gongs from 36" to 40"

11 GONG POLISH

SIZE 250 ml
FEATURE For polishing the surface of a gong

12 CARE KIT

FEATURES For cleaning and protecting the surface of a gong
Easy-to-use spray
INCLUDES Handling gloves

PLANETARY TUNED TUNING FORKS

1 BASED ON THE CALCULATIONS OF HANS COUSTO (THE COSMIC OCTAVE)



1 PLANETARY TUNED TUNING FORKS

SIZES	TF-CH: 7.3"	TF-ME: 7.9"
	TF-E: 8.0"	TF-N: 6.9"
	TF-E-GEO: 7.7"	TF-PL: 8.0"
	TF-E-HY: 7.6"	TF-S: 8.3"
	TF-E-PL: 7.4"	TF-SA: 7.8"
	TF-E-SI: 7.1"	TF-SE: 7.2"
	TF-E-SY: 7.1"	TF-SF: 6.5"
	TF-ER: 7.7"	TF-U: 6.9"
	TF-FOL: 8.3"	TF-V: 6.8"
	TF-J: 7.2"	TF-256: 6.4"
	TF-M-AR: 6.5"	
	TF-M-CU: 7.1"	
	TF-M-K: 6.6"	
	TF-M-L: 8.3"	
	TF-M-MC: 6.6"	
	TF-M-SI: 6.7"	
	TF-M-SP: 6.5"	
	TF-M-SY: 6.9"	
	TF-MA: 7.8"	

MATERIAL TUNING

Premium nickel plated steel
CH: Chiron, 172.86 Hz / F3
E: Earth Year/Om, 136.10 Hz / C#3
E-GEO: Geomagnetic Field, 149.74 Hz / D#3
E-HY: Hydrogen Gamma, 157.04 Hz / D#3
E-PL: Platonic Year, 172.06 Hz / F3
E-SI: Sidereal Day, 194.71 Hz / G3
E-SY: Synodic Day, 194.18 Hz / G3
ER: Eros, 154.66 Hz / D#3
FOL: Flower of Life, 128.00 Hz / C3
J: Jupiter, 183.58 Hz / F#3
M-AR: Apsidis' Rotation, 246.04 Hz / B3 (H3)
M-CU: Culmination Cycle, 187.61 Hz / F#3
M-K: Moon Knot, 234.16 Hz / A#3
M-L: Liliith, 123.02 Hz / B2 (H2)
M-MC: Metonic Cycle, 229.22 Hz / A#3
M-SI: Sidereal Moon, 227.43 Hz / A#3
M-SP: Saros' Period, 241.56 Hz / B3 (H3)
M-SY: Synodic Moon, 210.42 Hz / G#3
MA: Mars, 144.72 Hz / D3

ME: Mercury, 141.27 Hz / C#3
N: Neptune, 211.44 Hz / G#3
PL: Pluto, 140.64 Hz / C#3
S: Sun, 126.22 Hz / B2 (H2)
SA: Saturn, 147.85 Hz / D3
SE: Sedna, 181.60 Hz / F#3
SF: Schumann Resonance, 250.56 Hz / B3 (H3)
U: Uranus, 207.36 Hz / G#3
V: Venus, 221.23 Hz / A3
256: Master Fork 2, 256.00 Hz / C4
INCLUDES Cotton Bag

2 TUNING FORK DAY AND NIGHT SET

CONTAINS TF-E, TF-E-SY
INCLUDES Tuning Fork Holder (TF-HOLDER-2)
 2 x Cotton Bag

3 TUNING FORK CHAKRA SET

CONTAINS TF-E-PL (Crown Chakra), TF-V (Brow Chakra), TF-ME (Throat Chakra),

& ACCESSORIES



2
Set, 2 pcs.
TF-SET-2



3
Set, 7 pcs.
TF-SET-CHA-7



Set, 7 pcs.
TF-SET-CHA-7C



4
Set, 16 pcs.
TF-SET-16



5
Set, 27 pcs.
TF-SET-27



6
Set, 21 pcs.
TF-DISPLAY



7
Natural Pitch
TF-432
Standard Pitch
TF-440

PROFESSIONAL Mallet PERFECT FOR PLAYING TUNING FORKS (SEE PAGE 150)



SB-PM-SR-S



8
TF-HOLDER-1 **TF-HOLDER-2** **TF-HOLDER-7** **TF-HOLDER-16**
TF-HOLDER-27



9
TFC-M **TFC-L** **TFC-8** **TFC-16**

TF-E (Heart Chakra), TF-S (Navel Chakra), TF-M-SY (Sacral Chakra), TF-E-SY (Root Chakra)
INCLUDES 7 x Cotton Bag
TF-SET-CHA-7: Tuning Fork Holder (TF-HOLDER-7)
TF-SET-CHA-7C: Tuning Fork Case (TFC-8)

4 TUNING FORK SET, 16 PCS.
CONTAINS TF-CH, TF-E, TF-E-PL, TF-E-SI, TF-E-SY, TF-J, TF-M-SI, TF-M-SY, TF-MA, TF-ME, TF-N, TF-S, TF-SA, TF-SE, TF-U, TF-V
INCLUDES Tuning Fork Holder (TF-HOLDER-16)
16 x Cotton Bag

5 TUNING FORK SET, 27 PCS.
CONTAINS TF-CH, TF-E, TF-E-GEO, TF-E-HY, TF-E-PL, TF-E-SI, TF-E-SY, TF-FOL, TF-J, TF-M-AR, TF-M-CU, TF-M-K, TF-M-MC, TF-M-SI, TF-M-SP, TF-M-SY, TF-MA, TF-ME, TF-N,

TF-PL, TF-S, TF-SA, TF-SE, TF-SF, TF-U, TF-V, TF-256
INCLUDES Tuning Fork Holder (TF-HOLDER-27)
27 x Cotton Bag

6 TUNING FORK CHAKRA DISPLAY SET
CONTAINS 3 pcs. each: TF-E-PL (Crown Chakra), TF-V (Brow Chakra), TF-ME (Throat Chakra), TF-E (Heart Chakra), TF-S (Navel Chakra), TF-M-SY (Sacral Chakra), TF-E-SY (Root Chakra)
INCLUDES Wood Display
21 x Cotton Bag

7 NATURAL PITCH TUNING FORK & STANDARD PITCH TUNING FORK
SIZE 5.4"
MATERIAL Premium nickel plated steel
TUNING **TF-432:** 432 Hz (Natural Pitch)
TF-440: 440 Hz (Standard Pitch)

INCLUDES Cotton Bag
8 TUNING FORK HOLDERS
SIZES **TF-HOLDER-1:** For 1 tuning fork
TF-HOLDER-2: For 2 tuning forks
TF-HOLDER-7: For 7 tuning forks
TF-HOLDER-16: For 16 tuning forks
TF-HOLDER-27: For 27 tuning forks
MATERIAL Beech wood

9 TUNING FORK CASES
SIZES **TFC-M:** For max. 7.1" tuning forks
TFC-L: For max. 8.3" tuning forks
TFC-8: For 8 tuning forks
TFC-16: For 16 tuning forks
MATERIALS Inner material polyester
Outer material leatherette
FEATURE For safe and easy transportation

TUNING FORKS

PLANETARY TUNED THERAPY TUNING FORKS,

1 BASED ON THE CALCULATIONS OF HANS COUSTO (THE COSMIC OCTAVE)



1 PLANETARY TUNED THERAPY TUNING FORKS

SIZES	TTF-CH: 8.9"	TTF-ME: 9.4"
	TTF-E: 9.6"	TTF-N: 8.3"
	TTF-E-GEO: 9.3"	TTF-PL: 9.4"
	TTF-E-HY: 9.1"	TTF-S: 9.8"
	TTF-E-PL: 8.9"	TTF-SA: 9.3"
	TTF-E-SI: 8.5"	TTF-SE: 8.7"
	TTF-E-SY: 8.5"	TTF-SF: 7.8"
	TTF-ER: 9.1"	TTF-U: 8.3"
	TTF-J: 8.7"	TTF-V: 8.1"
	TTF-M-AR: 7.9"	TTF-128: 9.8"
	TTF-M-CU: 8.6"	TTF-256: 7.8"
	TTF-M-K: 8.0"	
	TTF-M-L: 9.9"	
	TTF-M-MC: 8.1"	
	TTF-M-SI: 8.1"	
	TTF-M-SP: 7.9"	
	TTF-M-SY: 8.3"	
	TTF-MA: 9.4"	

MATERIAL TUNING

Premium nickel plated steel
CH: Chiron, 172.86 Hz / F3
E: Earth Year/Om, 136.10 Hz / C#3
E-GEO: Geomagnetic Field, 149.74 Hz / D#3
E-HY: Hydrogen Gamma, 157.04 Hz / D#3
E-PL: Platonian Year, 172.06 Hz / F3
E-SI: Sidereal Day, 194.71 Hz / G3
E-SY: Synodic Day, 194.18 Hz / G3
ER: Eros, 154.66 Hz / D#3
J: Jupiter, 183.58 Hz / F#3
M-AR: Apsidis' Rotation, 246.04 Hz / E3
M-CU: Culmination Cycle, 187.61 Hz / F#3
M-K: Moon Knot, 234.16 Hz / A#3
M-L: Lilith, 123.02 Hz / B2 (H2)
M-MC: Metonic Cycle, 229.22 Hz / A#3
M-SI: Sidereal Moon, 227.43 Hz / A#3
M-SP: Saros' Period, 241.56 Hz / B3 (H3)
M-SY: Synodic Moon, 210.42 Hz / G#3
MA: Mars, 144.72 Hz / D3
ME: Mercury, 141.27 Hz / C#3

N: Neptune, 211.44 Hz / G#3
PL: Pluto, 140.64 Hz / C#3
S: Sun, 126.22 Hz / B2 (H2)
SA: Saturn, 147.85 Hz / D3
SE: Sedna, 181.60 Hz / F#3
SF: Schumann Resonance, 250.56 Hz / B3 (H3)
U: Uranus, 207.36 Hz / G#3
V: Venus, 221.23 Hz / A3
128: Master Fork, 128.00 Hz / C3
256: Master Fork 2, 256.00 Hz / C4

FEATURES
 Handcrafted masterpiece made in Germany
 Ergonomic shaped cork handle
 Engraved logo and tuning info

INCLUDES
 Cotton Bag

2 THERAPY TUNING FORK DAY AND NIGHT SET

CONTAINS TTF-E, TTF-E-SY
INCLUDES Therapy Tuning Fork Holder (TTF-HOLDER-2); 2 x Cotton Bag



ACCESSORIES & CRYSTAL TUNING FORKS

Sonic Energy
Collection



Set, 2 pcs.
TTF-SET-2

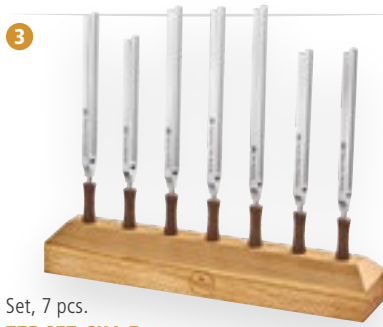

Set, 7 pcs.
TTF-SET-CHA-7



Set, 16 pcs.
TTF-SET-16



Set, 27 pcs.
TTF-SET-27



Natural Pitch
TTF-432 Standard Pitch
TTF-440



CRYSTAL SINGING BOWL Mallet
PERFECT FOR PLAYING CRYSTAL
TUNING FORKS (SEE PAGE 144)
CSBM



TTF-HOLDER-1 **TTF-HOLDER-2** **TTF-HOLDER-7** **TTF-HOLDER-16** **TTF-HOLDER-27**

8 CRYSTAL



Note C4, 15" length **CTF440C20** Note F4, 15" length **CTF440F20** Note C3, 17.7" length **CTF440C16** Note F3, 17.7" length **CTF440F16**



TUNING FORKS

3 THERAPY TUNING FORK CHAKRA SET

CONTAINS TTF-E-PL (Crown Chakra), TTF-V (Brow Chakra), TTF-ME (Throat Chakra), TTF-E (Heart Chakra), TTF-S (Navel Chakra), TTF-M-SY (Sacral Chakra), TTF-E-SY (Root Chakra)
INCLUDES Therapy Tuning Fork Holder (TTF-HOLDER-7); 7 x Cotton Bag

4 THERAPY TUNING FORK SET, 16 PCS.

CONTAINS TTF-CH, TTF-E, TTF-E-PL, TTF-E-SI, TTF-E-SY, TTF-J, TTF-M-SI, TTF-M-SY, TTF-MA, TTF-ME, TTF-N, TTF-S, TTF-SA, TTF-SE, TTF-U, TTF-V
INCLUDES Therapy Tuning Fork Holder (TTF-HOLDER-16); 16 x Cotton Bag

5 THERAPY TUNING FORK SET, 27 PCS.

CONTAINS TTF-CH, TTF-E, TTF-E-GEO, TTF-E-HY, TTF-E-PL, TTF-E-SI, TTF-E-SY, TTF-J,

TTF-M-AR, TTF-M-CU, TTF-M-K, TTF-M-MC, TTF-M-SI, TTF-M-SP, TTF-M-SY, TTF-MA, TTF-ME, TTF-N, TTF-PL, TTF-S, TTF-SA, TTF-SE, TTF-SF, TTF-U, TTF-V, TTF-128, TTF-256
INCLUDES Therapy Tuning Fork Holder (TTF-HOLDER-27); 27 x Cotton Bag

6 NATURAL PITCH THERAPY TUNING FORK & STANDARD PITCH THERAPY TUNING FORK

SIZE 6.5"
MATERIAL Premium nickel plated steel
TUNING **TTF-432**: 432 Hz (Natural Pitch)
TTF-440: 440 Hz (Standard Pitch)
INCLUDES Cotton Bag

7 THERAPY TUNING FORK HOLDERS

SIZES **TTF-HOLDER-1**: For 1 tuning fork
TTF-HOLDER-2: For 2 tuning forks
TTF-HOLDER-7: For 7 tuning forks

TTF-HOLDER-16: For 16 tuning forks
TTF-HOLDER-27: For 27 tuning forks

MATERIAL Beech wood

8 CRYSTAL TUNING FORKS

SIZES **CTF440C20, CTF440F20**: 0.79" / 20 mm diameter, 15" / 38 cm length
CTF440C16, CTF440F16: 0.63" / 16 mm diameter, 17.7" / 45 cm length

MATERIAL Gemstone (Quartz)
TUNING A4/a' 440 Hz

CTF440C20: C4 ~261.63 Hz
CTF440F20: F4 ~349.23 Hz
CTF440C16: C3 ~130.81 Hz
CTF440F16: F3 ~174.61 Hz

FEATURES Perfect for therapy and relaxation
Extremely long-lasting resonance
Pure and attractive crystal material

MEINL SENSORY HANDPANS

1



D Kurd, 9 notes
HPSTL90

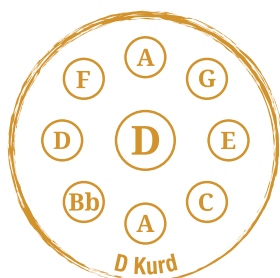

ETHEREAL SOUNDS



VINTAGE GOLD FINISH

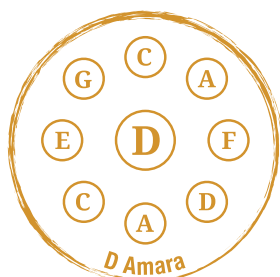

D Amara, 9 notes
HPSTL91

NEW



C# Minor, 9 notes
HPSTL92

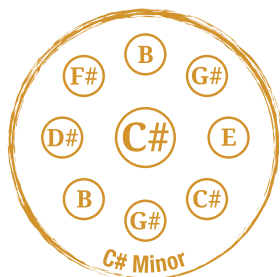

PADDED CARRYING BAG



1 MEINL SENSORY HANDPANS

- SIZE** 22" diameter, 9" height
- MATERIAL** Stainless steel
- TUNING** **HPSTL90:** A4/a' 440 Hz
D Kurd D3/ A3, Bb3, C4, D4, E4, F4, G4, A4 (9 notes)
HPSTL91: A4/a' 440 Hz
D Amara D3/ A3, C4, D4, E4, F4, G4, A4, C5 (9 notes)
HPSTL92: A4/a' 432 Hz
Cis Minor C#3/ G#3, B3, C#4, D#4, E4, F#4, G#4, B4 (9 notes)
HPSTL100: A4/a' 440 Hz
D Kurd D3/ A3, Bb3, C4, D4, E4, F4, G4, A4, C5 (10 notes)
HPSTL101: A4/a' 440 Hz
D Amara D3/ G3, A3, C4, D4, E4, F4, G4, A4, C5 (10 notes)

- FEATURES** Handcrafted masterpiece
Pure soft sound with long sustain
Perfect for both meditative and percussive playing
Two sound holes: One, which faces the player and one, which faces the audience
Two removable sound tubes for more sound options
Durable stainless steel material
Harmonic and balanced tones
Lasered logo and tuning
- INCLUDES** Padded carrying bag, stainless steel protection cover, soft velvet bag, gloves and two sound tubes
- COLOUR** Vintage Gold



D Kurd, 10 notes
HPSTL100

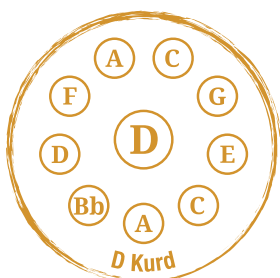

MORE SOUND OPTIONS



RESISTANT PROTECTION COVER

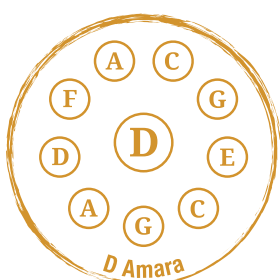

NEW



D Amara, 10 notes
HPSTL101



HANDPANS

STAINLESS STEEL HANDPAN CARE SET
PERFECT FOR SENSORY HANDPANS
(SEE PAGE 167)



SSHPCS



HARMONIC ART HANDPANS

1



Natural D, 8 notes
HD1



Natural Prime F, 8 notes
HD1-F



Equinox E, 8 notes
HD2



Equinox E, 8 notes
HD2-432

432 Hz



Raga Desya Todi D#, 8 notes
HD3



Akebono F, 8 notes
HD4



Integral D, 8 notes
HD5



Expert D#, 8 notes
HD6-EXPERT



Free Integral C#, 8 notes
HD7



1 MEINL HARMONIC ART HANDPANS

SIZE 21.5" diameter, 10" height

MATERIAL Nitrided steel

TUNING 8 notes

HD1: A4/a' 440 Hz

Natural D/ A, A#, C, D, F, G, A

HD1-F: A4/a' 440 Hz

Natural Prime F/ A, A#, C, D, F, G, A

HD2: A4/a' 440 Hz

Equinox E/ G, B, C, D, E, F#, G

HD2-432: A4/a' 432 Hz

Equinox E/ G, B, C, D, E, F#, G

HD3: A4/a' 440 Hz

Raga Desya Todi D#/ G, A#, C, D, D#, F, G

HD4: A4/a' 440 Hz

Akebono F/ A#, C, C#, D#, F, F#, A#

HD5: A4/a' 440 Hz

Integral D/ A, A#, C, D, E, F, A

HD6-EXPERT: A4/a' 440 Hz

Expert D#/ G#, A#, B, C#, D#, F#, G#

HD7: A4/a' 440 Hz

Free Integral C#/ G#, A, B, C#, D#, E, G#

FEATURES

Handcrafted masterpiece

Pure soft sound with long sustain

Perfect for both meditative and

percussive playing

INCLUDES

Padded carrying bag, steel protection

cover and gloves

COLOUR

Black



HANDPAN ACCESSORIES



2

EV



3

SEPU



4

NEW

HPC

HPP

SSHPP



NEW

Set, 2 pcs.
HPCS

Set, 2 pcs.
SSHPCS

6

HP-CW



9

HPWS2



HANDPANS



5

HPS-S

HPS



7

HPR

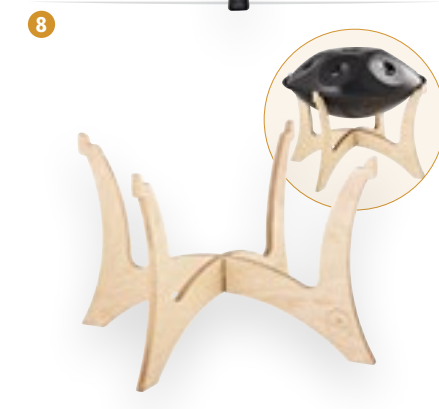

8

HPWS

2 HANDPAN HARDCASE

SIZE 23.5" diameter, 12" height
MATERIALS Special molded ABS and EVA material
FEATURES Ergonomic handle; Rain waterproof; Removable shoulder straps
INCLUDES Pocket Bag
Carabiner

3 MAGNETIC PICKUP

FEATURES Magnetic; Piezo pickup; Integrated volume regulator; 6.3 mm input jack; 2.5 m long cable

4 HANDPAN CARE

SIZE 150 ml
PRODUCTS **HPC:** Handpan Cleaner
HPP: Nitrided Steel Handpan Protectant
HPCS: Nitrided Steel Handpan Care Set
SSHPP: Stainless Steel Handpan Protectant
SSHPCS: Stainless Steel Handpan Care Set
CONTAINS **HPCS:** 1 x HPP, 1 x HPC
SSHPCS: 1 x SSHPP, 1 x HPC
FEATURES Corrosion protection; Made in Germany
INCLUDES **HPCS, SSHPCS:** Two microfiber cloths

5 METALLIC HANDPAN & TONGUE DRUM STANDS

SIZES **HPS-S:** Height-adjustable (22" - 27")
HPS: Height-adjustable (28" - 39")
MATERIAL Black powder coated steel
FEATURE For Handpans and Steel Tongue Drums

6 HANDPAN CARE WAX

SIZE 36 ml
FEATURES Designed for any unlacquered handpan; Prevents unwanted development of rust

7 WOOD HANDPAN REST

MATERIAL Baltic Birch (*Betula pendula*)
FEATURES For easy storage and presentation; Fits for all Meinl handpans

8 WOOD HANDPAN STAND

MATERIAL Baltic Birch (*Betula pendula*)
FEATURE Fits for handpans with ~21.5" diameter

9 INCLINED WOOD HANDPAN STAND

MATERIAL Baltic Birch (*Betula pendula*)
FEATURE Fits for handpans with ~22" diameter

STEEL TONGUE DRUMS

1

NEW



A Major, Purple
PSTD1PLF

NEW



A Major, Navy Blue
PSTD2NBVF

NEW



A Major, Gold
PSTD3GOM



2



C Major, Black
MSTD1BK



A Major, Navy Blue
MSTD2NB



B Major, Gold
MSTD3G

3



F Minor, Black
SSTD1BK



G Minor, Navy Blue
SSTD2NB



1 POCKET STEEL TONGUE DRUMS

SIZE 3" diameter, 1.85" height
MATERIAL Coated stainless steel
TUNING A Major A5, B5, C#6, E6, F#6, A6
FEATURES Great gift idea; Soft and soothing sound; Pre-tuned scale; Perfect for takeaway
PSTD1PLF: Lasered Lotus Flower design
PSTD2NBVF: Lasered Venus Flower design
PSTD3GOM: Lasered OM design
INCLUDES Wooden mallet with rubber head
COLOURS **PSTD1PLF:** Purple
PSTD2NBVF: Navy Blue
PSTD3GOM: Gold

2 MINI STEEL TONGUE DRUMS

SIZE 6" diameter, 2.55" height
MATERIAL Coated stainless steel
TUNING **MSTD1BK:** C Major
C5, D5, E5, G5, A5, C6

MSTD2NB: A Major
A4, B4, C#5, E5, F#5, A5
MSTD3G: B Major
B4, C#5, D#5, F#5, G#5, B5
FEATURES Miniature size Steel Tongue Drum; Soft and soothing sound; Pre-tuned scale; Great for yoga studios, sound therapy, classrooms or your coffee table
INCLUDES Bag and wooden mallet pair with rubber heads
COLOURS **BK:** Black
G: Gold
NB: Navy Blue

3 SMALL STEEL TONGUE DRUMS

SIZE 7" diameter, 2.56" height
MATERIAL Coated stainless steel
TUNING **SSTD1BK:** F Minor
F4, Ab4, Bb4, C5, Eb5, F5, Ab5, Bb5

SSTD2NB: G Minor
G4, Bb4, C5, D5, F5, G5, Bb5, C6
FEATURES Portable size Steel Tongue Drum; Soft and soothing sound; Pre-tuned scale; Great for yoga studios, sound therapy, classrooms or your coffee table
INCLUDES Bag and wooden mallet pair with rubber heads
COLOURS **BK:** Black
NB: Navy Blue

4 STEEL TONGUE DRUMS

SIZE 12" diameter, 6.5" height
MATERIAL Coated steel
TUNING **STD1:** A Minor
A3, C4, D4, E4, G4, A4, C5, D5
STD2: A Akebono
A3, B3, C4, E4, F4, A4, B4, C5
STD3: G Major
G3, A3, B3, D4, E4, G4, A4, B4

4



A Minor, Black
STD1BK



A Akebono, Black
STD2BK



G Major, Black
STD3BK



A Minor, Vintage Brown
STD1VB



A Akebono, Vintage Brown
STD2VB



G Major, Vintage Brown
STD3VB



G Minor, Pearl Grey
STD4PG

5

NEW



D Kurd, Black
OSTD1BK

NEW



D Kurd, Black
OSTD1BKE

NEW



D Amara, Navy Blue
OSTD2NB

NEW



D Amara, Navy Blue
OSTD2NBE

6



STDB

METALLIC HANDPAN &
TONGUE DRUM STANDS
(SEE PAGE 167)



HPS-5

STD4: G Minor
G3, Bb3, C4, D4, F4, G4, Bb4, C5
FEATURES Rich, full and soothing sound; Pre-tuned scale; Great for yoga studios, sound therapy, classrooms or your coffee table
INCLUDES Carrying bag and Steel Tongue Drum Mallet pair with soft rubber tips (STDB)
COLOURS **BK:** Black
PG: Pearl Grey
VB: Vintage Brown

5 OCTAVE STEEL TONGUE DRUMS

SIZE 16" diameter, 6.4" height
MATERIAL Coated stainless steel
TUNING **OSTD1:** D Kurd
D3/ A3, Bb3, C4, D4, E4, F4, G4, A4
OSTD2: D Amara
D3/ A3, C4, D4, E4, F4, G4, A4, C5

FEATURES One bass note plus eight additional octavated notes; Pre-tuned scale; Rich, space-filling and meditative sound; Decorative nylon cord; Non-slip silicone feet; Removable silicone plug
OSTD1BKE, OSTD2NBE: Lasered floral design
INCLUDES Carrying bag and wooden mallet pair with rubber heads
COLOURS **BK:** Black
NB: Navy Blue

6 STEEL TONGUE DRUM MALLETS

SIZE 11.25"
FEATURES Designed to elicit full-bodied, rich tones; Textured grips provide firm control; Perfect for the Meinl Steel Tongue Drum STD models; Soft rubber tip



KALIMBAS

1



21 notes,
Black Walnut
KL2101S



17 notes,
Black Walnut
KL1701S



17 notes,
Sapele
KL1702S



17 notes,
Acacia
KL1703S



17 notes,
Maple
KL1704S



10 notes,
Black Walnut
KL1001TOL



10 notes,
Zambesi Redwood
KL1002FOL

2



8 notes, Sapele
KL8MINI



8 notes, Maple
KL801S



8 notes, Black Walnut
KL801TOL



8 notes, Red Zebra wood
KL802FOL

1 SOLID KALIMBAS

SIZES **KL2101S:** 5.5" W x 7.1" D
KL1701S: 5.4" W x 7.5" D
KL1702S: 5.2" W x 7.3" D
KL1703S: 5.1" W x 7.1" D
KL1704S: 5.1" W x 7.1" D
KL1001TOL: 5.0" W x 6.7" D
KL1002FOL: 5.0" W x 6.7" D
KL801S: 2.8" W x 4.3" D

MATERIALS Chrome plated steel
KL2101S, KL1701S, KL1001TOL: Black Walnut
KL1702S: Sapele
KL1703S: Acacia
KL1704S, KL801S: Maple
KL1002FOL: Zambesi Redwood

TUNING C Major
KL2101S: d^{''}, b^{''}, g^{''}, e^{''}, c^{''}, a, f, d, B, G, F, A, c, e, g, b, d, f, a^{''}, c^{''}, e^{''} (21 notes)

KL1701S, KL1702S, KL1703S, KL1704S: d^{''}, b^{''}, g^{''}, e^{''}, c^{''}, a, f, d, c, e, g, b, d^{''}, f^{''}, a^{''}, c^{''}, e^{''} (17 notes)
KL1001TOL, KL1002FOL: e^{''}, c^{''}, a, f, d, c, e, g, b, d^{''} (10 notes)
KL801S: a^{''}, e^{''}, c^{''}, g, a, d^{''}, g^{''}, c^{''} (8 notes)

FEATURES Solid body
Harmonious tone sequence
KL1001TOL: High-quality relief "Tree of Life"
KL1002FOL: High-quality relief "Flower of Life"

INCLUDES Linen bag; Microfiber cloth; Tuning hammer
KL2101S, KL1701S, KL1702S, KL1703S, KL1704S, KL1001TOL, KL1002FOL: Case

FINISHES **KL2101S, KL1701S, KL1702S, KL1703S, KL1704S, KL801S:** Gloss
KL1001TOL, KL1002FOL: Matte

2 MINI KALIMBAS

SIZES **KL8MINI:** 2.0" W x 2.8" D
KL801TOL: 2.2" W x 2.9" D
KL802FOL: 2.2" W x 2.9" D

MATERIALS Chrome plated steel
KL8MINI: Sapele
KL801TOL: Black Walnut
KL802FOL: Red Zebra wood

TUNING C Major
c^{''}, a, f, d, c, e, g, b^{''} (8 notes)

FEATURES Solid body
Harmonious tone sequence
Excellent gift idea
KL801TOL: High-quality relief "Tree of Life"
KL802FOL: High-quality relief "Flower of Life"

INCLUDES **KL8MINI:** Ribbon
KL8MINI: Gloss
KL801TOL, KL802FOL: Matte

3



17 notes,
Maple & Acacia
KL1706H



17 notes,
Acacia
KL1707H



17 notes,
Mahogany
KL1708H



17 notes,
Maple
KL1709H



10 notes,
Mahogany
KL1008H



10 notes,
Maple
KL1009H



4



17 notes,
Acacia
KL1705H



5



17 notes,
Acacia
PKL1707H



17 notes,
Mahogany
PKL1708H



17 notes,
Maple
PKL1709H

3 SOUND HOLE KALIMBAS

- SIZES** **KL1706H, KL1707H, KL1708H, KL1709H:** 5.3" W x 7.3" D
KL1008H: 4.9" W x 6.7" D
KL1009H: 4.9" W x 6.7" D
- MATERIALS** Chrome plated steel
KL1706H: Maple, Acacia
KL1707H: Acacia
KL1708H, KL1008H: Mahogany
KL1709H, KL1009H: Maple
- TUNING** C Major
KL1706H, KL1707H, KL1708H, KL1709H: d'', b', g', e', c', a, f, d, c, e, g, b, d', f', a', c'', e'' (17 notes)
KL1008H, KL1009H: e', c', a, f, d, c, e, g, b, d' (10 notes)
- FEATURES** Hollowed resonating body
Harmonious tone sequence
- INCLUDES** Case; Linen bag; Microfiber cloth; Tuning hammer

- FINISHES** **KL1706H, KL1707H, KL1709H, KL1009H:** Gloss
KL1708H, KL1008H: Matte

4 WAH-WAH KALIMBA

- SIZE** 5.3" W x 7.3" D
- MATERIALS** Chrome plated steel
Acacia
- TUNING** C Major
d'', b', g', e', c', a, f, d, c, e, g, b, d', f', a', c'', e'' (17 notes)
- FEATURES** Hollowed resonating body
Harmonious tone sequence
Wah-wah effect
- INCLUDES** Case; Linen bag; Microfiber cloth; Tuning hammer
- FINISH** Gloss

5 SOUNDHOLE PICKUP KALIMBAS

- SIZE** 5.3" W x 7.5" D
- MATERIALS** Chrome plated steel
PKL1707H: Acacia
PKL1708H: Mahogany
PKL1709H: Maple
- TUNING** C Major
d'', b', g', e', c', a, f, d, c, e, g, b, d', f', a', c'', e'' (17 notes)
- FEATURES** Hollowed resonating body
Harmonious tone sequence
Built-in pickup
Red markings for visual orientation
- INCLUDES** Case; Linen bag; Microfiber cloth; Tuning hammer
- FINISHES** **PKL1707H, PKL1709H:** Gloss
PKL1708H: Matte

MEDITATION FLOW CHIMES, HAND CHIMES,

1 NEW



MFC10DMAB



MFC10GMAB

440 Hz

2 NEW

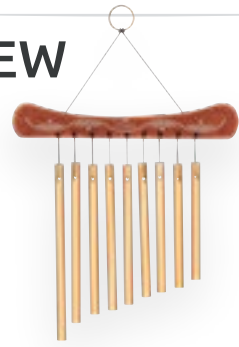

HC9B

3 NEW



HIB18BK

4 NEW



SC29B



SC29S



MFC10CMIBK



MFC10EMIBK

432 Hz

1 MEDITATION FLOW CHIMES

SIZES MFC10DMAB: 35" / 88 cm height
MFC10GMAB: 35" / 88 cm height
MFC10CMIBK: 38" / 95 cm height
MFC10EMIBK: 38" / 95 cm height

MATERIALS Ash wood, aluminum, leather, nylon cord

TUNING 10 notes
MFC10DMAB: A4/a' 440 Hz; D Major D5, E5, F#5, A5, B5, D6, E6, F#6, A6, B6
MFC10GMAB: A4/a' 440 Hz; G Major G4, A4, B4, D5, E5, G5, A5, B5, D6, E6
MFC10CMIBK: A4/a' 432 Hz; C Minor C5, Eb5, F5, G5, Bb5, C6, Eb6, F6, G6, Bb6
MFC10EMIBK: A4/a' 432 Hz; E Minor E4, G4, A4, B4, D5, E5, G5, A5, B5, D6

FEATURES Perfect for gentle swaying, circling, spinning and twirling; Calming and balancing effect on body, mind and spirit; Playable from both sides; Long-lasting resonance; Integrated holder for mallet

INCLUDES Carrying bag with a flocked velvet cloth and adjustable shoulder strap; Mallet with felt tip (SB-PM-HFL-L)

FINISHES B: Bronze
BK: Black

2 HAND CHIME

SIZE 14" / 36 cm height

MATERIALS Ash wood, aluminum, nylon cord

FEATURES Clear, sweet sparkling sound; For meditation, relaxation, therapy applications, or as a sound effect; 9 solid bronze aluminum bars; Curved wooden top with wind design; Suspension ring

FINISH B: Bronze

3 HANGING IRON BELL

SIZE 18" / 45 cm height

MATERIALS Iron, plastic, nylon cord

TUNING B#5 - D#5

FEATURES Soft and soothing sound; Deep-toned; Long-lasting resonance; For meditation, relaxation, therapy applications, or as sound effect; Leaf symbol at the bottom; Height-adjustable pendulum; Suspension ring

FINISH BK: Matte black

4 WIND CHIMES 4 5 6 7 8

FEATURES Long-lasting resonance; For meditation, relaxation, therapy applications, or even for decorating; Suspension ring

4 SPIRAL CHIMES

SIZE 29" / 73 cm height

MATERIALS Ash wood, aluminum, nylon cord

FEATURES High-pitched, sparkling sound; 16 aluminum bars; Round wooden top

FINISHES B: Bronze
S: Silver

BELL & WIND CHIMES



FOLMC36B

FOLMC36BK

HMC36B

HMC36BK

TOLMC36B

TOLMC36BK

CMC25S

BAMC29S



MMC32B

MMC44B

MMC32S

MMC44S

MMC35S

MMC49S

5 MEDITATION CHIMES

SIZE 36" / 90 cm height
MATERIALS Ash wood, aluminum, plastic, nylon cord
TUNING A4/a' 432 Hz
 G#5, A5, B5, D6, E6
FEATURES Soft and soothing sound;
 5 aluminum bars; Round wooden top;
 Height-adjustable pendulum
SYMBOLS **FOL:** Flower of Life
H: Hamsa
TOL: Tree of Life
FINISHES **B:** Bronze
BK: Matte black

6 CHAKRA MEDITATION CHIME

SIZE 25" / 64 cm height
MATERIALS Ash wood, aluminum, plastic, nylon cord
TUNING A4/a' 432 Hz
 D6, E6, F#6, B6, D7

FEATURES Bright, activating sound; 7 different
 coloured chakra stones; 5 silver
 aluminum bars; Round wooden top
FINISH **S:** Silver

7 BLUE AGATE MEDITATION CHIME

SIZE 29" / 73 cm height
MATERIALS Ash wood, aluminum, plastic, nylon cord,
 Agate
TUNING A4/a' 432 Hz
 F6, G6, A6, C7, D7, F7
FEATURES Clear and cheerful sound; 6 silver
 aluminum bars; Blue Agate stone at the
 bottom; Round wooden top; Height-
 adjustable pendulum
FINISH **S:** Silver

8 MOON MEDITATION CHIMES

SIZES **MMC32:** 32" / 80 cm height
MMC35: 35" / 88 cm height

MMC44: 44" / 110 cm height

MMC49: 49" / 125 cm height

MATERIALS **MMC32, MMC44:**
 Iron, aluminum, plastic, nylon cord
MMC35, MMC49:

Ash wood, aluminum, plastic, nylon cord
TUNING A4/a' 432 Hz
MMC32: G5, A5, B5, D6, E6, G6
MMC35: C6
MMC44: B4, C#5, D#5, F#5, G#5, B5
MMC49: C5

FEATURES Soft and soothing sound; Moon symbol at
 the bottom; Height-adjustable pendulum

MMC32, MMC44:
 6 aluminum bars; Black round arch top
MMC35, MMC49:

1 aluminum bar; Wooden curved top

FINISHES **B:** Bronze
S: Silver

PLANETARY TUNED ENERGY CHIMES

1 BASED ON THE CALCULATIONS OF HANS COUSTO (THE COSMIC OCTAVE)

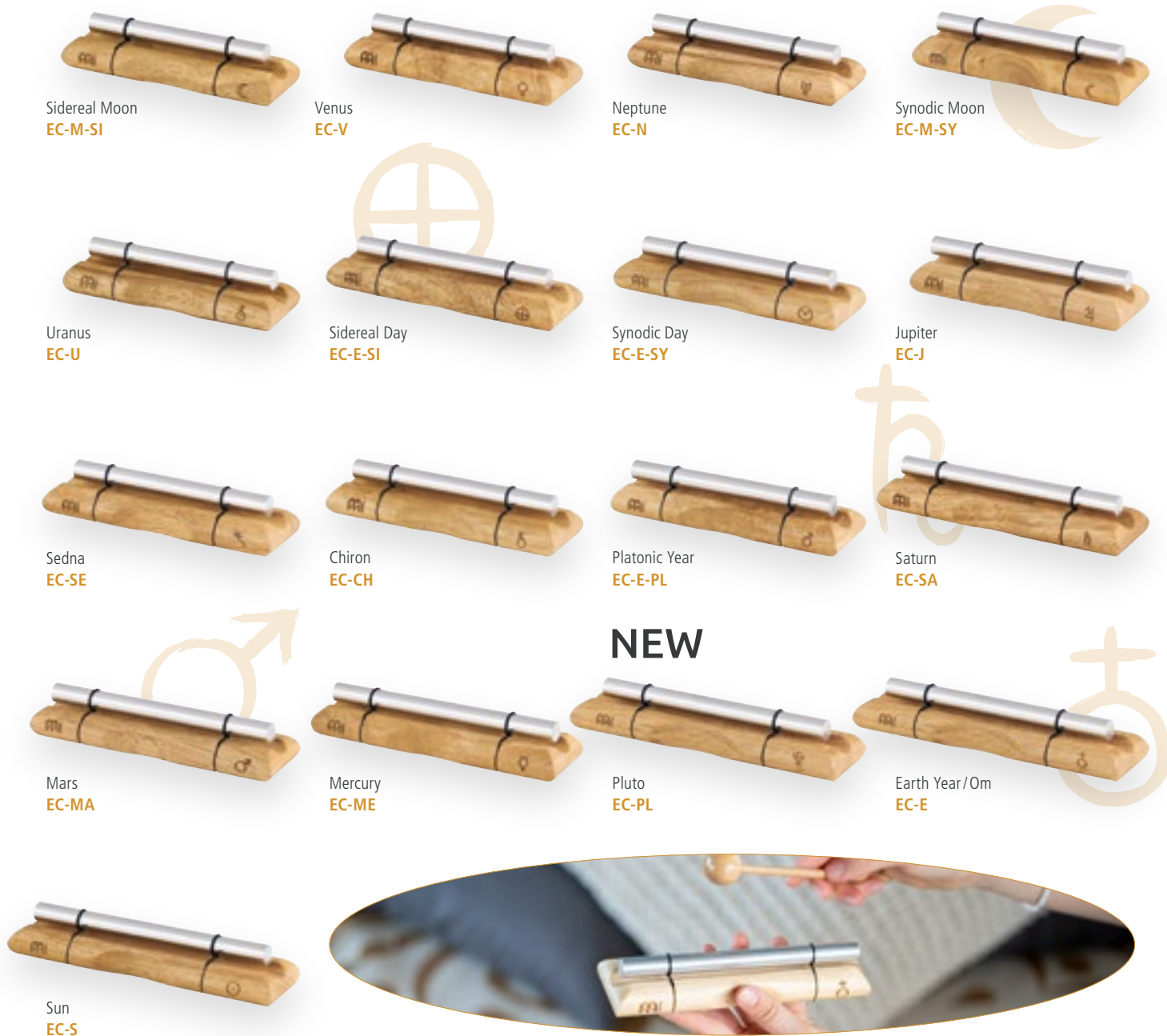

1 PLANETARY TUNED ENERGY CHIMES

MATERIAL Silver anodized aluminum alloy
TUNING **CH:** Chiron, 2765.76 Hz / F7
E: Earth Year/Om, 2177.60 Hz / C#7
E-PL: Platonic Year, 2752.96 Hz / F7
E-SI: Sidereal Day, 3115.36 Hz / G7
E-SY: Synodic Day, 3106.88 Hz / G7
J: Jupiter, 2937.28 Hz / F#7
M-SI: Sidereal Moon, 3638.88 Hz / A#7
M-SY: Synodic Moon, 3366.72 Hz / G#7
MA: Mars, 2315.52 Hz / D7
ME: Mercury, 2260.32 Hz / C#7
N: Neptune, 3383.04 Hz / G#7
PL: Pluto, 2250.24 Hz / C#7
S: Sun, 2019.52 Hz / B6
SA: Saturn, 2365.60 Hz / D7
SE: Sedna, 2905.60 Hz / F#7
U: Uranus, 3317.76 Hz / G#7
V: Venus, 3539.68 Hz / A7

FEATURES Handcrafted masterpiece made in Thailand
 Exact fine tuning
 Heat-branded logo and tuning info
INCLUDES Wooden beater

2 ENERGY CHIMES 16-PIECE SET-UP

CONTAINS EC-CH, EC-E, EC-E-PL, EC-E-SI, EC-E-SY, EC-J, EC-M-SI, EC-M-SY, EC-MA, EC-ME, EC-N, EC-S, EC-SA, EC-SE, EC-U, EC-V
INCLUDES 16 x wooden beater

3 ENERGY CHIMES CHAKRA SET

CONTAINS EC-E-PL (Crown Chakra), EC-V (Brow Chakra), EC-ME (Throat Chakra), EC-E (Heart Chakra), EC-S (Navel Chakra), EC-M-SY (Sacral Chakra), EC-E-SY (Root Chakra)
INCLUDES 7 x wooden beater

4 FLOWER OF LIFE ENERGY CHIME

MATERIAL Silver anodized aluminum alloy
TUNING 2048 Hz / C7
FEATURES Handcrafted masterpiece made in Thailand
 Exact fine tuning
 Heat-branded logo and tuning info
INCLUDES Wooden beater

5 ENERGY CHIME CASE

SIZE For 8 energy chimes
MATERIALS Inner material foam
 Outer material leatherette
FEATURES For safe and easy transportation

& SOUND EFFECTS

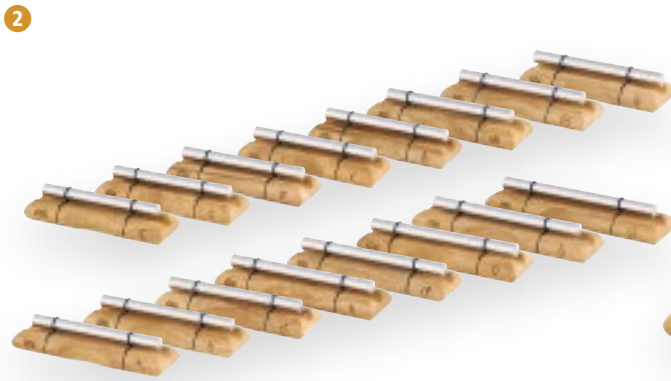

Set, 16 pcs.
EC-SET-16



Set, 7 pcs.
EC-SET-CHA-7



Flower of Life
EC-FOL



ECC-8



TINGSHA

TINGSHA-OR

TINGSHA-8



Small
B-S

Medium
B-M

X-Large
B-XL



MARIMBULA

6 TINGSHAS

SIZES **TINGSHA:** 3.15"
TINGSHA-OR: 3.15"
TINGSHA-8: 2.68"

MATERIAL Special cast alloy

FEATURES Handcrafted masterpiece made in India
Used for meditation

INCLUDES Cotton bag

SYMBOLS **OR:** Ornamental
8: 8 Luck Symbols (Ashtamangala)

8 MARIMBULA

SIZE 23.5" W x 15.75" H x 8.25" D

MATERIALS Siam Oak (*Hevea brasiliensis* Muell.-Arg.)
Steel tongues

TUNING f, c, G, D, F, A, d, g

FEATURE Solid construction
Heavy-duty rubber feet for a solid base

COLOUR Brown

FINISH Matte

7 BELLS

DIMENSIONS **B-S:** Small (2.87"); 280 g
B-M: Medium (3.5"); 355 g
B-XL: X-Large (4.3"); 700 g

MATERIAL Special cast alloy

FEATURES Handcrafted masterpiece made in India
Used for meditation

SOUND EFFECTS



SPCH



SKCH



TMCHBK

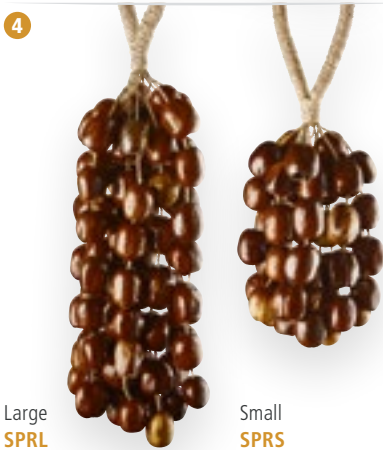

Large
SPRL

Small
SPRS



SPH



SPB



Small
SBRS



Large
SKRL

Small
SKRS



SKH



SKB



Small
SPGRS

1 PALA CHIMES

SIZE 16.7" x 15.7"
MATERIALS Pala seed nutshells
Mahogany wood
FEATURE Pleasant, smooth sound

2 KENARI CHIMES

SIZE 16.7" x 14.6"
MATERIALS Kenari seed nutshells
Mahogany wood
FEATURE Powerful, crisp sound

3 CHIMES STAND

MATERIAL Black powder coated steel
FEATURES Full angle and height adjustability;
Secure angle clamps; Telescoping stem;
Rubber feet to prevent from slipping

4 PALA SHAKERS

SIZES **SPRL:** Large (13.7")
SPRS: Small (11.0")
MATERIAL Pala seed nutshells
FEATURE Pleasant, smooth sound

5 PALA ROD SHAKER

SIZE 9.0"
MATERIAL Pala seed nutshells
FEATURE Pleasant, smooth sound

6 PALA BRACELET

SIZE 3.7" x 2.4"
MATERIAL Pala seed nutshells
FEATURE Pleasant, smooth sound

7 BENDO SHAKER

SIZE 8.3"
MATERIAL Bendo seed nutshells
FEATURE Clear, crisp sound

8 KENARI SHAKERS

SIZES **SKRL:** Large (12.6")
SKRS: Small (9.0")
MATERIAL Kenari seed nutshells
FEATURE Powerful, crisp sound

9 KENARI ROD SHAKER

SIZE 9.0"
MATERIAL Kenari seed nutshells
FEATURE Powerful, crisp sound

10 KENARI BRACELET

SIZE 3.7" x 2.4"
MATERIAL Kenari seed nutshells
FEATURE Powerful, crisp sound

11 PANGI SHAKER

SIZE 8.3"
MATERIAL Pangi seed nutshells
FEATURE Powerful, deep sound

& DIDGERIDOOS

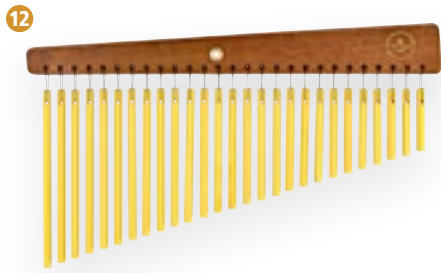

27 bars
CH27WB



Note C, 25.3"
DDPROFZC

Note D, 25.3"
DDPROFZD



Note C, 19.7"
DDPROFSC

Note D, 19.7"
DDPROFSD



16.0"
RS1S

24.0"
RS1M

39.8"
RS1L



Small
TD-S

Large
TD-L



47.2"
DD1BK



Note E, 61.2"
DDPROFPE

Note D, 73.2"
DDPROFNTD

12 CHIMES, 27 BARS

SIZE 27 bars, single row
MATERIALS Jamjuree wood
Gold anodized aluminum alloy
FEATURE Full sound with wide tonal spectrum
COLOUR **WB:** Walnut Brown

13 BAMBOO RAINSTICKS

SIZES **RS1S:** Small (16.0")
RS1M: Medium (24.0")
RS1L: Large (39.8")

MATERIAL Bamboo
FEATURES Lightweight; Dot-painted
COLOUR Black

14 BAMBOO DIDGERIDOO

SIZE 47.2"
MATERIAL Bamboo
FEATURE Dot-painted
COLOUR Black

15 SLICED PRO DIDGERIDOOS

SIZES **DDPROFNTD:** 73.2"
DDPROFPE: 61.2"
MATERIAL Mahogany
TUNING **DDPROFNTD:** D
DDPROFPE: E
FEATURES Screw mechanism to separate into two pieces
DDPROFPE: Dot-painted
INCLUDES Bag
COLOURS **DDPROFNTD:** Natural
DDPROFPE: Black

16 Z-SHAPED PRO DIDGERIDOOS

SIZE 6.3" W x 25.3" H x 2.2" D
MATERIAL Mahogany
TUNING **DDPROFZC:** C
DDPROFZD: D
FEATURE Z-shape offers full tone and volume at a compact size

COLOUR Natural

17 S-SHAPED PRO DIDGERIDOOS

SIZE 11.0" W x 19.7" H x 2.5" D
MATERIAL Mahogany
TUNING **DDPROFSC:** C
DDPROFSD: D
FEATURE S-shape offers full tone and volume at a compact size
COLOUR Natural

18 THUNDER DRUMS

SIZES **TD-S:** Small (7.48")
TD-L: Large (9.84")
MATERIAL Synthetic body
FEATURES Durable construction;
Authentic thunder sounds

FRAME DRUMS

1



Endless Knot, 15"
HOD15-EK



Flower of Life, 15"
HOD15-FOL



Triskele, 15"
HOD15-TR



Venus Flower, 15"
HOD15-VF



Tree of Life, 15"
HOD15-TOL

2



Endless Knot, 16"
HD16WB-EK



Flower of Life, 16"
HD16WB-FOL



Triskele, 16"
HD16WB-TR



Venus Flower, 16"
HD16WB-VF



Tree of Life, 16"
HD16WB-TOL

1 NATIVE AMERICAN-STYLE HOOP DRUMS

- SIZE** 15", 3.2" deep
MATERIALS Hand-selected buffalo head
 Nylon lacing and grip
FEATURES Warm and powerful sound
 Adjustable hand grip
INCLUDES Leather-padded wooden beater
SYMBOLS **EK:** Endless Knot
FOL: Flower of Life
TOL: Tree of Life
TR: Triskele
VF: Venus Flower

2 DESIGNED HAND DRUMS

- SIZE** 16", 2.5" deep
MATERIALS Siam Oak (*Hevea brasiliensis* Muell.-Arg.)
 Hand-selected goat head
FEATURES Warm, rich and resonating tones
 Comfortable grip
SYMBOLS **EK:** Endless Knot
FOL: Flower of Life
TOL: Tree of Life
TR: Triskele
VF: Venus Flower
COLOUR **WB:** Walnut Brown



3



18"
HD18WB

20"
HD20WB

PROFESSIONAL FRAME DRUM BAGS
(SEE PAGE MP.109)



MFDB-14

MFDB-16

MFDB-18

MFDB-20

MFDB-22

4

SYNTHETIC HEAD



18"
HD18WB-WH



5



16"
WD16WB

18"
WD18WB

20"
WD20WB

22"
WD22WB

3 HAND DRUMS

SIZES HD18: 18", 2.5" deep
HD20: 20", 2.5" deep
MATERIALS Siam Oak (*Hevea brasiliensis* Muell.-Arg.)
Hand-selected goat head
FEATURES Comfortable grip
Warm, rich and resonating tones
COLOUR WB: Walnut Brown

4 WOVEN SYNTHETIC HEAD HAND DRUM

SIZE 18", 2.5" deep
MATERIALS Siam Oak (*Hevea brasiliensis* Muell.-Arg.)
Woven synthetic head
FEATURES Comfortable grip
Durable, synthetic head
Rich and resonating tones
COLOUR WB: Walnut Brown

5 WAVE DRUMS

SIZES WD16: 16", 2.5" deep
WD18: 18", 2.5" deep
WD20: 20", 2.5" deep
WD22: 22", 2.5" deep
MATERIALS Siam Oak (*Hevea brasiliensis* Muell.-Arg.)
Hand-selected goat head and synthetic head
FEATURES Sealable filling port allows you to control the amount of steel balls inside
Two different drum heads
Soothing sounds
COLOUR WB: Walnut Brown

Notice: Our frame drums are natural products, different skin textures may occur.

MEINL ONLINE



facebook.com/**meinpercussion**fanpage

facebook.com/**ninopercussion**

facebook.com/**meinlsonicenergy**

instagram.com/**meinpercussion**

instagram.com/**ninopercussion**

instagram.com/**meinlsonicenergy**



youtube.com/**meinpercussion**

youtube.com/**ninopercussion**

youtube.com/**meinlsonicenergy**



twitter.com/**meinpercussion**

twitter.com/**ninopercussion**

twitter.com/**meinlsonic**



meinpercussion.com

ninopercussion.com

meinlsonicenergy.com



DISCLAIMER

All features are subject to change without notice. Not responsible for typographic errors. No part of this book may be reprinted, reproduced, or included in any online service in any form in whole or in part, without the prior permission of MEINL.

© 2023 Roland Meinl Musikinstrumente GmbH & Co. KG

ADVERTISING CONCEPT & DESIGN

ercas GmbH & Co. KG [ercasdieagentur.de]

CONTENT & DIRECTION

Hannes Auerochs, Jim Busch, Lenka Stepanek,
Udo Heubeck, Gabriel Harris, Mitch McMichen

COPYWRITING

Ayrton Gauerke, Jim Busch, Hannes Auerochs,
Lenka Stepanek

PHOTOGRAPHY

Christian Habermeier, Sebastian Jäger, Angelika Jakobs
[studio-waldeck.de]

Miroslav Šmikmátor [smikmatorphoto.com]

Tobias Winklmann, Yannick Steinicke, Danny Lucenara,
Hannes Auerochs, Manuel Burdeus Mendoza, Jan Potsch
Bansbach Instrumentos Musicales

Thomas Bönig, Paul Höppner

Adobe Stock/Kitja

LITHOGRAPHY

Sven Mihm [mihm-werbung.de]

GLOBAL HEADQUARTERS

Roland Meinl Musikinstrumente GmbH & Co. KG
Musik-Meinl-Straße 1
91468 Gutenstetten
Germany

US HEADQUARTERS

MEINL USA L.C.
3427 Ambrose Avenue
Nashville, TN 37207
USA

INVENTORS OF SELECTED PRODUCTS

Bill Saragosa

Dany Moreno

Dominik Rehder

Gilson Batista Da Silveira

José J. Cortijo

Juan Carlos Melian

Marcus Ralph De Mowbray

Mark Allen Johnson

Michael Buchner

Reiko Guthschmidt

Taku Hirano

Torsten Franz

REMO®, Fiberskyn®, Nuskyn® and Skyndeeep®
are registered trademarks of REMO® Inc.
Used by permission.

This catalogue has been printed on
climate neutral paper.

Printed in Germany M-CA151222



